

Regional Benchmarking Report:
*Achievement for a Workforce Region
in a National and International Context*

TIMSS 1999

Southwest Pennsylvania

Third International Mathematics and Science Study • Eighth Grade



Cynthia A. Tananis

Steven J. Chrostowski

Nancy R. Bunt

Marcia M. Seeley

Louis Tamler

TIMSS 1999

Southwest Pennsylvania





Regional Benchmarking Report:
*Achievement for a Workforce Region
in a National and International Context*

TIMSS 1999

Southwest Pennsylvania

Third International Mathematics and Science Study • Eighth Grade

**Charting a
Course to School
Improvement**



Cynthia A. Tananis
Steven J. Chrostowski
Nancy R. Bunt
Marcia M. Seeley
Louis Tamler

Contents

Southwest Pennsylvania Regional Benchmarking Report
TIMSS 1999 – Eighth Grade Mathematics and Science:
Achievement for a Workforce Region in a National and
International Context

by Cynthia A. Tananis, Steven J. Chrostowski, Nancy R.
Bunt, Marcia M. Seeley, Louis Tamler

Publisher: International Study Center
Lynch School of Education
Boston College
Chestnut Hill, MA 02467

Library of Congress
Catalog Card Number: 2002100971

ISBN 1-889938-25-4

For more information about this report, contact:

Math & Science Collaborative
425 Sixth Avenue, Suite 2650
Pittsburgh, PA 15219
412-201-7400
FAX: 412-201-7401
info@collaboratives.org

This report is also available on
the World Wide Web:
<http://www.msc.collaboratives.org>

Funding for the TIMSS 1999 Benchmarking Study was
provided by the National Center for Education Statistics
and the Office of Educational Research and
Improvement of the U.S. Department of Education,
the U.S. National Science Foundation, and participating
jurisdictions. For Southwest Pennsylvania's
participation, funding was provided by The
Grable Foundation, Giant Eagle, the Henry C. Frick
Educational Fund of the Buhl Foundation, the Vira I.
Heinz Endowment, Charles Queenan, and the Richard
King Mellon Foundation.

Boston College is an equal opportunity,
affirmative action employer.

Printed and bound in the United States

1 Executive Summary

- 4 Major Findings
- 6 Implications

7 Chapter 1

Introduction

- 9 What Is TIMSS 1999 Benchmarking?
- 10 Why Did Southwest Pennsylvania Participate?
- 11 Which Countries, States, Districts, and Consortia Participated?
- 12 Exhibit 1.1:
Participants in TIMSS 1999 Benchmarking
- 15 What Was the Nature of the Mathematics and Science Tests?
- 16 Why a Regional Report?
- 17 Why an “Educational Global Positioning System”?
- 17 How Is This Report Organized?
- 18 What Are the Reporting Conventions and Characteristics of Exhibits?

19 Chapter 2

A Tradition: Southwest Pennsylvania Collaboration

- 21 What Is the History of Public-Private Partnership in Southwest Pennsylvania?
- 22 What Was the Origin of the Math & Science Collaborative?
- 22 Exhibit 2.1:
Map of Southwest Pennsylvania Region
- 23 How Is Southwest Pennsylvania Working on Success for the New Century?

27 Chapter 3

Student Achievement in Mathematics and Science

29 How Do Participants Differ in Overall Achievement?

30 Exhibit 3.1:
Average Achievement (Scale Score) in Mathematics

31 Exhibit 3.2:
Average Achievement (Scale Score) in Science

32 How Does Achievement Differ Across Mathematics and Science Content Areas?

33 Exhibit 3.3:
Mathematics Topics Included in TIMSS

34 Exhibit 3.4:
Average Achievement (Scale Score) in Mathematics Content Areas

36 Exhibit 3.5:
Science Topics Included in TIMSS

38 Exhibit 3.6:
Average Achievement (Scale Score) in Science Content Areas

40 How Does Participants' Performance Compare with International Benchmarks of Mathematics and Science Achievement?

43 Exhibit 3.7:
Description of Top 10% TIMSS International Benchmark of Mathematics Achievement

44 Exhibit 3.8:
Top 10% TIMSS International Benchmark of Mathematics Achievement – Example Item 1

45 Exhibit 3.9:
Description of Top 10% TIMSS International Benchmark of Science Achievement

46 Exhibit 3.10:
Top 10% TIMSS International Benchmark of Science Achievement – Example Item 2

47 Exhibit 3.11:
Percentages of Students Reaching TIMSS 1999 Top 10% International Benchmark of Mathematics Achievement

48 Exhibit 3.12:
Percentages of Students Reaching TIMSS 1999 Top 10% International Benchmark of Science Achievement

50 Exhibit 3.13: Description of Upper Quarter TIMSS International Benchmark of Mathematics Achievement

51 Exhibit 3.14:
Upper Quarter TIMSS International Benchmark of Mathematics Achievement – Example Item 3

52 Exhibit 3.15:
Description of Upper Quarter TIMSS International Benchmark of Science Achievement

53 Exhibit 3.16:
Upper Quarter TIMSS International Benchmark of Science Achievement – Example Item 4

54 Exhibit 3.17:
Percentages of Students Reaching TIMSS 1999 Upper Quarter International Benchmark of Mathematics Achievement

55 Exhibit 3.18:
Percentages of Students Reaching TIMSS 1999 Upper Quarter International Benchmark of Science Achievement

57 Exhibit 3.19:
Description of Median TIMSS International Benchmark of Mathematics Achievement

58 Exhibit 3.20:
Median TIMSS International Benchmark of Mathematics Achievement – Example Item 5

59 Exhibit 3.21:
Description of Median TIMSS International Benchmark of Science Achievement

60 Exhibit 3.22:
Median TIMSS International Benchmark of Science Achievement – Example Item 6

62 Exhibit 3.23:
Description of Lower Quarter TIMSS International Benchmark of Mathematics Achievement

62 Exhibit 3.24:
Lower Quarter TIMSS International Benchmark of Mathematics Achievement – Example Item 7

63 Exhibit 3.25:
Description of Lower Quarter TIMSS International Benchmark of Science Achievement

64 Exhibit 3.26:
Lower Quarter TIMSS International Benchmark of Science Achievement – Example Item 8

66 A Focus for Continued Exploration: Gender Differences in Mathematics and Science Achievement

68 Exhibit 3.27:
Average Achievement in Mathematics and Mathematics Content Areas by Gender

70 Exhibit 3.28:
Percentages of Girls and Boys Reaching Each Entity's Own Upper Quarter and Median Levels of Mathematics Achievement

72 Exhibit 3.29:
Average Achievement in Science and Science Content Areas by Gender

75 Exhibit 3.30:
Percentages of Girls and Boys Reaching Each Entity's Own Upper Quarter and Median Levels of Science Achievement



77 **Chapter 4**
The Mathematics and Science Curriculum

- 80 Exhibit 4.1:
Science Subjects Offered Up To and Including Eighth Grade
- 81 What Are the Major Characteristics of the Intended Curriculum?**
- 82 Exhibit 4.2:
Emphasis on Approaches and Processes in Mathematics
- 83 Exhibit 4.3:
Emphasis on Approaches and Processes in Science
- 84 What Content Do Teachers Emphasize at the Eighth Grade?**
- 85 Exhibit 4.4:
Subject Matter Emphasized Most in Mathematics Class
- 87 Exhibit 4.5:
Subject Matter Emphasized Most in Science Class
- 88 What Can Be Learned About the Curriculum?**
- 89 A Focus for Continued Exploration:
*What We Teach and Who We Teach Matters***
- 91 Exhibit 4.6:
Content Tracking in Mathematics and Science

93 **Chapter 5**
Mathematics and Science Instruction

- 95 What Preparation and Confidence Do Teachers Have for Teaching Mathematics or Science?**
- 96 Exhibit 5.1:
Mathematics Teachers' Major Area of Study in Their BA, MA, or Teacher Training Certification Program
- 97 Exhibit 5.2:
Science Teachers' Major Area of Study in Their BA, MA, or Teacher Training Certification Program
- 99 Exhibit 5.3:
Index of Teachers' Confidence in Preparation to Teach Mathematics (CPTM)
- 100 Exhibit 5.4:
Index of Teachers' Confidence in Preparation to Teach Science (CPTS)
- 101 Selected Teaching Strategies in Mathematics and Science**
- 102 Exhibit 5.5:
Index of Teachers' Emphasis on Mathematics Reasoning and Problem-Solving (EMRPS)
- 103 Exhibit 5.6:
Index of Teachers' Emphasis on Scientific Reasoning and Problem-Solving (ESRPS)
- 105 Exhibit 5.7:
Index of Emphasis on Conducting Experiments in Science Class (ECES)
- 107 Exhibit 5.8:
Calculator Use in Mathematics Class
- 108 Exhibit 5.9:
Index of Emphasis on Calculators in Mathematics Class (ECMC)
- 110 Exhibit 5.10:
Index of Teachers' Emphasis on Mathematics Homework (EMH)
- 111 Exhibit 5.11:
Students Doing Various Activities in Mathematics Class
- 112 Exhibit 5.12:
Index of Teachers' Emphasis on Science Homework (ESH)
- 113 Exhibit 5.13:
Students Doing Various Activities in Science Class
- 114 How Do Students Perceive Their Ability in Mathematics and Science?**
- 115 Exhibit 5.14:
Index of Students' Self-Concept in Mathematics (SCM)
- 117 Exhibit 5.15:
Index of Students' Self-Concept in Science (SCS)
- 118 A Focus for Continued Exploration:
*The Complexity of Instruction***





121 Chapter 6

The Role of TIMSS in Regional Initiatives

- 123 **Introducing Educators to TIMSS Findings**
- 125 **Examining TIMSS Findings**
- 126 **Exploring Exemplary Curricular Materials**
- 128 **Supporting Implementation of Exemplary Materials and Instructional Practices**
- 130 **Sharing Successes Around Projects That Have Considered TIMSS**

133 Chapter 7

Next Steps – Implications for Policy and Practice

- 135 **TIMSS Replaces Assumptions with Reality for Southwest Pennsylvania**
- 136 Exhibit 7.1:
Students Eligible to Receive Free/Reduced Price Lunch for Benchmarking Jurisdictions
- 137 Exhibit 7.2:
Index of Home Educational Resources (HER)
- 139 Exhibit 7.3:
Mathematics Achievement by GNP Per Capita for Countries
- 140 Exhibit 7.4:
Science Achievement by GNP Per Capita for Countries
- 141 **TIMSS Is a Guide for Action on Those Realizations**
- 143 **Engage the Whole School to Strengthen Instruction**
- 144 Exhibit 7.5:
Frequency With Which Students Read a Book or Magazine Outside of School
- 143 **Action Steps for Southwest Pennsylvania**

147 Appendix A

Overview of TIMSS Benchmarking Procedures

- 149 **History**
- 149 **How Was the TIMSS 1999 Benchmarking Study Conducted?**
- 150 **Developing the TIMSS 1999 Mathematics and Science Tests**
- 151 Exhibit A.1:
The Three Aspects and Major Categories of the Mathematics Frameworks
- 151 Exhibit A.2:
The Three Aspects and Major Categories of the Science Frameworks
- 152 **TIMSS Test Design**
- 153 Exhibit A.3:
Distribution of Mathematics Items by Content Reporting Category and Performance Category
- 154 Exhibit A.4:
Distribution of Science Items by Content Reporting Category and Performance Category
- 155 **Background Questionnaires**
- 155 **Translation and Verification**
- 156 **Population Definition and Sampling**
- 158 Exhibit A.5:
Coverage of TIMSS 1999 Target Population
- 160 Exhibit A.6:
School Sample Sizes
- 162 Exhibit A.7:
Student Sample Sizes
- 164 Exhibit A.8:
Overall Participation Rates
- 166 **Data Collection**
- 167 **Scoring the Free-Response Items**
- 167 **Data Processing**
- 168 **International Benchmarks of Student Achievement**
- 169 **Additional Information**

171 Appendix B

Resources for Further Information: Contacts and Exemplary Materials

179 Appendix C

Acknowledgments

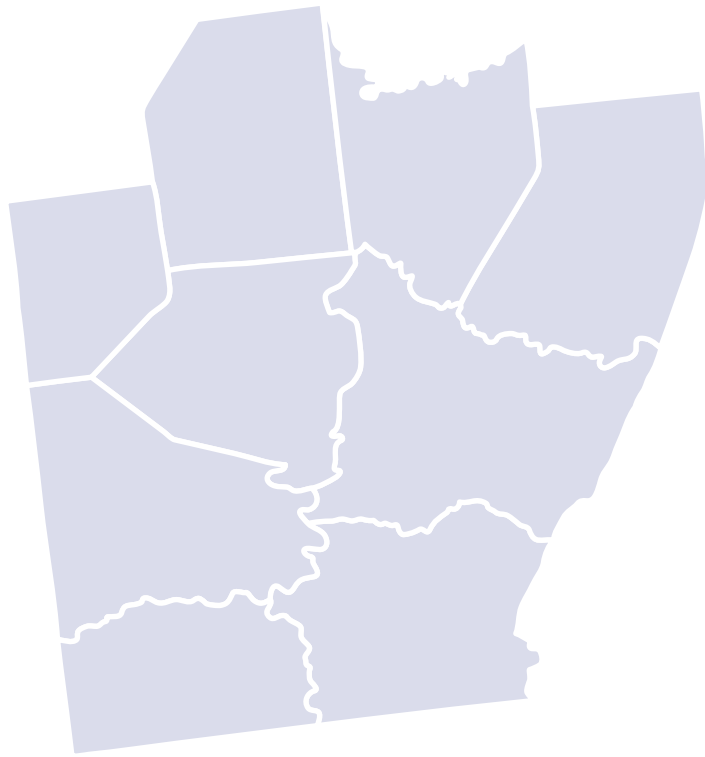

TIMSS 1999

Executive Summary





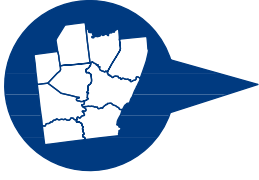

SINCE it was established in 1994, the Math & Science Collaborative has worked to coordinate regional efforts and focus resources on strengthening K-12 mathematics and science teaching and learning in Southwest Pennsylvania. The strongest initiatives for educational improvement in Southwest Pennsylvania have emphasized basing decisions on good data, and have provided opportunities for educators to share their knowledge and experience. Such initiatives value educators as a vital component of curriculum renewal, and link best practices and research in addressing matters of educational concern. Southwest Pennsylvania can take pride in the fact that findings from the 1995 Third International Mathematics and Science Study (TIMSS) have been used in professional development and have informed school districts in curricular decisions such as the selection of instructional materials. Given this experience, when the TIMSS 1999 Benchmarking Study was announced by the International Study Center at Boston College, Southwest Pennsylvania capitalized on the opportunity to collect TIMSS data specific to its region.

In a spirit of public-private collaboration, Southwest Pennsylvania participated as a workforce region in the TIMSS 1999 Benchmarking Study to further its effort to prepare **all** its students to compete successfully in a global society. With this educational “global positioning system” mapping and navigating the region’s achievement in mathematics and science, Southwest Pennsylvania educators can consider mathematics and science teaching and learning through the lens of international, national, state, and regional data. The insight gained can be used to inform policy at the state and local level. Using this close-up picture of regional data, local school districts can focus on ways to strengthen mathematics and science education.

Major Findings

Southwest Pennsylvania results are similar to results for the United States

TIMSS 1999 demonstrates that Southwest Pennsylvania is far more similar than dissimilar to the country as a whole. Southwest Pennsylvania performed similarly to the U.S. in mathematics and significantly above the U.S. in science. Like the U.S., it was significantly above the international average in both mathematics and science. These findings validate the region's extensive use of TIMSS 1995 to inform decisions.

What we teach matters

TIMSS 1999 reinforces the message of TIMSS 1995. A major predictor of student achievement in particular topics is whether that topic is emphasized in the classroom.

- Most eighth-grade students around the world were taught mathematics with an integration of content areas, according to teachers' reports about the subject matter emphasized most in their classes. Internationally on average, more than half the students were taught a combination of mathematics topics (i.e., combined algebra, geometry, number, etc.), and almost one-fifth were in classes emphasizing algebra and geometry combined.
A full 20 percent of students in Southwest Pennsylvania were in classes emphasizing mainly number; in contrast, only 24 percent of students in the region were in classes taught the combination of mathematics topics, and 11 percent were in classes emphasizing algebra and geometry combined. These data suggest that many students in the region continue to be taught number concepts at the eighth grade while their peers in other countries study topics in geometry and algebra.
- There was considerable variation across participants in the reported subject matter emphasis in science classes. Southwest Pennsylvania reported 31 percent of students in classes emphasizing general/integrated science and another 31 percent in classes emphasizing physical science, followed by 18 percent in earth science and 10 percent in biology.

- The descriptions of performance at the international benchmarks of achievement detail what students know and are able to do at the 90th percentile and each quartile of achievement. These descriptions, illustrated by example test questions, along with the percentage of students in Southwest Pennsylvania achieving each benchmark, provide concrete examples of curricular content for educators to consider as they focus on ways to strengthen mathematics and science education.

What we teach to *whom* matters

While what we teach matters, what is taught cannot influence students who do not have adequate and equal access to the curriculum. Who has access to the curriculum matters as well. Especially in mathematics, Southwest Pennsylvania students experience greater levels of content tracking, the provision of different content to different classes, than U.S. students, who in turn face greater levels of content tracking than students internationally. This means there are a greater number of Southwestern Pennsylvania students who do not have access to rigorous mathematics topics.

- In Southwest Pennsylvania, 57 percent of students attended schools that use content tracking as a way of organizing mathematics classes, similar to Pennsylvania with 59 percent. These results indicate far more mathematics content tracking in Pennsylvania and the region compared with the U.S. (37 percent) or the international average (17 percent).
- Content tracking in science was less prevalent, with only 17 percent of students in Southwest Pennsylvania, 25 percent in Pennsylvania, 12 percent in the U.S., and 14 percent internationally in schools that reported using content tracking in science.
- In some jurisdictions, including Southwest Pennsylvania, students in schools reporting no content tracking had higher levels of achievement.
- Gender also plays a role. In mathematics at the eighth grade, there was relatively equivalent average achievement for girls and boys in Southwest Pennsylvania. In contrast, however, in science boys had significantly higher average achievement than girls in the region.

Implications

Several implications for policy and practice are clear. By gaining information from the TIMSS 1999 Benchmarking Study, the region can acknowledge and learn from its similarity to the nation as a whole. It is essential to move beyond predicting achievement by relative wealth or poverty, and to focus on what schools can do to support achievement. Local educators have new evidence to advocate enabling achievement at a higher level for more students through a challenging curriculum for *all* students. They can support the pursuit of coherence in curriculum that builds strategically upon itself, minimizes repetition, and emphasizes essential understandings. Improving students' opportunities to learn requires examining every aspect of the educational system, recognizing that there is no "silver bullet" or single factor that is the answer to raising student achievement in mathematics and science.

Secondary analysis of the TIMSS 1999 data will be important and may add insight. Southwest Pennsylvania is looking forward to the results of a regional curriculum analysis performed by Dr. William Schmidt of the U.S. TIMSS National Research Center at Michigan State University. In particular, Southwest Pennsylvania is interested in looking more closely at the findings for the Michigan Invitational Group, where all districts are using standards-based mathematics materials.

TIMSS is a call to action for K-12 educators to approach the continuous task of strengthening instruction with renewed purpose and vigor. Drawing from this research, educators can explore the numerous ways to approach instruction, and think deeply about which strategies should be used, when, and why. Policy makers can look to the policies and practices of higher-achieving countries and jurisdictions for guidance about how best to support learning and instruction. The value of TIMSS is that it clearly points toward the hard but joyful work needed to implement the strategies by which those improvements are most likely. TIMSS Benchmarking charts a course to school improvement; educators in Southwest Pennsylvania must move along it with the knowledge that every great journey is taken a step at a time.

Chapter 1

Introduction



Marcia M. Seeley, M.Ed.



In this chapter:

- What Is TIMSS 1999 Benchmarking?
- Why Did Southwest Pennsylvania Participate?
- Which Countries, States, Districts and Consortia Participated?
- What Was the Nature of the Mathematics and Science Tests?
- Why a Regional Report?
- Why an “Educational Global Positioning System”?
- How Is This Report Organized?
- What Are the Reporting Conventions and Characteristics of Exhibits?

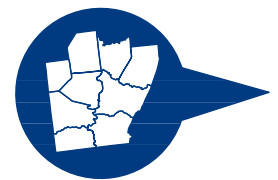

Over the last decade, many states and school districts have created content and performance standards targeted at improving students' achievement in mathematics and science. Since 1989, when the National Council of Teachers of Mathematics (NCTM) published *Curriculum and Evaluation Standards for School Mathematics*,¹ the mathematics education community has had the benefit of a unified set of goals for mathematics teaching and learning. The NCTM standards have been a springboard for state and local efforts to focus and improve mathematics education. Pennsylvania is no exception to this. In January 1999, the Pennsylvania State Board of Education amended the school code to add Chapter 4, relating to academic standards and assessment. Mathematics standards and assessments were included as part of Chapter 4. A similar process began with publication of the *National Science Education Standards* in 1995.² Standards for Science and Technology and for Environment and Ecology have been written for Pennsylvania. These two sets of science standards were adopted in final form by the State Board of Education in July 2001.

What Is TIMSS 1999 Benchmarking?

TIMSS 1999, a successor to the 1995 Third International Mathematics and Science Study (TIMSS), focused on the mathematics and science achievement of eighth-grade students. Thirty-eight countries including the United States participated in TIMSS 1999 (also known as TIMSS-Repeat or TIMSS-R). Significantly for the United States, however, TIMSS 1999 included a voluntary Benchmarking Study. Participation in the TIMSS 1999 Benchmarking Study at the eighth grade provided states, districts, and consortia of districts an unprecedented opportunity to assess the comparative international standing of their students' achievement and evaluate their mathematics and science programs in an international context. As a participant, Southwest Pennsylvania is able to compare its collective regional achievement not only internationally, but with that of the United States as a whole and with the performance of Pennsylvania, since the state also participated in the Benchmarking project.

Originally conducted in 1994-1995,³ TIMSS compared the mathematics and science achievement of students in 41 countries at five grade levels. Using questionnaires, videotapes, and analyses of curriculum materials, TIMSS also investigated the contexts for learning mathematics and science in the participating countries. TIMSS results, which were first reported in 1996, have stirred debate, spurred reform efforts, and provided important information to educators and decision makers around the world. The findings from TIMSS 1999,

1 National Council of Teachers of Mathematics (1989), *Curriculum and Evaluation Standards for School Mathematics*, Reston, VA: NCTM.

2 National Research Council (1995), *National Science Education Standards*, Washington, DC: National Academy Press.

3 TIMSS was administered in the spring of 1995 in northern hemisphere countries and in the fall of 1994 in southern hemisphere countries, both at the end of the school year.

a follow-up to the earlier study, add to the richness of the TIMSS data and their potential to have an impact on policy and practice in mathematics and science teaching and learning.

Twenty-seven jurisdictions from all across the nation, including 13 states and 14 districts or consortia, participated in the Benchmarking Study (see Exhibit 1.1). To conduct the Benchmarking Study, the TIMSS 1999 assessments were administered to representative samples of eighth-grade students in each of the participating districts and states in the spring of 1999, at the same time and following the same guidelines as those established for the 38 countries.

In addition to testing achievement in mathematics and science, the TIMSS 1999 Benchmarking Study involved administering a broad array of questionnaires. TIMSS collected extensive information from students, teachers, and school principals as well as system-level information from each participating entity about mathematics and science curricula, instruction, home contexts, and school characteristics and policies. The TIMSS data provide an abundance of information making it possible to analyze differences in current levels of performance in relation to a wide variety of factors associated with classroom, school, and national contexts within which education takes place.

Why Did Southwest Pennsylvania Participate?

By establishing the Math & Science Collaborative in 1994, well before data were released from the first TIMSS, Southwest Pennsylvania declared its intent to prepare *all* students with the mathematics and science education that they need to be successful. The region recognizes that a skilled workforce will attract and keep the challenging work opportunities that are essential to a high quality of life. Committed to connecting K-12 educators with research and resources, the Collaborative encourages all schools to engage in a quest to strengthen teaching and learning in mathematics and science.

As the end of the twentieth century approached, the Collaborative sought answers to questions. How will Southwest Pennsylvania's students fare in the new century? Will they be prepared with the mathematics and science learning that they need to be successful workers and thoughtful citizens? With the increase in global business opportunities, how does what the region's students learn and how they are taught compare with the experience of students in the rest of the world? In order to benchmark its regional progress, Southwest Pennsylvania participated in this international study in 1999 as though it were its own nation. It was the only Benchmarking jurisdiction to participate as a workforce region, made up of a metropolitan area (Pittsburgh) and nine surrounding counties.⁴ Drawing from all public and private schools in the urban, suburban, and rural settings that contribute to the region's workforce, it became known among the

⁴ The region was originally defined as nine counties including: Allegheny, Armstrong, Beaver, Butler, Fayette, Greene, Indiana, Washington, and Westmoreland counties. In 2000, the Math & Science Collaborative started working with schools in an expanded region of Lawrence and Mercer counties, as well. While the Benchmarking Study did not sample eighth-grade children in these additional counties, we believe the findings are of equal importance to schools in those counties and beyond, as well.

Benchmarking jurisdictions as the “Real World” Consortium. The region sought an educational “global positioning system” helping it examine such questions as:

- How demanding are our curricula and expectations for student learning?
- Is our classroom instruction effective? Is the time provided for instruction being used efficiently?
- Are our teachers well prepared to teach mathematics and science concepts? Can they help students understand mathematics and science?
- Do our schools provide an environment that is safe and conducive to learning?

Which Countries, States, Districts, and Consortia Participated?

Exhibit 1.1 shows the 38 countries, 13 states, and the 14 districts and consortia that participated in TIMSS 1999 and the Benchmarking Study. A subset of these participants (highlighted in the exhibit) has been selected for this report. All exhibits in the report include data from the United States as a whole, the state of Pennsylvania, and the international average. Chinese Taipei, First in the World Consortium, Japan, Korea, Naperville, Netherlands, and Singapore are included because they are high-achievers in both science and mathematics. Canada, England, Japan, and Korea are included because those countries are economic competitors of the United States. Since the Southwest Pennsylvania Math & Science Collaborative has found the TIMSS 1995 video study particularly powerful in its work with schools, those countries that participated in the TIMSS 1999 video study in both science and mathematics (Australia, Czech Republic, and Netherlands) are included. Additionally, some states and consortia have been included because they are of particular interest. The state of Michigan has performance results similar in many ways to that of Southwest Pennsylvania. The Michigan Invitational Group, a subset of Michigan, was selected because of its interest in the use of National Science Foundation materials, an interest that the Southwest Pennsylvania Math & Science Collaborative shares. As a neighbor across the state border, Project SMART Consortium was also selected.

Exhibit 1.1: Participants in TIMSS 1999 Benchmarking

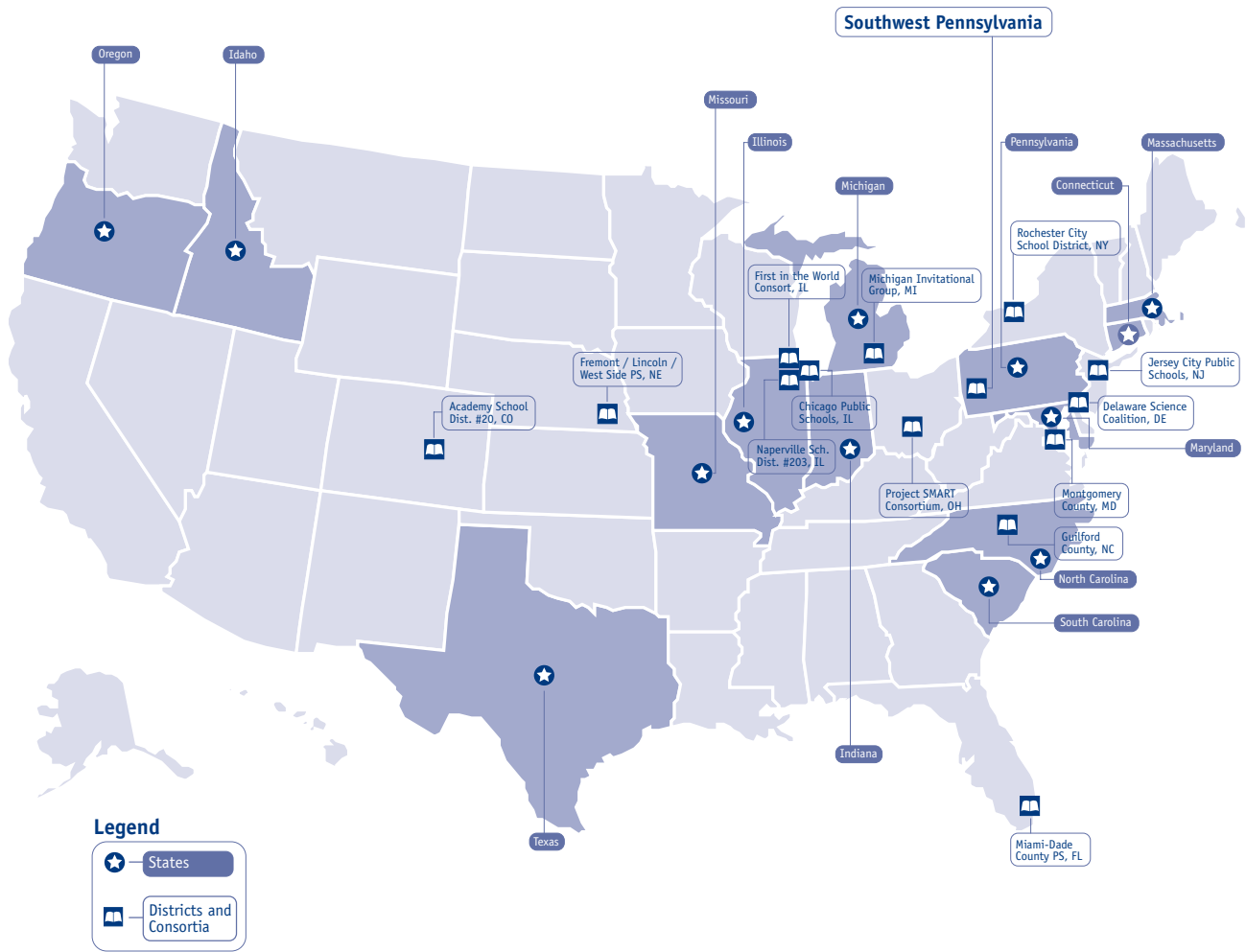

SOURCE: IEA Third International Mathematics and Science Study (TIMSS) 1998-1999

| States |
|---------------------|
| Connecticut |
| Idaho |
| Illinois |
| Indiana |
| Maryland |
| Massachusetts |
| Michigan |
| Missouri |
| North Carolina |
| Oregon |
| Pennsylvania |
| South Carolina |
| Texas |

| Districts and Consortia |
|---|
| Academy School District #20, Colorado Springs, CO |
| Chicago Public Schools, IL |
| Delaware Science Coalition, DE |
| First in the World Consortium, IL |
| Fremont/Lincoln/West Side Public Schools, NE |
| Guilford County, NC |
| Jersey City Public Schools, NJ |
| Miami-Dade County Public Schools, FL |
| Michigan Invitational Group, MI |
| Montgomery County, MD |
| Naperville Community Unit School District #203, IL |
| Project SMART Consortium, OH |
| Rochester City School District, NY |
| SOUTHWEST PENNSYLVANIA |

| Countries |
|---------------------------|
| Australia |
| Belgium (Flemish) |
| Bulgaria |
| Canada |
| Chile |
| Chinese Taipei |
| Cyprus |
| Czech Republic |
| England |
| Finland |
| Hong Kong, SAR |
| Hungary |
| Indonesia |
| Iran, Islamic Republic |
| Israel |
| Italy |
| Japan |
| Jordan |
| Korea, Republic of |
| Latvia (LSS) |
| Lithuania |
| Macedonia, Republic of |
| Malaysia |
| Moldova |
| Morocco |
| Netherlands |
| New Zealand |
| Philippines |
| Romania |
| Russian Federation |
| Singapore |
| Slovak Republic |
| Slovenia |
| South Africa |
| Thailand |
| Tunisia |
| Turkey |
| United States |

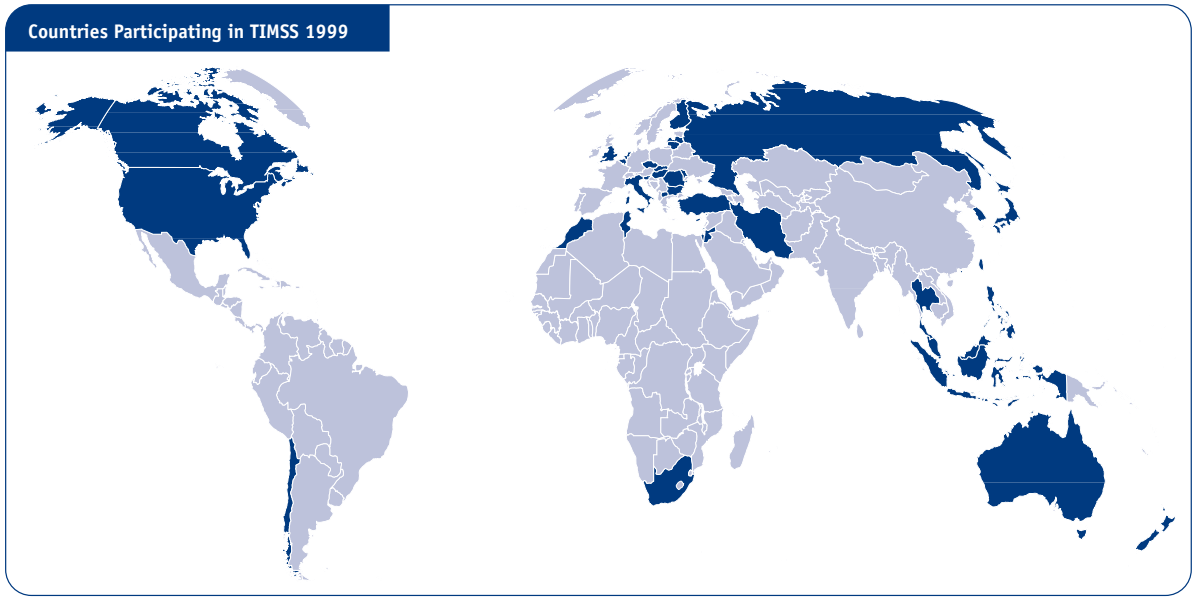

The consortia (including Southwest Pennsylvania) consist of groups of entire school districts or individual schools from several districts that organized together either to participate in the Benchmarking Study or to collaborate across a range of educational issues. Descriptions of the consortia included in our comparison group follow.

First in the World Consortium. The First in the World Consortium consists of a group of 18 districts from the North Shore of Chicago that have joined forces to bring a world-class education to the region's students and to improve mathematics and science achievement in their schools. Resulting from meetings of district superintendents in 1995, the consortium decided to focus on three main goals: benchmarking its performance to educational standards through participating in the original TIMSS in 1996⁵ and again in 1999; creating a forum to share the vision with businesses and the community of benchmarking to world-class standards; and establishing a network of learning communities of teachers, researchers, parents, and community members to conduct the work needed to achieve their goal.

Michigan Invitational Group. The Michigan Invitational Group is a heterogeneous and socioeconomically diverse group composed of urban, suburban, and rural schools across Michigan. Schools invited to participate as part of this consortium were those that were using National Science Foundation materials, well-developed curricula, and provided related staff development to teachers.

Project SMART Consortium. SMART (Science & Mathematics Achievement Required for Tomorrow) is a consortium of 30 diverse school districts in northeast Ohio committed to continuous improvement, long-term systemic change, and improved student learning in science and mathematics in grades K-12. It is jointly funded by the Ohio Department of Education and the Martha Holden Jennings Foundation. The schools that participated in the study represent 17 of the 30 districts.

The results for the 38 countries participating in TIMSS 1999 and for the 27 jurisdictions participating in the TIMSS 1999 Benchmarking Study were reported in two companion reports – the *Mathematics Benchmarking Report* and the *Science Benchmarking Report*.⁶ This report is designed to highlight and present secondary analyses of the data originally summarized in these two reports. Readers should familiarize themselves with these two reports to draw full meaning from the Benchmarking Study. Performance in the United States relative to that of other nations was reported by the U.S. National Center for Education Statistics in *Pursuing Excellence*.⁷ The results for the United States in those reports, as well as in this report, were based on a nationally representative sample of eighth-grade students drawn in accordance with TIMSS guidelines for all participating countries.

Because having valid and efficient samples in each country is crucial to the quality and integrity of TIMSS, procedures and guidelines have been developed to ensure that the national samples are of the highest quality possible. Following the TIMSS guidelines, representative samples were also

5 Data collection in First in the World Consortium schools took place in 1996, one year after the national data collection.

6 Mullis, I.V.S., Martin, M.O., Gonzalez, E.J., O'Connor, K.M., Chrostowski, S.J., Gregory, K.D., Garden, R.A., and Smith, T.A. (2001), *Mathematics Benchmarking Report, TIMSS 1999 – Eighth Grade: Achievement for U.S. States and Districts in an International Context*, Chestnut Hill, MA: Boston College; Martin, M.O., Mullis, I.V.S., Gonzalez, E.J., O'Connor, K.M., Chrostowski, S.J., Gregory, K.D., Smith, T.A., and Garden, R.A. (2001), *Science Benchmarking Report, TIMSS 1999 – Eighth Grade: Achievement for U.S. States and Districts in an International Context*, Chestnut Hill, MA: Boston College.

7 Gonzales, P., Calsyn, C., Jocelyn, L., Mak, K., Kastberg, D., Arafeh, S., Williams, T., and Tsen, W. (2000), *Pursuing Excellence: Comparisons of International Eighth-Grade Mathematics and Science Achievement from a U.S. Perspective, 1995 and 1999*, NCES 2001-028, Washington, DC: National Center for Education Statistics.

drawn for the Benchmarking entities. Sampling statisticians at Westat, the organization responsible for sampling and data collection for the United States, worked in accordance with TIMSS standards to design procedures that would coordinate the assessment of separate representative samples of students within each Benchmarking entity.

The first challenge for the Southwest Pennsylvania Math & Science Collaborative was to meet the high international participation standards so its findings could be considered representative of the total region. Drawn from a list of all schools with eighth grade in the nine counties, 50 schools were selected by the sampling statisticians at Westat to be a representative sample. However, unlike other jurisdictions, the Southwest Pennsylvania Collaborative was not a district or state that could require participation of the selected schools, or a voluntary consortium working with only those schools that “were willing.” The region’s partnerships to encourage participation drew national attention. Business and civic leaders joined educational leaders including administrators, teachers’ unions, school boards, and parent teacher associations to endorse TIMSS 1999 participation in a widely distributed promotional brochure. On behalf of the region, enough (39) of the selected schools added this study to their already very full schedules to enable our results to be statistically representative of all eighth-grade students throughout the region.

What Was the Nature of the Mathematics and Science Tests?

The TIMSS curriculum frameworks developed for 1995 were also used for 1999. They describe the content dimensions for the TIMSS tests as well as the performance expectations (behaviors that might be expected of students in school mathematics and science).⁸

The TIMSS 1999 mathematics test contained 162 items representing a range of mathematics topics and skills. Five content areas were covered in the TIMSS 1999 mathematics test. These areas and the percentage of the test items devoted to each are fractions and number sense (38 percent), measurement (15 percent), data representation, analysis, and probability (13 percent), geometry (13 percent), and algebra (22 percent). The performance expectations include knowing (19 percent), using routine procedures (23 percent), using complex procedures (24 percent), investigating and solving problems (31 percent), and communicating and reasoning (2 percent).

The TIMSS 1999 science test contained 146 items representing a range of science topics and skills. Six content areas were covered in the TIMSS 1999 science test. These areas and the percentage of the test items devoted to each are earth science (15 percent), life science (27 percent), physics (27 percent), chemistry (14 percent), environmental and resource issues (9 percent), and scientific inquiry and the nature of science (8 percent). The performance expectations include understanding simple information (39 percent), understanding complex information

⁸ Robitaille, D.F., McKnight, C.C., Schmidt, W.H., Britton, E.D., Raisen, S.A., and Nicol, C. (1993), *TIMSS Monograph No. 1: Curriculum Frameworks for Mathematics and Science*, Vancouver, BC: Pacific Educational Press.

(31 percent), theorizing, analyzing, and solving problems (19 percent), using tools, routine procedures, and science processes (7 percent), and investigating the natural world (4 percent).

The test items were developed through a cooperative and iterative process involving the National Research Coordinators (NRCs) of the participating countries. All of the items were reviewed thoroughly by subject matter experts and field tested. Nearly all the TIMSS 1999 countries participated in field testing with nationally representative samples, and the NRCs had several opportunities to review the items and scoring criteria.

About one-fourth of the questions were in the free-response format, requiring students to generate and write their answers. These questions, some of which required extended responses, were allotted about one-third of the testing time. Responses to the free-response questions were evaluated to capture diagnostic information, and some were scored using procedures that permitted partial credit.

Testing was designed so that no one student took all the items, which would have required more than three hours of testing time. Instead, the test was assembled in eight booklets, each requiring 90 minutes to complete. Each student took only one booklet, and the items were rotated through the booklets so that each item was answered by a representative sample of students.

Why a Regional Report?

Educators attending Network Connections, a semi-annual conference held by the Southwest Pennsylvania Math & Science Collaborative, were asked why our region would want to participate in TIMSS 1999 Benchmarking. One participant wrote, *“This region recognizes the importance of math and science to children, not only as informed citizens but also in developing crucial life skills. TIMSS-R allows us as educators to focus our efforts in math and science. A crucial factor in our ability to sell our region to business and industry is to provide a high-quality workforce. TIMSS and TIMSS-R give us a chance to provide the best view possible of our success as a region.”*

All public and private schools with eighth-grade classes in the nine-county region were part of the sample. The International Study Center at Boston College had responsibility for the overall coordination and management of the TIMSS 1999 Benchmarking Study. Schools and students in our region were selected according to the same sampling guidelines used in the international study to be representative of the whole region.

Individual school names are confidential. Since only students from selected classes at any one school participated and since no individual student responded to all test items, data collected from each site are **not** representative of that school. However, the sample as a whole is representative of Southwest Pennsylvania, and there are a number of ways that TIMSS Benchmarking findings can be useful to schools in the region.

Why an “Educational Global Positioning System”?

Using information from satellites, the Global Positioning System (GPS) is able to show you your exact position on the Earth any time, in any weather, anywhere. Aircraft, ships, tanks, submarines, cars, and trucks may be equipped with GPS to assist them in navigation. In a similar way, participation in TIMSS 1999 has given Southwest Pennsylvania its own educational GPS to map and navigate its achievement in mathematics and science. The international reports provide results from 38 countries. The Benchmarking reports provide state-level results as well as results for districts and consortia. Thus, Southwest Pennsylvania schools can consider mathematics and science teaching and learning through the lens of international, national, and state data. Taking a close-up picture of regional data, local school districts can focus on ways to strengthen mathematics and science instruction.

Global findings can be used for local improvement in many ways. Schools can examine TIMSS 1999 released items to see if the test consists of important mathematics and science. By looking at curriculum, instruction, and achievement through an international lens, local districts can note areas of strength and weakness. Schools can examine their curriculum for focus and coherence across grade levels to enable them to meet rigorous international eighth-grade expectations. Schools can look at sub-test scores to note where they might strengthen instruction. They can look at school context issues such as amount of class time, access to computers, amount of homework, and so on to determine which factors may be causing variations

in achievement. They can use these data to question their assumptions about instruction and learning. Professional development can be organized to answer questions raised by the data.

Again, a response from Network Connections addresses why a regional report of TIMSS Benchmarking would be useful to schools: *“As educators, we are able to respond to the data gathered by honing the educational practices that provide success for students, as well as taking a hard look at the practices that may not be as successful.”*

How Is This Report Organized?

This report is organized in seven chapters. Following the introduction in chapter 1, chapter 2 provides background on Southwest Pennsylvania and the history of collaboration in the region. Chapter 3 includes the TIMSS 1999 achievement results for the region, including descriptions of the international benchmarks of achievement with example test items. An area of focus for these findings takes a look at gender issues. Chapter 4 examines curriculum, with an area of focus examining the use of exemplary materials and content tracking. Chapter 5 focuses on instruction, with an area of focus looking at the complexity of instruction. Chapter 6 discusses initiatives that the Math & Science Collaborative has taken in response to the TIMSS 1995 and TIMSS 1999 findings, while chapter 7 addresses next steps and implications for policy and practice. Supporting technical information and resources are included in the appendices.

What Are the Reporting Conventions and Characteristics of Exhibits?

When presenting data in exhibits, two basic conventions are used:

- When the nature of the data allow for a test of statistical significance, data are represented for all countries and jurisdictions that participated in TIMSS 1999 (38 countries including the U.S., and 27 Benchmarking jurisdictions within the U.S., including Southwest Pennsylvania). The countries and jurisdictions are listed in three “bands”: those participants who significantly outperformed Southwest Pennsylvania, those participants whose performance was statistically similar to Southwest Pennsylvania, and those participants who scored significantly below our regional performance. These “bands” of significant difference are based on a test of statistical significance across the entire distribution of TIMSS 1999 participants. Within each of the “bands” referred to above, participants are listed alphabetically since many of the within-band differences in scores are not substantial enough to claim to be beyond the range of sampling error. For this reason, we encourage readers to pay more attention to the placement in the “bands” rather than numeric scale scores which are limited in their ability to discriminate performance depending on sample size and other characteristics of the distribution. Keep in mind, Southwest Pennsylvania will always be in the “middle band” in these exhibits because the statistical analyses were designed to ask the question, “How do the other participants (countries and jurisdictions) perform in relation to Southwest Pennsylvania?”

- When a test of significance is less important or useful, for example in describing non-achievement data, the exhibits are limited to the distribution of data for Southwest Pennsylvania and the “comparator” countries and jurisdictions selected for the purpose of this report (see “Which Countries, States, Districts, and Consortia Participated?” in chapter 1 for a complete description of the comparators). In the exhibits described above that include all the participants, the comparator countries and jurisdictions are presented in boldface type for easier location.

For information beyond that contained in this regional report, visit <http://timss.bc.edu> to view or order the full mathematics and science Benchmarking reports.

Chapter 2

**A Tradition:
Southwest Pennsylvania Collaboration**



Nancy R. Bunt, Ed.D.





In this chapter:

- What Is the History of Public-Private Partnership in Southwest Pennsylvania?
- What Was the Origin of the Math & Science Collaborative?
- How Is Southwest Pennsylvania Working on Success for the New Century?

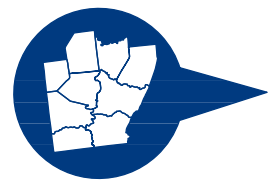

Southwest Pennsylvania has a rich history of public-private partnership focused on improving quality of life. It is characterized by private and public leaders who are willing to acknowledge tough realities and partner in order to move the region forward.

What Is the History of Public-Private Partnership in Southwest Pennsylvania?

In his book, *Pittsburgh*, Stefan Lorant details the region's experience after World War Two. Congratulations were widespread for the vital role that the region surrounding and including Pittsburgh had played in providing the industrial muscle to achieve victory through its steel mills and chemical and glass making industries. However, it was also apparent that, given a choice, no one would choose to live in the polluted, flood-prone region that resembled "hell with the lid off." Inspired by a strong loyalty to the region, the industrial leadership, led by Richard King Mellon, joined forces to form a non-profit leadership organization, the Allegheny Conference on Community Development. It convened the C.E.O.s of the industrial concerns and research universities as an executive committee to confer on appropriate strategies and partner with government via then mayor, and later governor, David L. Lawrence. The Pittsburgh industrial leadership at that time was substantial. Pittsburgh ranked third in the nation in housing corporate headquarters, including such well known names as Alcoa, Gulf Oil, Heinz, Koppers, Mellon Bank, Pittsburgh Plate Glass, US Steel, Westinghouse and others. The result of that early partnership came to be known

as the first Pittsburgh Renaissance, characterized by a considerable decline in air pollution, the end of annual flooding, and the creation of the Golden Triangle of downtown development and an unsurpassed county park system.

In 1999, *City Schools & City Politics, Institutions and Leadership in Pittsburgh, Boston and St. Louis* described the continuing public-private partnership and its impact on education. In the late 1960s, partially prompted by the racial unrest following the assassination of Martin Luther King, Jr., the Allegheny Conference recognized the key importance of public education to quality of life in the region. Its leadership worked with the leadership of Pittsburgh Public Schools and the Pittsburgh Federation of Teachers to craft a desegregation plan acceptable to the Human Relations Commission. One major result was that Pittsburgh avoided court supervision of the educational system, which while necessary in many cities to accomplish desegregation, added tremendous, often unproductive, bureaucracy to most other urban school systems in the country.

Another major result of that ad hoc partnership was the formal development of the Allegheny Conference Education Fund, which acted entrepreneurially to use private sector funds to strengthen public education, through such strategies as Minigrants for Teachers and school-business partnerships. Its success was noted by the Ford Foundation, which funded the creation of the Public Education Fund, to encourage establishment of similar efforts across the nation. With 50+ cities taking advantage of that approach, the Public

Education Fund Network was established early in the 1990s, and re-located to Washington, to share strategies to strengthen public education through partnerships with the private sector.

Also in the early 1990s, recognizing that strengthening public education required the involvement of leaders from other sectors as well as business and industry, the Allegheny Conference spun off its Education Fund to create an organization solely focused on strengthening public education through cross-sector mobilization, the Allegheny Policy Council. Organized around the nascent National Education Goals, its board added the leadership of city and county government and public school superintendents to the business leadership appointed by the Allegheny Conference.

What Was the Origin of the Math & Science Collaborative?

In 1994, as one of its first efforts, the Allegheny Policy Council led a planning initiative focused on how Southwest Pennsylvania could coordinate efforts and focus resources on strengthening mathematics and science in K-12 education. At the suggestion of the local philanthropic community in the Pittsburgh metropolitan area, a congress with representatives of all 43 school districts in Allegheny County and representatives of 50+ regional resources, such as the museums, universities, and non-profits, came together to consider how they might work together to strengthen mathematics and science teaching and learning in Southwest Pennsylvania.

The founding congress agreed on the importance of working together and established the Math & Science Collaborative with three priority goals: (1) to enable student access to appropriate technology for learning mathematics and science,

Exhibit 2.1: Map of Southwest Pennsylvania Region

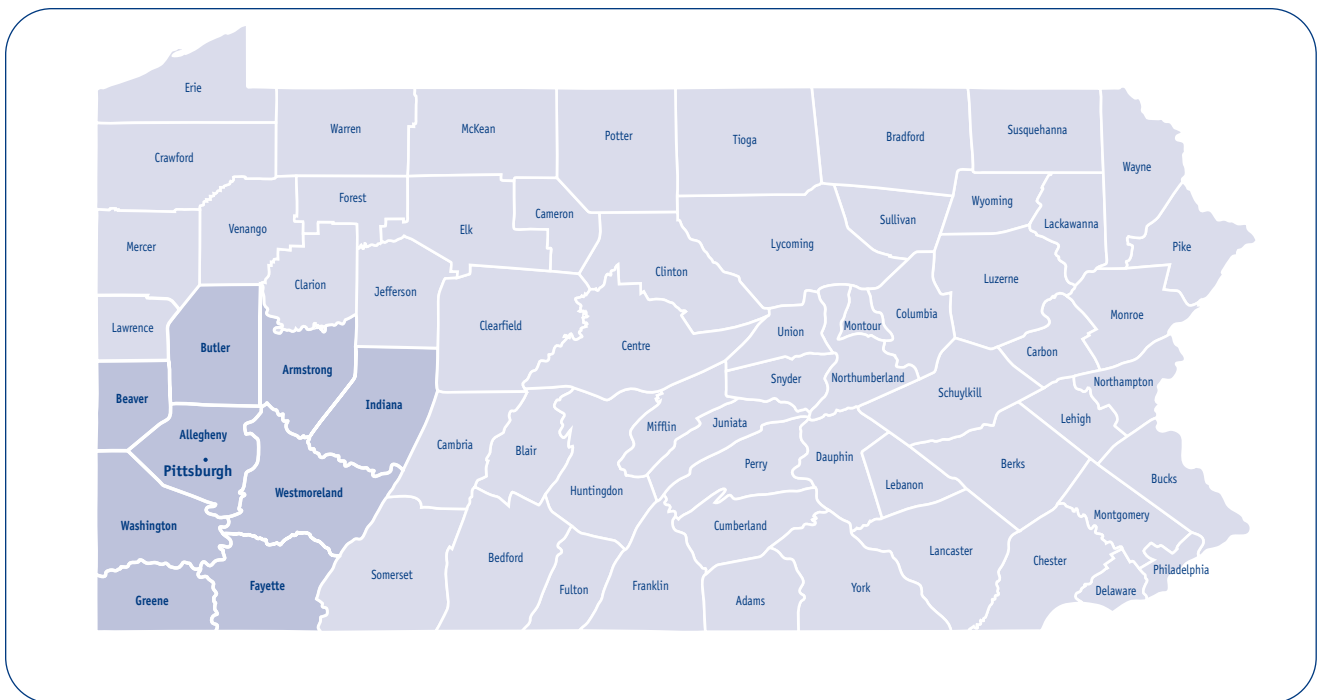

(2) to act as a clearinghouse for exemplary curriculum and assessments, and (3) to coordinate the provision of quality professional development for K-12 educators. The congress also recommended that the home of the new Collaborative be Carnegie Museums of Pittsburgh, to allow it to operate outside the governmental structure of the public schools within a non-profit organization, continuing the tradition of public-private partnership. In the fall of 1994, the Collaborative established networks of regional educational leaders appointed by their districts and resource partners described further in chapter 6. Having begun with the 43 school districts in Allegheny County in 1994, its work now involves 140 school districts over an 11-county area comprising the entire workforce region of Southwest Pennsylvania.

How Is Southwest Pennsylvania Working on Success for the New Century?

Renewed Collaboration for Economic Development

In 1994, at the same time as the Math & Science Collaborative was being established, the Allegheny Conference was struggling with the economic realities facing Southwest Pennsylvania. The number of corporate headquarters in Pittsburgh was decreasing rapidly, coupled with substantial loss of jobs in heavy industry, changing the face of the region dramatically. The Conference facilitated a Regional Economic Revitalization Initiative process that resulted in an aggressive agenda for the region's future with a target of the creation of 100,000 new jobs in the region by the year 2000. When that agenda was presented to the community on November 17, 1994, it was also recommend-

ed that a "Working Together Consortium" be established to monitor the implementation of the recommended actions, assess the region's economic vitality, and report progress to the community. The WTC is a group of civic leaders who have agreed on a volunteer basis to monitor and review the implementation of the Action Recommendations in the Working Together Report. Its purpose is twofold: it provides accountability as to the progress of the Action Recommendations, and it enables renewal of those Action Recommendations based on progress, evaluation, and changing needs. Twelve initiatives were proposed in 1994 for the WTC. By 2000, they were consolidated into six broad thematic categories: (1) Business and Job Development, (2) Economic Climate for Job Creation, (3) Infrastructure Investment, (4) Human Capital, (5) Building One Economy, and (6) Regional Marketing.

Economic Development Tied to Math/Science Education

Under the theme of Human Capital, in 1994 the Math & Science Collaborative was designated the leadership agency to undertake the initiative to "Make Southwestern PA Graduates #1 in Math and Science." When the opportunity arose in 1998 for participation in TIMSS Benchmarking, it was the Working Together Consortium's Vice Chair for Human Capital who tapped business and foundation leadership to consider the opportunity, and financially enable participation by Southwest Pennsylvania. Four foundations and an individual stepped up to the table to provide the funding for participation and follow-up. They included the

Buhl Foundation, The Grable Foundation, The Heinz Endowments, the Richard King Mellon Foundation, and Charles Queenan, now Chair of the Allegheny Conference. The result was the addition of another initiative under the Working Together Consortium's Human Capital Theme, enabling participation in the TIMSS 1999 Benchmarking Study.

Continuing the tradition begun at the end of World War Two, of a commitment to the gathering of realistic information about the status of the region, the Working Together Consortium released its Final Progress Report on June 22, 2001. As noted in the cover letter by its chairman, it documents the bottom line: how did our regional economy change over the period 1994-2000, and how did the work of the Consortium correlate to actual quantifiable results? The Consortium acknowledges that only 85,100 net new jobs were created since 1994, but notes that the region is visibly moving forward, and WTC has been an important contributor to the continuing economic growth.

In that same manner, the Math & Science Collaborative continues its work, as further detailed in chapter 6, to publicize and connect the many efforts throughout Southwest Pennsylvania that can help strengthen teaching and learning in mathematics and science. Supported by 13 local foundations, as well as several federal grants, its work continues the tradition of gathering good information about the existing conditions to inform future steps.

Expanding the Focus of Collaboration: Collaboratives for Learning

Since February of 2000, the **Math & Science Collaborative** has been joined by two other initiatives, the **School Performance Network** and the **Arts Education Collaborative**, to comprise the Collaboratives for Learning. Their shared mission is to engage K-12 schools in strengthening teaching and learning in Southwest Pennsylvania by connecting enterprising schools, research, and resources. The work of Collaboratives with schools and partners is characterized as:

- Research-based, data-driven, and focused on what works
- Understanding and respecting the environment in which schools operate
- Focusing on sustainable improvements that will not require substantial future resources
- Strengthening the professional development and strategic planning skills of educators
- Acting as the catalyst that will create success for all children.

The Arts Education Collaborative is a unique model for improving education in, with, and through the arts that has drawn heavily from the experience of the Math & Science Collaborative. Heightened local and national awareness of the importance and value of arts education, bolstered by growing research-based evidence, created momentum for such an initiative. Recognizing the

need for a systematic approach to arts education involving the full range of concerned constituents, in 1998 The Heinz Endowments and The Grable Foundation, with the guidance of a representative Sounding Board, decided to convene an Arts Education Congress to formulate a strategic joint action agenda to advance arts education in the region and define a structure to carry this agenda forward. In November of 1998, focusing on arts in education, nearly 300 superintendents, teachers, school board members, parents, students, artists and cultural organizations, representatives from colleges and universities, and funders deliberated a joint action agenda. They identified the need for coordinated professional development, state standards in arts education, and ongoing public relations efforts to enhance understanding of the value of arts education as priority foci for a future regional coordinating entity. With full-time staff, and established Networks of Educators and Resource Partners, the Arts Education Collaborative is positioned to strengthen student creativity and achievement in, with, and through the arts.

The third collaborative is the School Performance Network (SPN). Established in 2000, it focuses on systemic change involving the entire school. SPN works with schools committed to the principles of total school performance:

- Learning...achieving high standards
- Results...driven by performance based information
- Resources...used strategically to improve results
- Culture...that supports collective effort and accountability
- Partners...that enhance and extend student learning opportunities

SPN offers learning opportunities such as Forums, study groups, and regional clusters to enable educators to access research and resources as they pursue their commitment to bring these principles to life within their schools.

Collaboratives for Learning embodies the Southwest Pennsylvania belief that “by working together, we can do better” – as as an organization, as educators, as schools, and as a region.

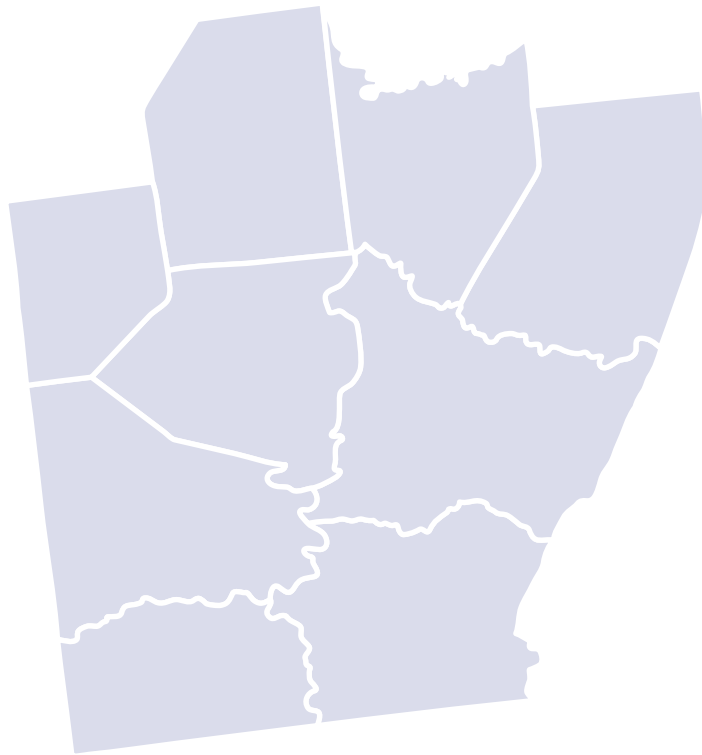

Chapter 3

Student Achievement in Mathematics and Science



Cynthia A. Tananis, Ed.D.

Steven J. Chrostowski, Ed.M.





In this chapter:

- How Do Participants Differ in Overall Achievement?
- How Does Achievement Differ Across Mathematics and Science Content Areas?
- How Does Participants' Performance Compare with International Benchmarks of Mathematics and Science Achievement?

A Focus for Continued Exploration

**Gender Differences in Mathematics
and Science Achievement**

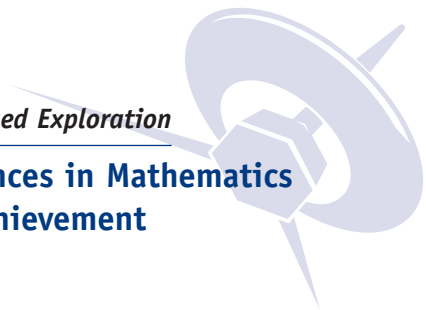

Chapter 3 summarizes eighth-grade achievement on the TIMSS 1999 Benchmarking mathematics and science assessments. Descriptions of overall achievement, achievement in the specific content areas within mathematics and science, and the region’s performance against internationally scaled benchmarks are all provided. The chapter concludes with a focus on gender-related differences in performance in both mathematics and science.

How Do Participants Differ in Overall Achievement?

Exhibits 3.1 and 3.2 present the distribution of student achievement for the 38 TIMSS 1999 countries and the 27 Benchmarking participants for mathematics and science via “bands” of statistically significant difference.¹ Each exhibit has three columns comparing averages to Southwest Pennsylvania, indicating those that scored significantly higher, not significantly different, and significantly lower. Many of the countries and jurisdictions within each band do not differ significantly from each other (the differences in their numeric averages do not represent differences attributed beyond “chance” or random variation), and are therefore presented alphabetically.

Many of the Benchmarking participants performed fairly well on the TIMSS 1999 mathematics and science assessments. Average performance for the 13 Benchmarking states was clustered in the middle of the international distribution of results for the 38 countries for mathematics and in the upper half for science. All of the Benchmarking states performed either significantly above or similar to the international average in mathematics,

and all but three in science. The United States as a whole also had average mathematics and science achievement just above the international average.

The Benchmarking Study underscores the extreme importance of looking beyond the averages to the range of performance found across the nation. Performance across the participating school districts and consortia reflected nearly the full range of achievement internationally. The two highest-achieving Benchmarking participants were the Naperville School District and the First in the World Consortium. These were two of the Benchmarking participants with the lowest percentages of students from low-income families (Naperville, 2 percent; First in the World, 14 percent).² Benchmarking participants with the lowest average mathematics and science achievement included four urban school districts with high percentages of students from low-income families – the Jersey City Public Schools (89 percent), the Chicago Public Schools (71 percent), the Rochester City School District (73 percent), and the Miami-Dade County Public Schools (59 percent). Although not as low as the lowest-scoring countries in TIMSS 1999, the range of average performance across the Benchmarking districts and consortia was almost as broad as across all the TIMSS 1999 countries.

When comparing the performance of TIMSS 1999 countries and Benchmarking jurisdictions in science (Exhibit 3.2), only Naperville School District significantly outscored Southwest Pennsylvania. In mathematics (Exhibit 3.1), the region was only significantly outperformed by the

1 See the section on “Reporting Conventions and Characteristics for Exhibits” in chapter 1.

2 Low-income figures are percentages of students eligible to receive free or reduced-price lunch through the National School Lunch Program, as reported by participating schools.

| Average Significantly Higher Than SW PA Average ▲ | Average Not Significantly Different From SW PA Average ○ | Average Significantly Lower Than SW PA Average ▼ |
|---|--|--|
| Belgium (Flemish) † 558 (3.3) | Academy School Dist. #20, CO 528 (1.8) | Chicago Public Schools, IL 462 (6.1) |
| Chinese Taipei 585 (4.0) | Australia 525 (4.8) | Chile 392 (4.4) |
| First in the World Consort., IL 560 (5.8) | Bulgaria 511 (5.8) | Cyprus 476 (1.8) |
| Hong Kong, SAR † 582 (4.3) | Canada 531 (2.5) | Indonesia 403 (4.9) |
| Japan 579 (1.7) | Connecticut 512 (9.1) | Iran, Islamic Rep. 422 (3.4) |
| Korea, Rep. of 587 (2.0) | Czech Republic 520 (4.2) | Israel ² 466 (3.9) |
| Naperville Sch. Dist. #203, IL 569 (2.8) | Delaware Science Coalition, DE 479 (8.9) | Italy 479 (3.8) |
| Singapore 604 (6.3) | England † 496 (4.1) | Jersey City Public Schools, NJ 475 (8.6) |
| | Finland 520 (2.7) | Jordan 428 (3.6) |
| | Fremont/Lincoln/WestSide PS, NE 488 (8.2) | Lithuania †† 482 (4.3) |
| | Guilford County, NC ² 514 (7.7) | Macedonia, Rep. of 447 (4.2) |
| | Hungary 532 (3.7) | Miami-Dade County PS, FL 421 (9.4) |
| | Idaho 495 (7.4) | Moldova 469 (3.9) |
| | Illinois 509 (6.7) | Morocco 337 (2.6) |
| | Indiana † 515 (7.2) | Philippines 345 (6.0) |
| | Latvia (LSS) ¹ 505 (3.4) | Rochester City Sch. Dist., NY 444 (6.5) |
| | Malaysia 519 (4.4) | Romania 472 (5.8) |
| | Maryland 495 (6.2) | South Africa 275 (6.8) |
| | Massachusetts 513 (5.9) | Thailand 467 (5.1) |
| | Michigan 517 (7.5) | Tunisia 448 (2.4) |
| | Michigan Invitational Group, MI 532 (5.8) | Turkey 429 (4.3) |
| | Missouri 490 (5.3) | |
| | Montgomery County, MD ² 537 (3.5) | |
| | Netherlands † 540 (7.1) | |
| | New Zealand 491 (5.2) | |
| | North Carolina 495 (7.0) | |
| | Oregon 514 (6.0) | |
| | Pennsylvania 507 (6.3) | |
| | Project SMART Consortium, OH 521 (7.5) | |
| | Russian Federation 526 (5.9) | |
| | SOUTHWEST PENNSYLVANIA 517 (7.5) | |
| | Slovak Republic 534 (4.0) | |
| | Slovenia 530 (2.8) | |
| | South Carolina 502 (7.4) | |
| | Texas 516 (9.1) | |
| | United States 502 (4.0) | |

International Average 487 (0.7) ▼

States in italics did not fully satisfy guidelines for sample participation rates (see Appendix A).

† Met guidelines for sample participation rates only after replacement schools were included (see Appendix A).

1 National Desired Population does not cover all of International Desired Population (see Appendix A). Because coverage falls below 65%, Latvia is annotated LSS for Latvian-Speaking Schools only.

2 National Defined Population covers less than 90 percent of National Desired Population (see Appendix A).

‡ Lithuania tested the same cohort of students as other countries, but later in 1999, at the beginning of the next school year.

() Standard errors appear in parentheses. Because results are rounded to the nearest whole number, some totals may appear inconsistent.

SOURCE: IEA Third International Mathematics and Science Study (TIMSS) 1998–1999

| Average Significantly Higher Than SW PA Average ▲ | Average Not Significantly Different From SW PA Average ○ | Average Significantly Lower Than SW PA Average ▼ |
|---|--|--|
| Naperville Sch. Dist. #203, IL 584 (4.1) | Academy School Dist. #20, CO 559 (2.1) | Chicago Public Schools, IL 449 (9.5) |
| | Australia 540 (4.4) | Chile 420 (3.7) |
| | Belgium (Flemish) † 535 (3.1) | Cyprus 460 (2.4) |
| | Bulgaria 518 (5.4) | Delaware Science Coalition, DE 500 (8.4) |
| | Canada 533 (2.1) | Fremont/Lincoln/WestSide PS, NE 511 (5.8) |
| | Chinese Taipei 569 (4.4) | Indonesia 435 (4.5) |
| | Connecticut 529 (10.4) | Iran, Islamic Rep. 448 (3.8) |
| | Czech Republic 539 (4.2) | Israel ² 468 (4.9) |
| | England † 538 (4.8) | Italy 493 (3.9) |
| | Finland 535 (3.5) | Jersey City Public Schools, NJ 440 (9.8) |
| | First in the World Consort., IL 565 (5.3) | Jordan 450 (3.8) |
| | Guilford County, NC ² 534 (7.1) | Latvia (LSS) ¹ 503 (4.8) |
| | Hong Kong, SAR † 530 (3.7) | Lithuania †† 488 (4.1) |
| | Hungary 552 (3.7) | Macedonia, Rep. of 458 (5.2) |
| | Idaho 526 (6.6) | Malaysia 492 (4.4) |
| | Illinois 521 (6.5) | Maryland 506 (7.7) |
| | Indiana † 534 (7.0) | Miami-Dade County PS, FL 426 (10.9) |
| | Japan 550 (2.2) | Moldova 459 (4.0) |
| | Korea, Rep. of 549 (2.6) | Morocco 323 (4.3) |
| | Massachusetts 533 (7.4) | New Zealand 510 (4.9) |
| | Michigan 544 (8.6) | North Carolina 508 (6.5) |
| | Michigan Invitational Group, MI 563 (6.2) | Philippines 345 (7.5) |
| | Missouri 523 (6.5) | Rochester City Sch. Dist., NY 452 (7.4) |
| | Montgomery County, MD ² 531 (4.3) | Romania 472 (5.8) |
| | Netherlands † 545 (6.9) | South Africa 243 (7.8) |
| | Oregon 536 (6.1) | South Carolina 511 (6.7) |
| | Pennsylvania 529 (6.5) | Thailand 482 (4.0) |
| | Project SMART Consortium, OH 539 (8.4) | Tunisia 430 (3.4) |
| | Russian Federation 529 (6.4) | Turkey 433 (4.3) |
| | SOUTHWEST PENNSYLVANIA 543 (7.4) | United States 515 (4.6) |
| | Singapore 568 (8.0) | |
| | Slovak Republic 535 (3.3) | |
| | Slovenia 533 (3.2) | |
| | <i>Texas</i> 509 (10.4) | |
| | | International Average 488 (0.7) ▼ |

States in italics did not fully satisfy guidelines for sample participation rates (see Appendix A).

† Met guidelines for sample participation rates only after replacement schools were included (see Appendix A).

1 National Desired Population does not cover all of International Desired Population (see Appendix A). Because coverage falls below 65%, Latvia is annotated LSS for Latvian-Speaking Schools only.

2 National Defined Population covers less than 90 percent of National Desired Population (see Appendix A).

‡ Lithuania tested the same cohort of students as other countries, but later in 1999, at the beginning of the next school year.

() Standard errors appear in parentheses. Because results are rounded to the nearest whole number, some totals may appear inconsistent.

SOURCE: IEA Third International Mathematics and Science Study (TIMSS) 1998–1999

highest-achieving countries and Benchmarking jurisdictions including Belgium (Flemish),³ Chinese Taipei, First in the World, Hong Kong, Japan, Korea, Naperville, and Singapore.

In both mathematics and science, the region's overall performance was clustered with the majority of countries and Benchmarking jurisdictions, including Pennsylvania. Southwest Pennsylvania performed similarly to the U.S. in mathematics and significantly above the U.S. in science, and the region performed significantly above the international average in both mathematics and science.

How Does Achievement Differ Across Mathematics and Science Content Areas?

This section presents results by the major content areas in mathematics and science to provide information about the possible effects of curricular variation on average achievement. Average performance is provided for five content areas in mathematics: fractions and number sense; measurement; data representation, analysis, and probability; geometry; and algebra. In science, six content areas are reported: earth science; life science; physics; chemistry; environmental and resource issues; scientific inquiry and the nature of science. Exhibits 3.3 and 3.5 present a detailed list of topics covered within each content area for mathematics and science, respectively.

As delineated by the curriculum of the countries around the world and in the Benchmarking entities, mathematics and science contains a range of content areas. For example, almost all TIMSS 1999 Benchmarking participants reported some elements of arithmetic as well as algebra and

geometry in the eighth-grade mathematics curriculum, and earth science, life science, chemistry, and physics in the science curriculum. Since these content areas can differ in complexity, enter the curriculum at different times, receive varying degrees of emphasis, or even be taught as separate courses, we explore results by the major content areas in both mathematics and science in Exhibits 3.4 and 3.6, respectively.

For both mathematics and science content areas, Southwest Pennsylvania performance is compared to all other TIMSS 1999 countries and Benchmarking jurisdictions. Results are presented alphabetically within bands of statistically significant difference. These exhibits are provided to identify the relative strengths and weaknesses of students in the different content areas as well as the possible effects of curricular variation on average achievement.

In mathematics, the six countries scoring highest in the overall mathematics assessment – Singapore, Korea, Chinese Taipei, Hong Kong, Japan, and Belgium (Flemish) – were also the highest-scoring countries (though not always in the same rank order) in each content area. Correspondingly, the Naperville School District and the First in World Consortium were the highest-scoring Benchmarking entities. All of these countries and jurisdictions scored significantly higher than Southwest Pennsylvania in all content areas with only one exception (First in the World did not significantly outscore Southwest Pennsylvania in geometry).

In contrast to the consistent performance across content areas displayed by the highest-performing entities, performance varied substantially for some middle-performing entities, including

³ Belgium has two separate educational systems, Flemish and French. The Flemish system participated in TIMSS 1999.

Fractions and Number Sense

Whole numbers – including place values, factorization and operations (+, -, x, ÷)

Understanding and representing common fractions

Computations with common fractions

Understanding and representing common fractions

Computations with decimal fractions

Relationships between common and decimal fractions, ordering of fractions

Rounding whole numbers and decimal fractions

Estimating the results of computations

Number lines

Whole number powers of integers

Computations with percentages and problems involving percentages

Simple computations with negative numbers

Square roots (of perfect squares less than 144), small integer exponents

Prime factors, highest common factor, lowest common multiple, rules for divisibility

Sets, subsets, union, intersection, Venn diagrams

Rate problems

Concepts of ratio and proportion; ratio and proportion problems

Measurement

Units of measurement; standard metric units

Reading measurement instruments

Estimates of measurement; accuracy of measurement

Conversions of units between measurement systems

Perimeter and area of simple shapes – triangles, rectangles and circles

Perimeter and area of combined shapes

Volume of rectangular solids – i.e.,
volume = length x width x height

Volume of other solids (e.g., pyramids, cylinders, cones, spheres)

Computing with measurements (+, -, x, ÷)

Scales applied to maps and models

Data Representation, Analysis, and Probability

Collecting and graphing data from a survey

Representation and interpretation of data in graphs, charts, and tables

Arithmetic mean

Median and mode

Simple probabilities – understanding and calculations

Geometry

Cartesian coordinates of points in a plane

Coordinates of points on a given straight line

Simple two dimensional geometry – angles on a straight line, parallel lines, triangles and quadrilaterals

Congruence and similarity

Angles – (acute, right, supplementary, etc.)

Pythagorean theorem (without proof)

Symmetry and transformations (reflection and rotation)

Visualization of three-dimensional shapes

Geometric constructions with straight-edge and compass

Regular polygons and their properties – names (e.g., hexagon and octagon), sum of angles, etc.

Proofs (formal deductive demonstrations of geometric relationships)

Sine, cosine, and tangent in right-angle triangles

Nets of solids

Algebra

Number patterns and simple relations

Writing expressions for general terms in number pattern sequence

Translating from verbal descriptions to symbolic expressions

Simple algebraic expressions

Evaluating simple algebraic expressions by substitution of given value of variables

Representing situations algebraically; formulas

Solving simple equations

Solving simple inequalities

Solving simultaneous equations in two variables

Interpreting linear relations

Using the graph of a relationship to interpolate/extrapolate

Fractions and Number Sense

| | | |
|---|--|-----------|
| ▲ | Belgium (Flemish) † | 557 (3.1) |
| | Chinese Taipei | 576 (4.2) |
| | First in the World Consort., IL | 561 (4.9) |
| | Hong Kong, SAR † | 579 (4.5) |
| | Japan | 570 (2.6) |
| | Korea, Rep. of | 570 (2.7) |
| | Naperville Sch. Dist. #203, IL | 569 (3.9) |
| | Singapore | 608 (5.6) |

| | | |
|---|--|-----------|
| ○ | Academy School Dist. #20, CO | 534 (2.8) |
| | Australia | 519 (4.3) |
| | Bulgaria | 503 (6.6) |
| | Canada | 533 (2.5) |
| | Connecticut | 522 (7.9) |
| | Czech Republic | 507 (4.8) |
| | Finland | 531 (3.8) |
| | Fremont/Lincoln/WestSide PS, NE | 498 (6.4) |
| | Guilford County, NC ² | 513 (7.3) |
| | Hungary | 526 (4.2) |
| | Idaho | 505 (6.9) |
| | Illinois | 516 (6.2) |
| | Indiana † | 526 (7.6) |
| | Malaysia | 532 (4.7) |
| | Maryland | 501 (5.9) |
| | Massachusetts | 521 (5.9) |
| | Michigan | 525 (7.2) |
| | Michigan Invitational Group, MI | 535 (5.1) |
| | Montgomery County, MD ² | 540 (5.1) |
| | Netherlands † | 545 (7.1) |
| | North Carolina | 497 (7.0) |
| | Oregon | 521 (6.2) |
| | Pennsylvania | 517 (5.3) |
| | Project SMART Consortium, OH | 527 (7.9) |
| | Russian Federation | 513 (6.4) |
| | SOUTHWEST PENNSYLVANIA | 524 (6.6) |
| | Slovak Republic | 525 (4.8) |
| | Slovenia | 527 (3.7) |
| | South Carolina | 509 (7.0) |
| | Texas | 527 (8.9) |
| | United States | 509 (4.2) |

| | | |
|---|--------------------------------|-----------|
| ▼ | Chicago Public Schools, IL | 474 (6.1) |
| | Chile | 403 (4.9) |
| | Cyprus | 481 (3.0) |
| | Delaware Science Coalition, DE | 487 (8.3) |
| | England † | 497 (3.8) |
| | Indonesia | 406 (4.1) |
| | Iran, Islamic Rep. | 437 (4.5) |
| | Israel ² | 472 (4.4) |
| | Italy | 471 (5.0) |
| | Jersey City Public Schools, NJ | 483 (7.3) |
| | Jordan | 432 (3.2) |
| | Latvia (LSS) † | 496 (3.7) |
| | Lithuania †† | 479 (4.3) |
| | Macedonia, Rep. of | 437 (4.7) |
| | Miami-Dade County PS, FL | 434 (9.0) |
| | Missouri | 497 (4.8) |
| | Moldova | 465 (4.2) |
| | Morocco | 335 (3.6) |
| | New Zealand | 493 (5.0) |
| | Philippines | 378 (6.3) |
| | Rochester City Sch. Dist., NY | 458 (5.7) |
| | Romania | 458 (5.7) |
| | South Africa | 300 (6.0) |
| | Thailand | 471 (5.3) |
| | Tunisia | 443 (2.8) |
| | Turkey | 430 (4.3) |

International Average 487 (0.7) ▼

▲ Average Significantly Higher Than SW PA Average

Measurement

| | | |
|---|--|-----------|
| ▲ | Australia | 529 (4.9) |
| | Belgium (Flemish) † | 549 (4.0) |
| | Canada | 521 (2.4) |
| | Chinese Taipei | 566 (3.4) |
| | Czech Republic | 535 (5.0) |
| | First in the World Consort., IL | 535 (5.8) |
| | Hong Kong, SAR † | 567 (5.8) |
| | Hungary | 538 (3.5) |
| | Japan | 558 (2.4) |
| | Korea, Rep. of | 571 (2.8) |
| | Naperville Sch. Dist. #203, IL | 549 (3.4) |
| | Netherlands † | 538 (5.8) |
| | Russian Federation | 527 (6.0) |
| | Singapore | 599 (6.3) |
| | Slovak Republic | 537 (3.3) |
| | Slovenia | 523 (3.7) |

| | | |
|---|--|-----------|
| ○ | Academy School Dist. #20, CO | 507 (3.5) |
| | Bulgaria | 497 (6.6) |
| | Connecticut | 493 (8.3) |
| | Cyprus | 471 (4.0) |
| | England † | 507 (3.8) |
| | Finland | 521 (4.7) |
| | Fremont/Lincoln/WestSide PS, NE | 474 (8.7) |
| | Guilford County, NC ² | 487 (7.1) |
| | Idaho | 482 (8.1) |
| | Illinois | 491 (6.3) |
| | Indiana † | 489 (6.8) |
| | Italy | 501 (5.0) |
| | Latvia (LSS) † | 505 (3.5) |
| | Malaysia | 514 (4.6) |
| | Maryland | 482 (5.9) |
| | Massachusetts | 491 (7.0) |
| | Michigan | 494 (7.4) |
| | Michigan Invitational Group, MI | 516 (5.8) |
| | Missouri | 474 (6.3) |
| | Moldova | 479 (4.9) |
| | Montgomery County, MD ² | 516 (4.3) |
| | New Zealand | 496 (5.3) |
| | North Carolina | 472 (7.5) |
| | Oregon | 500 (6.3) |
| | Pennsylvania | 489 (6.0) |
| | Project SMART Consortium, OH | 498 (7.8) |
| | Romania | 491 (4.9) |
| | SOUTHWEST PENNSYLVANIA | 495 (7.0) |
| | South Carolina | 475 (7.1) |
| | Texas | 489 (9.1) |
| | United States | 482 (3.9) |

| | | |
|---|--------------------------------|-----------|
| ▼ | Chicago Public Schools, IL | 439 (8.1) |
| | Chile | 412 (4.9) |
| | Delaware Science Coalition, DE | 459 (8.7) |
| | Indonesia | 395 (5.1) |
| | Iran, Islamic Rep. | 401 (4.7) |
| | Israel ² | 457 (5.1) |
| | Jersey City Public Schools, NJ | 450 (9.1) |
| | Jordan | 438 (4.4) |
| | Lithuania †† | 467 (4.0) |
| | Macedonia, Rep. of | 451 (5.2) |
| | Miami-Dade County PS, FL | 407 (8.9) |
| | Morocco | 348 (3.5) |
| | Philippines | 355 (6.2) |
| | Rochester City Sch. Dist., NY | 417 (6.2) |
| | South Africa | 329 (4.8) |
| | Thailand | 463 (6.2) |
| | Tunisia | 442 (3.1) |
| | Turkey | 436 (6.5) |

International Average 487 (0.7) ○

○ Average Not Significantly Different From SW PA Average

Data Representation, Analysis, and Probability

| | | |
|---|--|-----------|
| ▲ | Belgium (Flemish) † | 544 (3.8) |
| | Chinese Taipei | 559 (5.1) |
| | First in the World Consort., IL | 558 (7.3) |
| | Hong Kong, SAR † | 547 (5.4) |
| | Japan | 555 (2.3) |
| | Korea, Rep. of | 576 (4.2) |
| | Naperville Sch. Dist. #203, IL | 559 (4.9) |
| | Singapore | 562 (6.2) |

| | | |
|---|--|------------|
| ○ | Academy School Dist. #20, CO | 527 (4.1) |
| | Australia | 522 (6.3) |
| | Bulgaria | 493 (6.1) |
| | Canada | 521 (4.5) |
| | Connecticut | 516 (9.9) |
| | Czech Republic | 513 (5.9) |
| | Delaware Science Coalition, DE | 493 (9.7) |
| | England † | 506 (8.0) |
| | Finland | 525 (3.8) |
| | Fremont/Lincoln/WestSide PS, NE | 496 (10.8) |
| | Guilford County, NC ² | 520 (10.1) |
| | Hungary | 520 (5.9) |
| | Idaho | 501 (7.2) |
| | Illinois | 510 (7.1) |
| | Indiana † | 518 (6.3) |
| | Jersey City Public Schools, NJ | 488 (9.6) |
| | Latvia (LSS) † | 495 (4.8) |
| | Maryland | 504 (6.4) |
| | Massachusetts | 521 (6.3) |
| | Michigan | 517 (6.8) |
| | Michigan Invitational Group, MI | 538 (6.9) |
| | Missouri | 500 (5.0) |
| | Montgomery County, MD ² | 541 (4.8) |
| | Netherlands † | 538 (7.9) |
| | New Zealand | 497 (5.0) |
| | North Carolina | 502 (5.8) |
| | Oregon | 516 (7.0) |
| | Pennsylvania | 510 (8.6) |
| | Project SMART Consortium, OH | 534 (8.6) |
| | Russian Federation | 501 (4.8) |
| | SOUTHWEST PENNSYLVANIA | 518 (6.5) |
| | Slovak Republic | 521 (4.6) |
| | Slovenia | 530 (4.2) |
| | South Carolina | 507 (7.5) |
| | Texas | 527 (10.2) |
| | United States | 506 (5.2) |

| | | |
|---|-------------------------------|-----------|
| ▼ | Chicago Public Schools, IL | 472 (7.2) |
| | Chile | 429 (3.8) |
| | Cyprus | 472 (4.6) |
| | Indonesia | 423 (4.4) |
| | Iran, Islamic Rep. | 430 (6.0) |
| | Israel ² | 468 (5.1) |
| | Italy | 484 (4.5) |
| | Jordan | 436 (7.8) |
| | Lithuania †† | 493 (3.6) |
| | Macedonia, Rep. of | 442 (6.2) |
| | Malaysia | 491 (4.0) |
| | Miami-Dade County PS, FL | 445 (9.0) |
| | Moldova | 450 (5.7) |
| | Morocco | 383 (3.5) |
| | Philippines | 406 (3.5) |
| | Rochester City Sch. Dist., NY | 465 (6.2) |
| | Romania | 453 (4.7) |
| | South Africa | 356 (3.8) |
| | Thailand | 476 (4.0) |
| | Tunisia | 446 (5.1) |
| | Turkey | 446 (3.3) |

International Average 487 (0.7) ▼

▼ Average Significantly Lower Than SW PA Average

States in italics did not fully satisfy guidelines for sample participation rates (see Appendix A).

† Met guidelines for sample participation rates only after replacement schools were included (see Appendix A).

1 National Desired Population does not cover all of International Desired Population (see Appendix A). Because coverage falls below 65%, Latvia is annotated LSS for Latvian-Speaking Schools only.

2 National Defined Population covers less than 90 percent of National Desired Population (see Appendix A).

‡ Lithuania tested the same cohort of students as other countries, but later in 1999, at the beginning of the next school year.

() Standard errors appear in parentheses. Because results are rounded to the nearest whole number, some totals may appear inconsistent.

Geometry

| | | |
|---|---------------------------------------|-----------|
| ▲ | Belgium (Flemish) † | 535 (4.1) |
| | Bulgaria | 524 (5.9) |
| | Chinese Taipei | 557 (5.8) |
| | Hong Kong, SAR † | 556 (4.9) |
| | Japan | 575 (5.1) |
| | Korea, Rep. of | 573 (3.9) |
| | Latvia (LSS) † | 522 (5.6) |
| | Naperville Sch. Dist. #203, IL | 528 (4.2) |
| | Russian Federation | 522 (6.0) |
| | Singapore | 560 (6.7) |
| | Slovak Republic | 527 (7.3) |

| | | |
|---|--|-----------|
| ○ | Academy School Dist. #20, CO | 499 (5.0) |
| | Australia | 497 (5.7) |
| | Canada | 507 (4.7) |
| | Chicago Public Schools, IL | 457 (6.4) |
| | Connecticut | 470 (7.7) |
| | Cyprus | 484 (4.6) |
| | Czech Republic | 513 (5.5) |
| | Delaware Science Coalition, DE | 457 (6.2) |
| | England † | 471 (4.2) |
| | Finland | 494 (6.0) |
| | First in the World Consortium, IL | 519 (8.6) |
| | Fremont/Lincoln/WestSide PS, NE | 467 (5.6) |
| | Guilford County, NC ² | 491 (7.5) |
| | Hungary | 489 (4.3) |
| | Idaho | 465 (6.5) |
| | Illinois | 483 (6.8) |
| | Indiana † | 476 (7.6) |
| | Israel ² | 462 (5.4) |
| | Italy | 482 (5.6) |
| | Jersey City Public Schools, NJ | 458 (7.6) |
| | Jordan | 449 (7.1) |
| | Lithuania †† | 496 (5.8) |
| | Macedonia, Rep. of | 460 (6.1) |
| | Malaysia | 497 (4.4) |
| | Maryland | 466 (6.0) |
| | Massachusetts | 477 (6.1) |
| | Michigan | 486 (8.0) |
| | Michigan Invitational Group, MI | 495 (8.3) |
| | Missouri | 466 (5.6) |
| | Moldova | 481 (5.0) |
| | Montgomery County, MD ² | 501 (4.5) |
| | Netherlands † | 515 (5.5) |
| | New Zealand | 478 (4.2) |
| | North Carolina | 475 (5.6) |
| | Oregon | 486 (6.8) |
| | Pennsylvania | 473 (4.7) |
| | Project SMART Consortium, OH | 477 (8.1) |
| | Romania | 487 (6.4) |
| | SOUTHWEST PENNSYLVANIA | 482 (8.9) |
| | Slovenia | 506 (6.2) |
| | South Carolina | 476 (7.8) |
| | <i>Texas</i> | 486 (7.9) |
| | Thailand | 484 (4.4) |
| | Tunisia | 484 (4.4) |
| | United States | 473 (4.4) |

| | | |
|---|-------------------------------|-----------|
| ▼ | Chile | 412 (5.4) |
| | Indonesia | 441 (5.1) |
| | Iran, Islamic Rep. | 447 (2.9) |
| | Miami-Dade County PS, FL | 423 (7.8) |
| | Morocco | 407 (2.2) |
| | Philippines | 383 (3.4) |
| | Rochester City Sch. Dist., NY | 433 (6.3) |
| | South Africa | 335 (6.6) |
| | Turkey | 428 (5.7) |

International Average 487 (0.7) ○

▲ Average Significantly Higher Than SW PA Average

Algebra

| | | |
|---|--|-----------|
| ▲ | Chinese Taipei | 586 (4.4) |
| | First in the World Consortium, IL | 561 (5.8) |
| | Hong Kong, SAR † | 569 (4.5) |
| | Japan | 569 (3.3) |
| | Korea, Rep. of | 585 (2.7) |
| | Naperville Sch. Dist. #203, IL | 563 (4.0) |
| | Singapore | 576 (6.2) |

| | | |
|---|--|-----------|
| ○ | Academy School Dist. #20, CO | 532 (3.3) |
| | Australia | 520 (5.1) |
| | Belgium (Flemish) † | 540 (4.6) |
| | Bulgaria | 512 (5.1) |
| | Canada | 525 (2.4) |
| | Connecticut | 513 (8.2) |
| | Czech Republic | 514 (4.0) |
| | Delaware Science Coalition, DE | 497 (8.3) |
| | England † | 498 (4.9) |
| | Finland | 498 (3.1) |
| | Fremont/Lincoln/WestSide PS, NE | 495 (6.9) |
| | Guilford County, NC ² | 524 (6.5) |
| | Hungary | 536 (4.1) |
| | Idaho | 500 (7.3) |
| | Illinois | 513 (5.7) |
| | Indiana † | 515 (6.5) |
| | Jersey City Public Schools, NJ | 496 (7.4) |
| | Latvia (LSS) † | 499 (4.3) |
| | Malaysia | 505 (4.8) |
| | Maryland | 499 (6.4) |
| | Massachusetts | 521 (5.6) |
| | Michigan | 520 (6.0) |
| | Michigan Invitational Group, MI | 533 (7.1) |
| | Missouri | 494 (4.9) |
| | Montgomery County, MD ² | 540 (4.7) |
| | Netherlands † | 522 (7.7) |
| | New Zealand | 497 (4.7) |
| | North Carolina | 510 (6.1) |
| | Oregon | 515 (6.2) |
| | Pennsylvania | 511 (6.1) |
| | Project SMART Consortium, OH | 521 (7.6) |
| | Russian Federation | 529 (4.9) |
| | SOUTHWEST PENNSYLVANIA | 519 (8.5) |
| | Slovak Republic | 525 (4.6) |
| | Slovenia | 525 (2.9) |
| | South Carolina | 511 (6.2) |
| | <i>Texas</i> | 514 (8.5) |
| | United States | 506 (4.1) |

| | | |
|---|-------------------------------|-----------|
| ▼ | Chicago Public Schools, IL | 474 (6.5) |
| | Chile | 399 (4.3) |
| | Cyprus | 479 (1.6) |
| | Indonesia | 424 (5.7) |
| | Iran, Islamic Rep. | 434 (4.9) |
| | Israel ² | 479 (4.5) |
| | Italy | 481 (3.6) |
| | Jordan | 439 (5.3) |
| | Lithuania †† | 487 (3.7) |
| | Macedonia, Rep. of | 465 (4.0) |
| | Miami-Dade County PS, FL | 452 (7.3) |
| | Moldova | 477 (3.7) |
| | Morocco | 353 (4.7) |
| | Philippines | 345 (5.8) |
| | Rochester City Sch. Dist., NY | 466 (7.1) |
| | Romania | 481 (5.2) |
| | South Africa | 293 (7.7) |
| | Thailand | 456 (4.9) |
| | Tunisia | 455 (2.7) |
| | Turkey | 432 (4.6) |

International Average 487 (0.7) ▼

○ Average Not Significantly Different From SW PA Average

▼ Average Significantly Lower Than SW PA Average

Earth Science

Earth's physical features (layers, landforms, bodies of water, rocks, soil)
 Earth's atmosphere (layers, composition, temperature, pressure)
 Earth processes and history (weather and climate, physical cycles, plate tectonics, fossils)
 Earth in the solar system and the universe (interactions between Earth, sun, and moon; relationship to planets and stars)

Biology

Human body - structure and function of organs and systems
 Human bodily processes (metabolism, respiration, digestion)
 Human nutrition, health, and disease
 Biology of plant and animal life (diversity, structure, life processes, life cycles)
 Photosynthesis
 Interactions of living things (biomes and ecosystems, interdependence)
 Reproduction, genetics, evolution, and speciation

Physics

Physical properties and physical changes of matter (weight, mass, states of matter, boiling, freezing)
 Subatomic particles (protons, electrons, neutrons)
 Energy types, sources, and conversions (chemical, kinetic, electric, light energy; work and efficiency)
 Heat and temperature
 Gas laws (relationship between temperature/pressure/volume)
 Wave phenomena, sound, and vibration
 Light (reflection, refraction, light and color)
 Electricity and magnetism (circuits, conductivity, magnets)
 Forces and motion (types of forces, balanced/unbalanced forces, fluid behavior, speed, acceleration)
 Buoyancy

Chemistry

Classification of matter (elements, compounds, solutions, mixtures)
 Structure of matter (atoms, ions, molecules, crystals)
 Formation of solutions (solvents, solutes, soluble/insoluble substances)
 Acids, bases, and salts
 Chemical reactivity and transformations (definition of chemical change, oxidation, combustion)
 Energy and chemical change (exothermic and endothermic reactions, reaction rates)
 Chemical bonding and compound formation (ionic, covalent)
 Chemical equations
 Atomic structure
 Atomic number and atomic mass
 Periodic table
 Valency

Environmental and Resource Issues

Pollution (acid rain, global warming, ozone layer, water pollution)
 Conservation of natural resources (land, water, forests, energy resources)
 Food supply and production, population, and environmental effects of natural and man-made events

Scientific Inquiry and the Nature of Science

Scientific method (formulating hypotheses, making observations, drawing conclusions, generalizing)
 Experimental design (experimental control, materials, and procedures)
 Scientific measurements (reliability, replication, experimental error, accuracy, scales)
 Using scientific apparatus and conducting routine experimental operations
 Gathering, organizing, and representing data (units, tables, charts, graphs)
 Describing and interpreting data

Southwest Pennsylvania, Pennsylvania, and the United States. Southwest Pennsylvania significantly outscored the international average in fractions and number sense, data representation, analysis and probability, and algebra; but scored similarly to the international average in measurement and geometry (Exhibit 3.4).

In science, the countries scoring highest in the overall science assessment – Chinese Taipei, Singapore, Japan, Korea, and the Netherlands – were generally also the highest performers in each content area, although with some exceptions and not necessarily in that order. Similarly, the Benchmarking jurisdictions with the highest overall performance – the Naperville School District, the First in the World Consortium, the Michigan Invitational Group, and the Academy School District – were also the highest-scoring jurisdictions in five of the six science content areas (all except scientific inquiry and the nature of science). Southwest Pennsylvania scored well in many science content areas, with no countries or jurisdictions performing significantly above the region in life science or chemistry, and was outscored significantly in earth science, physics, environmental and resource issues, and scientific inquiry and the nature of science by only a few of the highest-achieving countries and jurisdictions. The region performed significantly higher than the international average in all science content areas (Exhibit 3.6).

These relative differences in performance of the same students across mathematics and science overall, as well as across various content areas within mathematics and science, point to the need to examine the complex variables of curriculum and instruction to help better understand these differences.

Earth Science

| | | |
|---|--|-----------|
| ▲ | Hungary | 560 (3.9) |
| ○ | Academy School Dist. #20, CO | 535 (3.9) |
| | Australia | 519 (6.1) |
| | Belgium (Flemish) † | 533 (3.5) |
| | Bulgaria | 520 (5.7) |
| | Canada | 519 (3.7) |
| | Chinese Taipei | 538 (3.0) |
| | Connecticut | 508 (6.5) |
| | Czech Republic | 533 (6.9) |
| | Delaware Science Coalition, DE | 500 (7.2) |
| | England † | 525 (3.9) |
| | Finland | 520 (5.5) |
| | First in the World Consort., IL | 539 (3.8) |
| | Guilford County, NC ‡ | 519 (8.0) |
| | Hong Kong, SAR † | 506 (4.3) |
| | Idaho | 513 (6.6) |
| | Illinois | 505 (7.2) |
| | Indiana † | 515 (6.3) |
| | Italy | 502 (5.9) |
| | Japan | 533 (6.2) |
| | Korea, Rep. of | 532 (2.7) |
| | Massachusetts | 516 (7.6) |
| | Michigan | 526 (7.9) |
| | Michigan Invitational Group, MI | 546 (6.5) |
| | Missouri | 511 (5.8) |
| | Montgomery County, MD ‡ | 518 (5.9) |
| | Naperville Sch. Dist. #203, IL | 554 (5.6) |
| | Netherlands † | 534 (7.2) |
| | New Zealand | 504 (5.8) |
| | North Carolina | 500 (7.0) |
| | Oregon | 528 (6.7) |
| | Pennsylvania | 515 (6.6) |
| | Project SMART Consortium, OH | 531 (7.8) |
| | Russian Federation | 529 (5.1) |
| | SOUTHWEST PENNSYLVANIA | 528 (6.6) |
| | Singapore | 521 (7.3) |
| | Slovak Republic | 537 (4.3) |
| | Slovenia | 541 (4.3) |
| | South Carolina | 514 (6.5) |
| | Texas | 503 (9.4) |
| | United States | 504 (4.2) |
| ▼ | Chicago Public Schools, IL | 456 (4.1) |
| | Chile | 435 (7.0) |
| | Cyprus | 459 (5.4) |
| | Fremont/Lincoln/WestSide PS, NE | 497 (4.6) |
| | Indonesia | 431 (6.4) |
| | Iran, Islamic Rep. | 459 (5.2) |
| | Israel ‡ | 472 (5.2) |
| | Jersey City Public Schools, NJ | 447 (9.3) |
| | Jordan | 446 (3.5) |
| | Latvia (LSS) † | 495 (5.4) |
| | Lithuania †† | 476 (4.4) |
| | Macedonia, Rep. of | 464 (4.2) |
| | Malaysia | 491 (4.2) |
| | Maryland | 495 (6.1) |
| | Miami-Dade County PS, FL | 446 (9.0) |
| | Moldova | 466 (4.2) |
| | Morocco | 363 (3.3) |
| | Philippines | 390 (5.0) |
| | Rochester City Sch. Dist., NY | 461 (5.1) |
| | Romania | 475 (5.5) |
| | South Africa | 348 (4.8) |
| | Thailand | 470 (3.9) |
| | Tunisia | 442 (2.7) |
| | Turkey | 435 (4.6) |

International Average 488 (0.9) ▼

Life Science

| | | |
|---|--|------------|
| ○ | Academy School Dist. #20, CO | 559 (4.6) |
| | Australia | 530 (4.4) |
| | Belgium (Flemish) † | 535 (4.6) |
| | Bulgaria | 514 (6.9) |
| | Canada | 523 (3.8) |
| | Chinese Taipei | 550 (3.3) |
| | Connecticut | 533 (9.6) |
| | Czech Republic | 544 (4.1) |
| | England † | 533 (6.2) |
| | Finland | 520 (4.0) |
| | First in the World Consort., IL | 567 (4.5) |
| | Fremont/Lincoln/WestSide PS, NE | 524 (5.7) |
| | Guilford County, NC ‡ | 532 (7.6) |
| | Hong Kong, SAR † | 516 (5.5) |
| | Hungary | 535 (4.0) |
| | Idaho | 531 (5.7) |
| | Illinois | 525 (6.8) |
| | Indiana † | 539 (8.4) |
| | Japan | 534 (5.4) |
| | Korea, Rep. of | 528 (3.6) |
| | Maryland | 510 (6.8) |
| | Massachusetts | 531 (6.4) |
| | Michigan | 541 (7.6) |
| | Michigan Invitational Group, MI | 558 (7.5) |
| | Missouri | 525 (6.1) |
| | Montgomery County, MD ‡ | 530 (5.0) |
| | Naperville Sch. Dist. #203, IL | 573 (3.4) |
| | Netherlands † | 536 (7.2) |
| | North Carolina | 513 (5.7) |
| | Oregon | 541 (5.6) |
| | Pennsylvania | 530 (7.6) |
| | Project SMART Consortium, OH | 540 (8.3) |
| | Russian Federation | 517 (6.5) |
| | SOUTHWEST PENNSYLVANIA | 544 (8.6) |
| | Singapore | 541 (7.2) |
| | Slovak Republic | 535 (6.2) |
| | Slovenia | 521 (3.9) |
| | South Carolina | 518 (5.7) |
| | Texas | 513 (9.4) |
| | United States | 520 (4.1) |
| ▼ | Chicago Public Schools, IL | 471 (10.8) |
| | Chile | 431 (3.7) |
| | Cyprus | 468 (3.8) |
| | Delaware Science Coalition, DE | 507 (7.5) |
| | Indonesia | 448 (3.6) |
| | Iran, Islamic Rep. | 437 (3.7) |
| | Israel ‡ | 463 (4.0) |
| | Italy | 488 (4.6) |
| | Jersey City Public Schools, NJ | 457 (8.6) |
| | Jordan | 448 (4.1) |
| | Latvia (LSS) † | 509 (3.9) |
| | Lithuania †† | 494 (4.6) |
| | Macedonia, Rep. of | 468 (4.9) |
| | Malaysia | 479 (5.4) |
| | Miami-Dade County PS, FL | 445 (12.7) |
| | Moldova | 477 (3.9) |
| | Morocco | 347 (2.8) |
| | New Zealand | 501 (5.6) |
| | Philippines | 378 (5.7) |
| | Rochester City Sch. Dist., NY | 476 (8.7) |
| | Romania | 475 (6.0) |
| | South Africa | 289 (7.3) |
| | Thailand | 508 (4.5) |
| | Tunisia | 441 (5.0) |
| | Turkey | 444 (4.5) |

International Average 488 (0.7) ▼

Physics

| | | |
|---|--|-----------|
| ▲ | Chinese Taipei | 552 (3.9) |
| | Hungary | 543 (4.3) |
| | Japan | 544 (2.9) |
| | Naperville Sch. Dist. #203, IL | 557 (4.5) |
| | Singapore | 570 (6.7) |
| ○ | Academy School Dist. #20, CO | 533 (5.8) |
| | Australia | 531 (6.3) |
| | Belgium (Flemish) † | 530 (3.5) |
| | Bulgaria | 505 (5.8) |
| | Canada | 521 (3.8) |
| | Connecticut | 508 (8.0) |
| | Czech Republic | 526 (4.2) |
| | Delaware Science Coalition, DE | 484 (7.5) |
| | England † | 528 (4.5) |
| | Finland | 520 (4.4) |
| | First in the World Consort., IL | 538 (5.7) |
| | Fremont/Lincoln/WestSide PS, NE | 490 (5.2) |
| | Guilford County, NC ‡ | 510 (7.5) |
| | Hong Kong, SAR † | 523 (4.9) |
| | Idaho | 507 (7.3) |
| | Illinois | 506 (6.4) |
| | Indiana † | 509 (6.4) |
| | Korea, Rep. of | 544 (5.1) |
| | Latvia (LSS) † | 495 (3.9) |
| | Lithuania †† | 510 (4.3) |
| | Malaysia | 494 (4.1) |
| | Maryland | 487 (7.3) |
| | Massachusetts | 510 (5.8) |
| | Michigan | 524 (6.8) |
| | Michigan Invitational Group, MI | 536 (7.1) |
| | Missouri | 506 (5.6) |
| | Montgomery County, MD ‡ | 514 (4.0) |
| | Netherlands † | 537 (6.5) |
| | New Zealand | 499 (4.7) |
| | North Carolina | 487 (6.7) |
| | Oregon | 513 (6.9) |
| | Pennsylvania | 503 (6.5) |
| | Project SMART Consortium, OH | 516 (7.0) |
| | Russian Federation | 529 (6.3) |
| | SOUTHWEST PENNSYLVANIA | 516 (7.2) |
| | Slovak Republic | 518 (4.1) |
| | Slovenia | 525 (4.4) |
| | South Carolina | 488 (6.8) |
| | Texas | 492 (7.9) |
| | United States | 498 (5.5) |
| ▼ | Chicago Public Schools, IL | 453 (7.6) |
| | Chile | 428 (5.6) |
| | Cyprus | 459 (2.9) |
| | Indonesia | 452 (5.5) |
| | Iran, Islamic Rep. | 445 (5.7) |
| | Israel ‡ | 484 (5.3) |
| | Italy | 480 (4.1) |
| | Jersey City Public Schools, NJ | 451 (8.2) |
| | Jordan | 459 (3.6) |
| | Macedonia, Rep. of | 463 (6.0) |
| | Miami-Dade County PS, FL | 440 (9.5) |
| | Moldova | 457 (5.5) |
| | Morocco | 352 (4.2) |
| | Philippines | 393 (6.3) |
| | Rochester City Sch. Dist., NY | 452 (6.5) |
| | Romania | 465 (6.8) |
| | South Africa | 308 (6.7) |
| | Thailand | 475 (4.2) |
| | Tunisia | 425 (6.3) |
| | Turkey | 441 (4.0) |

International Average 488 (0.9) ▼

▲ Average Significantly Higher Than SW PA Average

○ Average Not Significantly Different From SW PA Average

▼ Average Significantly Lower Than SW PA Average

States in italics did not fully satisfy guidelines for sample participation rates (see Appendix A).

† Met guidelines for sample participation rates only after replacement schools were included (see Appendix A).

1 National Desired Population does not cover all of International Desired Population (see Appendix A). Because coverage falls below 65%, Latvia is annotated LSS for Latvian-Speaking Schools only.

2 National Defined Population covers less than 90 percent of National Desired Population (see Appendix A).

‡ Lithuania tested the same cohort of students as other countries, but later in 1999, at the beginning of the next school year.

() Standard errors appear in parentheses. Because results are rounded to the nearest whole number, some totals may appear inconsistent.

Chemistry

| | |
|--|------------|
| Academy School Dist. #20, CO | 551 (5.8) |
| Australia | 520 (5.0) |
| Bulgaria | 527 (5.7) |
| Canada | 521 (5.4) |
| Chinese Taipei | 563 (4.3) |
| Connecticut | 521 (9.1) |
| Czech Republic | 512 (5.2) |
| England [†] | 524 (5.5) |
| Finland | 535 (4.5) |
| First in the World Consort., IL | 548 (6.6) |
| Fremont/Lincoln/WestSide PS, NE | 513 (6.2) |
| Guilford County, NC ² | 518 (8.6) |
| Hong Kong, SAR [†] | 515 (5.2) |
| Hungary | 548 (4.7) |
| Idaho | 518 (8.0) |
| Illinois | 508 (7.1) |
| Indiana [†] | 524 (7.4) |
| Japan | 530 (3.1) |
| Korea, Rep. of | 523 (3.7) |
| Massachusetts | 522 (7.8) |
| Michigan | 537 (7.2) |
| Michigan Invitational Group, MI | 554 (9.4) |
| Missouri | 513 (7.1) |
| Montgomery County, MD ² | 519 (4.2) |
| Naperville Sch. Dist. #203, IL | 558 (4.5) |
| Netherlands [†] | 515 (6.4) |
| Oregon | 527 (7.0) |
| Pennsylvania | 516 (8.8) |
| Project SMART Consortium, OH | 534 (8.6) |
| Russian Federation | 523 (8.0) |
| SOUTHWEST PENNSYLVANIA | 537 (7.8) |
| Singapore | 545 (8.3) |
| Slovak Republic | 525 (4.9) |
| Slovenia | 509 (5.4) |
| South Carolina | 502 (8.1) |
| Texas | 497 (10.5) |
| United States | 508 (4.8) |
| Belgium (Flemish) [†] | 508 (3.3) |
| Chicago Public Schools, IL | 441 (10.4) |
| Chile | 435 (5.2) |
| Cyprus | 470 (3.4) |
| Delaware Science Coalition, DE | 495 (8.4) |
| Indonesia | 425 (3.9) |
| Iran, Islamic Rep. | 487 (4.1) |
| Israel ² | 479 (4.7) |
| Italy | 493 (4.8) |
| Jersey City Public Schools, NJ | 428 (8.4) |
| Jordan | 483 (5.5) |
| Latvia (LSS) [†] | 490 (3.7) |
| Lithuania ^{††} | 485 (4.6) |
| Macedonia, Rep. of | 481 (6.1) |
| Malaysia | 485 (3.5) |
| Maryland | 498 (6.9) |
| Miami-Dade County PS, FL | 436 (10.5) |
| Moldova | 451 (5.6) |
| Morocco | 372 (4.8) |
| New Zealand | 503 (4.9) |
| North Carolina | 498 (7.8) |
| Philippines | 394 (6.5) |
| Rochester City Sch. Dist., NY | 453 (7.3) |
| Romania | 481 (6.1) |
| South Africa | 350 (4.0) |
| Thailand | 439 (4.3) |
| Tunisia | 439 (3.7) |
| Turkey | 437 (5.0) |

International Average 488 (0.8) ▼

▲ Average Significantly Higher Than SW PA Average

Environmental and Resource Issues

| | |
|--|------------|
| Chinese Taipei | 567 (4.0) |
| Naperville Sch. Dist. #203, IL | 566 (6.9) |
| Singapore | 577 (8.3) |
| Academy School Dist. #20, CO | 540 (5.7) |
| Australia | 530 (6.3) |
| Belgium (Flemish) [†] | 513 (3.5) |
| Canada | 521 (3.5) |
| Connecticut | 515 (7.5) |
| Czech Republic | 516 (5.7) |
| England [†] | 518 (5.8) |
| Finland | 514 (7.1) |
| First in the World Consort., IL | 549 (5.9) |
| Fremont/Lincoln/WestSide PS, NE | 508 (5.2) |
| Guilford County, NC ² | 531 (9.3) |
| Hong Kong, SAR [†] | 518 (4.9) |
| Hungary | 501 (6.6) |
| Idaho | 522 (7.1) |
| Illinois | 513 (6.8) |
| Indiana [†] | 527 (7.1) |
| Japan | 506 (5.5) |
| Korea, Rep. of | 523 (4.5) |
| Malaysia | 502 (4.4) |
| Maryland | 505 (6.4) |
| Massachusetts | 522 (8.1) |
| Michigan | 529 (7.5) |
| Michigan Invitational Group, MI | 550 (8.0) |
| Missouri | 514 (7.2) |
| Montgomery County, MD ² | 517 (6.4) |
| Netherlands [†] | 526 (8.5) |
| New Zealand | 503 (5.2) |
| North Carolina | 505 (7.2) |
| Oregon | 520 (6.5) |
| Pennsylvania | 522 (8.3) |
| Project SMART Consortium, OH | 525 (7.8) |
| SOUTHWEST PENNSYLVANIA | 528 (6.8) |
| Slovak Republic | 512 (4.5) |
| Slovenia | 519 (3.4) |
| South Carolina | 505 (9.1) |
| Texas | 502 (9.6) |
| Thailand | 507 (3.0) |
| United States | 509 (6.4) |
| Bulgaria | 483 (6.4) |
| Chicago Public Schools, IL | 442 (9.8) |
| Chile | 449 (4.8) |
| Cyprus | 475 (4.3) |
| Delaware Science Coalition, DE | 494 (7.3) |
| Indonesia | 489 (4.8) |
| Iran, Islamic Rep. | 470 (5.5) |
| Israel ² | 458 (4.0) |
| Italy | 491 (5.4) |
| Jersey City Public Schools, NJ | 451 (10.1) |
| Jordan | 476 (6.0) |
| Latvia (LSS) [†] | 493 (5.2) |
| Lithuania ^{††} | 458 (5.1) |
| Macedonia, Rep. of | 432 (4.2) |
| Miami-Dade County PS, FL | 426 (11.9) |
| Moldova | 444 (6.2) |
| Morocco | 396 (5.1) |
| Philippines | 391 (7.6) |
| Rochester City Sch. Dist., NY | 438 (9.6) |
| Romania | 473 (6.6) |
| Russian Federation | 495 (6.6) |
| South Africa | 350 (8.5) |
| Tunisia | 462 (5.0) |
| Turkey | 461 (3.6) |

International Average 488 (0.7) ▼

○ Average Not Significantly Different From SW PA Average

Scientific Inquiry and the Nature of Science

| | |
|--|-----------|
| Naperville Sch. Dist. #203, IL | 581 (3.8) |
| Academy School Dist. #20, CO | 541 (5.1) |
| Australia | 535 (4.9) |
| Belgium (Flemish) [†] | 526 (4.9) |
| Canada | 532 (5.1) |
| Chinese Taipei | 540 (4.9) |
| Connecticut | 533 (7.3) |
| Czech Republic | 522 (5.7) |
| England [†] | 538 (5.1) |
| Finland | 528 (4.0) |
| First in the World Consort., IL | 574 (8.8) |
| Fremont/Lincoln/WestSide PS, NE | 511 (8.4) |
| Guilford County, NC ² | 533 (6.8) |
| Hong Kong, SAR [†] | 531 (2.8) |
| Hungary | 526 (5.9) |
| Idaho | 513 (7.1) |
| Illinois | 532 (8.3) |
| Indiana [†] | 527 (5.0) |
| Japan | 543 (2.8) |
| Korea, Rep. of | 545 (7.3) |
| Maryland | 524 (5.4) |
| Massachusetts | 542 (4.7) |
| Michigan | 538 (6.8) |
| Michigan Invitational Group, MI | 545 (5.1) |
| Montgomery County, MD ² | 542 (4.4) |
| Netherlands [†] | 534 (6.5) |
| New Zealand | 521 (6.8) |
| North Carolina | 516 (5.1) |
| Oregon | 525 (6.0) |
| Pennsylvania | 531 (5.4) |
| Project SMART Consortium, OH | 527 (8.7) |
| SOUTHWEST PENNSYLVANIA | 541 (5.9) |
| Singapore | 550 (5.9) |
| South Carolina | 521 (6.7) |
| Texas | 514 (7.6) |
| United States | 522 (4.3) |
| Bulgaria | 479 (5.6) |
| Chicago Public Schools, IL | 491 (8.1) |
| Chile | 441 (4.7) |
| Cyprus | 467 (4.6) |
| Delaware Science Coalition, DE | 501 (7.3) |
| Indonesia | 446 (4.3) |
| Iran, Islamic Rep. | 446 (5.3) |
| Israel ² | 476 (8.3) |
| Italy | 489 (4.6) |
| Jersey City Public Schools, NJ | 492 (9.8) |
| Jordan | 440 (5.5) |
| Latvia (LSS) [†] | 495 (4.7) |
| Lithuania ^{††} | 483 (6.4) |
| Macedonia, Rep. of | 464 (3.6) |
| Malaysia | 488 (4.5) |
| Miami-Dade County PS, FL | 462 (9.4) |
| Missouri | 515 (4.1) |
| Moldova | 471 (3.8) |
| Morocco | 391 (4.2) |
| Philippines | 403 (5.5) |
| Rochester City Sch. Dist., NY | 476 (7.9) |
| Romania | 456 (5.5) |
| Russian Federation | 491 (4.9) |
| Slovak Republic | 507 (3.9) |
| Slovenia | 513 (4.3) |
| South Africa | 329 (6.4) |
| Thailand | 462 (4.2) |
| Tunisia | 451 (3.4) |
| Turkey | 445 (6.3) |

International Average 488 (0.7) ▼

▼ Average Significantly Lower Than SW PA Average

How Does Participants' Performance Compare with International Benchmarks of Mathematics and Science Achievement?

The TIMSS mathematics and science achievement scales summarize student performance on test items designed to measure a wide range of student knowledge and proficiency. In order to provide descriptions of what performance could mean in terms of the mathematics and science that students know and can do, TIMSS identified four points on the scales for use as international benchmarks⁴ or reference points, and conducted an ambitious scale anchoring exercise to describe students' performance at these benchmarks. Please see the "International Benchmarks of Student Achievement" section in appendix A for information on the scale anchoring method and development and interpretation of the benchmark descriptions.

The Top 10% Benchmark is defined at the 90th percentile on the TIMSS achievement scale, taking into account the performance of all students in all countries participating in 1999. It corresponds to a scale score of 616 in both mathematics and science and is the point above which the top 10 percent of students in the TIMSS 1999 assessment scored in each subject. In mathematics, students performing at this level demonstrated that they could organize information, make generalizations, and explain solution strategies in non-routine problem-solving situations. In science, students at this level demonstrated a grasp of some complex and abstract science concepts in earth science, life science, physics, and chemistry, and showed an understanding of the fundamentals of scientific investigation.

⁴ Readers should be careful not to confuse the international benchmarks, which are points on the international mathematics and science achievement scale chosen to describe specific achievement levels, with the benchmarking exercise itself, which is a process by which participants compare their achievement, curriculum, and instructional practices with those of the best in the world.

The Upper Quarter Benchmark is the 75th percentile on the achievement scale. This point, corresponding to a scale score of 555 in mathematics and 558 in science, is the point above which the top 25 percent of students scored. In mathematics, students scoring at this benchmark demonstrated that they could apply their mathematical understanding and knowledge in a wide variety of relatively complex situations involving fractions, decimals, geometric properties, and algebraic expressions. In science, students at this level demonstrated conceptual understanding of some science cycles, systems, and principles.

The Median Benchmark, with a score of 479 in mathematics and 488 in science, corresponds to the 50th percentile, or median. This is the point above which the top half of students scored on the TIMSS 1999 assessment. In mathematics, students performing at this level showed that they could apply basic mathematical knowledge in straightforward situations, such as one-step word problems involving addition and subtraction or computational problems based on basic properties of geometric figures and simple algebraic relationships. In science, students at this benchmark were able to recognize and communicate basic scientific information across a range of topics.

The Lower Quarter Benchmark is the 25th percentile and corresponds to a scale score of 396 in mathematics and 410 in science. This score point is reached by the top 75 percent of students and may be used as a benchmark of performance for lower-achieving students. In mathematics, students scoring at this level typically demonstrated computational facility with whole numbers. In science, students at this benchmark could recognize some basic facts from earth, life, and physical sciences presented in non-technical language.

If student achievement in mathematics or science were distributed alike in every entity, then each entity would be expected to have about 10 percent of its students reaching the Top 10% Benchmark, 25 percent the Upper Quarter Benchmark, 50 percent the Median Benchmark, and 75 percent the Lower Quarter Benchmark. Instead, reflecting the range in achievement, the high-performing entities generally had greater percentages of students reaching each benchmark, and the low-performing entities had lesser percentages.

Performance at the International Benchmarks

In mathematics, the analysis of performance at these benchmarks suggests that three primary factors appeared to differentiate performance at the four levels:

- The mathematical operation required
- The complexity of the numbers or number system
- The nature of the problem situation.

For example, there is evidence that students performing at the lower end of the scale could add, subtract, and multiply whole numbers. In contrast, students performing at the higher end of the scale solved non-routine problems involving relationships among fractions, decimals, and percents; various geometric properties; and algebraic rules.

Similarly in science, the analysis of performance at the benchmarks suggests that six primary factors appeared to differentiate performance at the four levels:

- The depth and breadth of content area knowledge
- The level of understanding and use of technical vocabulary
- The context of the problem (progressing from practical to more abstract)
- The level of scientific investigation skills
- The complexity of diagrams, graphs, tables, and textual information
- The completeness of written responses.

For example, there is evidence that students performing at the lower end of the scale could recognize basic facts from the earth, life, and physical sciences presented in non-technical language and could interpret and use information presented in simple diagrams. In contrast, students performing at the higher end of the scale demonstrated a grasp of more complex and abstract science concepts; applied knowledge to solve problems; interpreted and used information in diagrams, tables and graphs; and could provide written explanations to communicate their scientific knowledge.

To help interpret the achievement results, this section describes eighth-grade mathematics and science achievement at each benchmark and provides exhibits of Southwest Pennsylvania per-

formance in relation to all other participants at the Top 10% and Upper Quarter benchmarks. Additionally, example items are presented for each benchmark to illustrate the types of test questions that students reaching the benchmark were likely to answer correctly, and they represent the types of items used to develop the descriptions of achievement at the benchmarks.

Item Examples and Student Performance

For each of the example test questions, the percentages of correct responses of Southwest Pennsylvania students as well as those from the group of comparator countries and jurisdictions participating in the TIMSS 1999 Benchmarking Study are given. Symbols are used to denote significant difference. The countries and jurisdictions are presented in alphabetical order within each exhibit.

The Math & Science Collaborative is working on a fuller test item compendium of the complete released set of items (over 50 percent of the administered assessment), to allow educators to examine more of the items, the region's performance, as well as a more complete review of items included as part of the benchmarking scale-anchoring effort.

Achievement at the Top 10% Benchmark

Exhibit 3.7 describes performance at the Top 10% Benchmark in mathematics, with performance on an example item presented in Exhibit 3.8. Students reaching this benchmark in mathematics demonstrated the ability to organize information in problem-solving situations and to apply their understanding of mathematical relationships. Further, in mathematics:

- Unlike students performing at lower benchmarks, students reaching the Top 10% Benchmark typically could correctly answer multistep word problems.
- Students reaching the Top 10% Benchmark exhibited an understanding of the properties of similar triangles and the concept of proportionality of corresponding sides.
- The eighth-grade students reaching this benchmark typically were able to apply a generalization to solve a sequence problem and to show or explain how they arrived at their answer by providing a general expression or an equation.

Performance at the Top 10% Benchmark in science is described in Exhibit 3.9, and an example item is shown in Exhibit 3.10. Students reaching this benchmark in science have demonstrated nearly full mastery of the content of the TIMSS 1999 science test, demonstrating a grasp of some complex and abstract concepts, the ability to apply knowledge to solve problems, and an understanding of the fundamentals of scientific investigation. Further, in science:

Summary

.....
 Students can organize information, make generalizations, and explain solution strategies in non-routine problem solving situations. They can organize information and make generalizations to solve problems; apply knowledge of numeric, geometric, and algebraic relationships to solve problems (e.g., among fractions, decimals, and percents; geometric properties; and algebraic rules); and find the equivalent forms of algebraic expressions.

90th Percentile: 616

Students can organize information in problem-solving situations. They can select and organize information from two sources to solve a complex word problem involving decimals and organize information to solve a multi-step word problem involving whole numbers.

Students can correctly order the four basic operations in computing with decimals and fractions. Students use their understanding of fractions and decimals in multi-step problem situations. They can solve a problem involving both addition and subtraction of simple common fractions and a problem involving multiplication and subtraction of decimals. They can solve word problems involving fractions and decimals which require analysis of the verbal relations described. They can order a set of decimal fractions of up to three decimal places and can identify the pair of numbers satisfying given conditions involving ordering integers, decimals, and fractions. They can solve a time-distance-rate problem involving decimals and the conversion of minutes to seconds. They can work with part-whole ratios and can solve word problems to find the percent change.

Students can apply their knowledge of measurement in more complex problem situations. They can solve problems involving area and perimeter of rectangles and area of inscribed triangles. They apply knowledge of properties of squares to solve multi-step word problems and draw a new rectangle based on a given rectangle and express the ratio of their areas. They can relate different units of time and apply their knowledge of the number of milliliters in a liter to solve a word problem. They recognize that precision of measurement is related to the size of the unit of measurement.

Students can use their knowledge of angles – overlapping and measures of angles in quadrilaterals – to solve problems. They can use their knowledge of congruent and similar triangles to solve problems concerning corresponding parts. They can identify the coordinates of a point on a line given the coordinates of two other points on the line and locate a point on a number line given its distance from two other points on the line. They can identify the image of a triangle under a rotation in a plane.

Students can use proportion to find missing values in a table. Students can identify an equivalent form of a linear inequality involving a fraction. Students can recognize properties of number operations represented in symbolic form. They can solve a multi-step word problem in which there are two unknowns.

Given the first several terms in pictorial form, that grow in either one or two dimensions, students can make generalizations to find terms in the sequences (e.g. 51st), and they can explain the process used to find those terms.

SOURCE: IEA Third International Mathematics and Science Study (TIMSS), 1998–1999

Content area: Measurement

Description: Finds the area between two rectangles when one is inside the other and their sides are parallel.

A rectangular garden that is next to a building has a path around the other three sides, as shown.

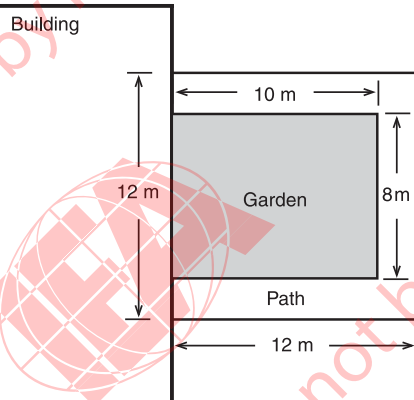

What is the area of the path?

- A. 144 m²
- B. 64 m²
- C. 44 m²
- D. 16 m²

States in italics did not fully satisfy guidelines for sample participation rates (see Appendix A).

† Met guidelines for sample participation rates only after replacement schools were included (see Appendix A).

() Standard errors appear in parentheses.

Percent of Students Responding to the Item Correctly

| | | |
|---------------------------------------|-----------------|----------------------------------|
| International Average | 42 (0.4) | <input type="radio"/> |
| United States | 33 (1.6) | <input type="radio"/> |
| <i>Pennsylvania</i> | 30 (2.8) | <input type="radio"/> |
| Southwest Pennsylvania | 38 (4.1) | |
| Australia | 52 (2.6) | <input type="radio"/> |
| Canada | 51 (3.0) | <input type="radio"/> |
| Chinese Taipei | 73 (2.1) | <input checked="" type="radio"/> |
| Czech Republic | 40 (3.5) | <input type="radio"/> |
| England † | 40 (3.3) | <input type="radio"/> |
| First in the World Consort., IL | 56 (5.9) | <input type="radio"/> |
| Japan | 74 (1.9) | <input checked="" type="radio"/> |
| Korea, Rep. of | 67 (1.7) | <input checked="" type="radio"/> |
| Michigan | 33 (3.3) | <input type="radio"/> |
| Michigan Invitational Group, MI | 41 (4.4) | <input type="radio"/> |
| <i>Naperville Sch. Dist. #203, IL</i> | 69 (4.0) | <input checked="" type="radio"/> |
| Netherlands † | 57 (4.4) | <input type="radio"/> |
| Project SMART Consortium, OH | 39 (5.2) | <input type="radio"/> |
| Singapore | 78 (2.6) | <input checked="" type="radio"/> |

Average Significantly Higher Than SW PA Average

Average Not Significantly Different From SW PA Average

Average Significantly Lower Than SW PA Average

- Students performing at the Top 10% Benchmark could communicate scientific information, such as their understanding of plant growth.
- Students at the Top 10% Benchmark typically were able to apply basic physical principles to solve quantitative problems and support their answers in writing.

- Students reaching this benchmark also demonstrated an understanding of gravitational force.
- At the Top 10% Benchmark, students typically demonstrated knowledge of most of the chemical concepts covered by the TIMSS 1999 science test, including the structure of matter as well as chemical and physical changes.

Summary

Students demonstrate a grasp of some complex and abstract science concepts. They can apply understanding of earth’s formation and cycles and of the complexity of living organisms. They show understanding of the principles of energy efficiency, phase change, thermal expansion, light properties, gravitational force, basic structure of matter, and chemical versus physical changes. They demonstrate detailed knowledge of environmental and resource issues. They understand some fundamentals of scientific investigation and can apply basic physical principles to solve some quantitative problems. They can provide written explanations and use diagrams to communicate scientific knowledge.

90th Percentile: 616

Students can apply knowledge about earth processes such as formation of mountains and underground caves. Given a soil profile diagram, students can identify the layer containing the most organic material. They can diagram all steps in the water cycle, determine the direction of water flow from a contour map, and recognize precipitation patterns from a diagram of elevation and temperature. They also recognize that the seasons are related to the tilt in earth’s axis.

Students show some understanding of the complexity of living organisms. They recognize the hierarchy of organization in living organisms, the definition of tissue, and some animal adaptations needed for survival including physical characteristics and temperature regulation. From a list of organisms, students can identify which one has been on earth for the longest time. They demonstrate understanding of tree growth and of the interrelationships in a food web. In addition, they are able to name a digestive substance found in the human stomach and describe its function.

Students show understanding of physics principles, including efficiency, phase change, thermal expansion, properties of light, and gravitational force. Given data on fuel consumption and work accomplished, students explain which of two machines is more efficient. They also can explain that mass does not change and temperature remains constant during phase change. They can apply knowledge of gas pressure and thermal expansion to explain the effect of heat on the volume of a balloon. They recognize why a red object appears black in green light and explain that a white reflector is more effective than a black one. They also can apply some properties of lenses to human vision and identify the ray diagram depicting light passing through a magnifying glass. Students recognize that gravity acts on a rocket at rest, while ascending, and when returning to earth. They also understand that the surface of a liquid remains horizontal in a tilted container.

Students demonstrate an understanding of the basic structure of matter as well as of chemical and physical changes. They recognize that the nuclei of most atoms are composed of protons and neutrons and that an ion is formed when a neutral atom gains an electron. They can distinguish between chemical and physical changes and recognize that a compound results from the reaction of two elements. They identify oxygen as the gas that causes rust formation and explain why steel beams should be galvanized. Students can distinguish between a pure substance and a mixture, identify a mixture that can be separated by filtration, and recognize that sugar molecules continue to exist when sugar is dissolved in water.

Students show familiarity with environmental and resource issues. They recognize that global warming may lead to rising ocean levels and can explain how acid rain is formed from the burning of fossil fuels. In addition, they can give two reasons why famine occurs.

Students demonstrate understanding of some fundamentals of scientific investigation. They can describe a simple procedure for investigating the effect of exercise on heart rate and recognize the need for repeated measurements.

Students can communicate scientific information. They apply basic physical principles to solve some quantitative problems and develop explanations involving abstract concepts. They can provide answers containing two reasons or consequences and also use diagrams to communicate knowledge.

Content area: Physics

Description: Applies knowledge of gravitational force by recognizing that gravity acts on a rocket at rest, while ascending, and when returning to Earth.

The drawings show a rocket being launched from Earth and then returning.

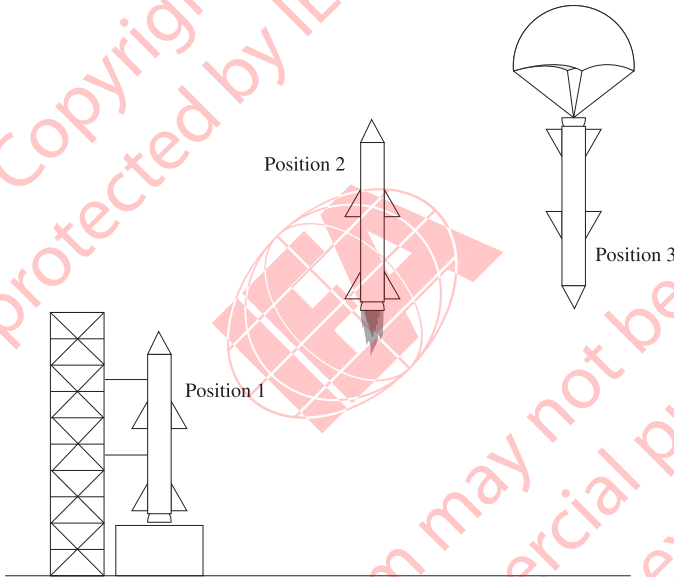

In which of the three positions does gravity act on the rocket?

- A. 3 only
- B. 1 and 2 only
- C. 2 and 3 only
- D. 1, 2 and 3

Percent of Students Responding to the Item Correctly

| | | |
|---------------------------------|-----------------|---|
| International Average | 36 (0.4) | ▼ |
| United States | 46 (2.3) | ○ |
| <i>Pennsylvania</i> | 47 (4.0) | ○ |
| Southwest Pennsylvania | 56 (4.1) | |
| Australia | 45 (2.3) | ○ |
| Canada | 45 (3.3) | ○ |
| Chinese Taipei | 48 (2.3) | ○ |
| Czech Republic | 65 (3.1) | ○ |
| England † | 43 (3.0) | ○ |
| First in the World Consort., IL | 60 (4.7) | ○ |
| Japan | 40 (2.0) | ▼ |
| Korea, Rep. of | 29 (1.7) | ▼ |
| Michigan | 62 (3.4) | ○ |
| Michigan Invitational Group, MI | 65 (4.1) | ○ |
| Naperville Sch. Dist. #203, IL | 64 (4.0) | ○ |
| Netherlands † | 39 (5.3) | ○ |
| Project SMART Consortium, OH | 56 (4.3) | ○ |
| Singapore | 49 (2.8) | ○ |

Average Significantly Higher Than SW PA Average ▲

Average Not Significantly Different From SW PA Average ○

Average Significantly Lower Than SW PA Average ▼

States in italics did not fully satisfy guidelines for sample participation rates (see Appendix A).

† Met guidelines for sample participation rates only after replacement schools were included (see Appendix A).

() Standard errors appear in parentheses.

- Students at this benchmark demonstrated some detailed knowledge of environmental and resource issues not seen at the lower benchmarks, such as rising ocean levels as a predicted result of global warming.

At the Top 10% Benchmark in mathematics, Southwest Pennsylvania performed similarly to the majority of TIMSS 1999 countries and Benchmarking jurisdictions, as shown in Exhibit 3.11. Only a few participants had significantly

Exhibit 3.11: Percentages of Students Reaching TIMSS 1999 Top 10% International Benchmark of Mathematics Achievement

TIMSS 1999
Eighth Grade

| Average Significantly Higher Than SW PA Average ▲ | Average Not Significantly Different From SW PA Average ○ | Average Significantly Lower Than SW PA Average ▼ |
|---|--|--|
| Belgium (Flemish) [†] 23 (1.5) | Academy School Dist. #20, CO 12 (0.8) | Chile 1 (0.5) |
| Chinese Taipei 41 (1.7) | Australia 12 (1.8) | Indonesia 2 (0.4) |
| Hong Kong, SAR [†] 33 (2.3) | Bulgaria 11 (2.3) | Iran, Islamic Rep. 1 (0.2) |
| Japan 33 (1.1) | Canada 12 (1.1) | Morocco 0 (0.0) |
| Korea, Rep. of 37 (1.0) | Chicago Public Schools, IL 2 (0.9) | Philippines 0 (0.1) |
| Naperville Sch. Dist. #203, IL 24 (1.7) | Connecticut 11 (2.5) | South Africa 0 (0.2) |
| Singapore 46 (3.5) | Cyprus 3 (0.4) | Tunisia 0 (0.1) |
| | Czech Republic 11 (1.4) | Turkey 1 (0.3) |
| | Delaware Science Coalition, DE 5 (1.8) | |
| | England [†] 7 (0.9) | |
| | Finland 6 (0.9) | |
| | First in the World Consort., IL 22 (3.2) | |
| | Fremont/Lincoln/WestSide PS, NE 6 (2.3) | |
| | Guilford County, NC ² 10 (2.2) | |
| | Hungary 16 (1.2) | |
| | Idaho 5 (1.1) | |
| | Illinois 10 (1.6) | |
| | Indiana [†] 9 (1.9) | |
| | Israel ² 5 (0.6) | |
| | Italy 5 (0.7) | |
| | Jersey City Public Schools, NJ 6 (1.9) | |
| | Jordan 3 (0.5) | |
| | Latvia (LSS) ¹ 7 (0.9) | |
| | Lithuania [‡] 4 (0.7) | |
| | Macedonia, Rep. of 3 (0.4) | |
| | Malaysia 12 (1.4) | |
| | Maryland 8 (1.4) | |
| | Massachusetts 10 (1.6) | |
| | Miami-Dade County PS, FL 2 (0.9) | |
| | Michigan 10 (2.0) | |
| | Michigan Invitational Group, MI 12 (2.4) | |
| | Missouri 4 (0.9) | |
| | Moldova 4 (0.7) | |
| | Montgomery County, MD ² 17 (2.2) | |
| | Netherlands [†] 14 (2.3) | |
| | New Zealand 8 (1.2) | |
| | North Carolina 7 (1.6) | |
| | Oregon 10 (1.8) | |
| | Pennsylvania 9 (1.3) | |
| | Project SMART Consortium, OH 11 (2.9) | |
| | Rochester City Sch. Dist., NY 2 (0.9) | |
| | Romania 5 (1.1) | |
| | Russian Federation 15 (1.8) | |
| | SOUTHWEST PENNSYLVANIA 11 (2.7) | |
| | Slovak Republic 14 (1.4) | |
| | Slovenia 15 (1.2) | |
| | South Carolina 10 (2.0) | |
| | Texas 13 (2.2) | |
| | Thailand 4 (0.8) | |
| | United States 9 (1.0) | |

States in italics did not fully satisfy guidelines for sample participation rates (see Appendix A).

[†] Met guidelines for sample participation rates only after replacement schools were included (see Appendix A).

1 National Desired Population does not cover all of International Desired Population (see Appendix A). Because coverage falls below 65%, Latvia is annotated LSS for Latvian-Speaking Schools only.

2 National Defined Population covers less than 90 percent of National Desired Population (see Appendix A).

[‡] Lithuania tested the same cohort of students as other countries, but later in 1999, at the beginning of the next school year.

() Standard errors appear in parentheses. Because results are rounded to the nearest whole number, some totals may appear inconsistent.

SOURCE: IEA Third International Mathematics and Science Study (TIMSS) 1998–1999

Exhibit 3.12: Percentages of Students Reaching TIMSS 1999 Top 10% International Benchmark of Science Achievement

TIMSS 1999
Eighth Grade

| Average Significantly Higher Than SW PA Average ▲ | Average Not Significantly Different From SW PA Average ○ | Average Significantly Lower Than SW PA Average ▼ |
|---|--|--|
| Naperville Sch. Dist. #203, IL 33 (2.5) | Academy School Dist. #20, CO 23 (1.6) | Chicago Public Schools, IL 3 (1.1) |
| | Australia 19 (1.6) | Chile 1 (0.4) |
| | Belgium (Flemish) † 11 (1.4) | Cyprus 2 (0.5) |
| | Bulgaria 14 (2.1) | Indonesia 1 (0.3) |
| | Canada 14 (0.9) | Iran, Islamic Rep. 2 (0.3) |
| | Chinese Taipei 31 (1.9) | Israel † 7 (0.6) |
| | Connecticut 17 (3.0) | Italy 7 (0.9) |
| | Czech Republic 17 (1.7) | Jersey City Public Schools, NJ 3 (1.5) |
| | Delaware Science Coalition, DE 10 (1.8) | Jordan 4 (0.5) |
| | England † 19 (1.9) | Latvia (LSS) † 7 (1.3) |
| | Finland 14 (1.4) | Lithuania †† 6 (0.9) |
| | First in the World Consort., IL 27 (3.7) | Macedonia, Rep. of 4 (0.5) |
| | Fremont/Lincoln/WestSide PS, NE 11 (1.7) | Malaysia 6 (0.9) |
| | Guilford County, NC † 19 (2.5) | Miami-Dade County PS, FL 4 (1.4) |
| | Hong Kong, SAR † 10 (1.1) | Moldova 4 (0.5) |
| | Hungary 22 (1.4) | Morocco 0 (0.0) |
| | Idaho 13 (1.8) | Philippines 1 (0.3) |
| | Illinois 14 (1.9) | Rochester City Sch. Dist., NY 3 (1.3) |
| | Indiana † 18 (2.5) | Romania 6 (0.8) |
| | Japan 19 (1.1) | South Africa 0 (0.2) |
| | Korea, Rep. of 22 (1.1) | Thailand 3 (0.7) |
| | Maryland 12 (1.3) | Tunisia 0 (0.1) |
| | Massachusetts 17 (2.4) | Turkey 1 (0.2) |
| | Michigan 22 (2.6) | |
| | Michigan Invitational Group, MI 25 (3.1) | |
| | Missouri 14 (2.3) | |
| | Montgomery County, MD † 17 (1.1) | |
| | Netherlands † 16 (2.3) | |
| | New Zealand 12 (1.4) | |
| | North Carolina 11 (1.4) | |
| | Oregon 19 (2.3) | |
| | Pennsylvania 15 (1.5) | |
| | Project SMART Consortium, OH 19 (3.6) | |
| | Russian Federation 17 (2.4) | |
| | SOUTHWEST PENNSYLVANIA 19 (3.1) | |
| | Singapore 32 (3.3) | |
| | Slovak Republic 14 (1.4) | |
| | Slovenia 16 (1.1) | |
| | South Carolina 13 (1.8) | |
| | <i>Texas</i> 15 (2.1) | |
| | United States 15 (1.2) | |

States in italics did not fully satisfy guidelines for sample participation rates (see Appendix A).

† Met guidelines for sample participation rates only after replacement schools were included (see Appendix A).

1 National Desired Population does not cover all of International Desired Population (see Appendix A). Because coverage falls below 65%, Latvia is annotated LSS for Latvian-Speaking Schools only.

2 National Defined Population covers less than 90 percent of National Desired Population (see Appendix A).

‡ Lithuania tested the same cohort of students as other countries, but later in 1999, at the beginning of the next school year.

() Standard errors appear in parentheses. Because results are rounded to the nearest whole number, some totals may appear inconsistent.

SOURCE: IEA Third International Mathematics and Science Study (TIMSS) 1998-1999

more students attaining this benchmark than did the region, notably the high-achieving countries of Belgium (Flemish), Chinese Taipei, Hong Kong, Japan, Korea, and Singapore; and one high-achieving Benchmarking jurisdiction, Naperville School District. Similarly, only a few of the low-performing countries had significantly fewer students achieving at the Top 10% Benchmark. Southwest Pennsylvania had 11 percent of its students achieve this benchmark in mathematics.

Southwest Pennsylvania performance at this benchmark in science was better, with 19 percent of the region's students reaching this benchmark, given in Exhibit 3.12. Southwest Pennsylvania scored similarly to most high-achieving countries and Benchmarking jurisdictions with the exception of Naperville School District, which significantly outperformed Southwest Pennsylvania with 32 percent of its students achieving this highest benchmark.

Achievement at the Upper Quarter Benchmark

Exhibit 3.13 describes performance at the Upper Quarter Benchmark in mathematics, and performance on an example item is shown in Exhibit 3.14. Eighth-grade students performing at this level in mathematics applied their knowledge and understandings in a wide variety of relatively complex problem situations. For example, in mathematics:

- Students reaching the Upper Quarter Benchmark demonstrated facility with fractions in various formats including proportional reasoning.
- Students at this benchmark generally were able to apply knowledge of geometric properties.
- Students reaching this benchmark typically could solve simple linear equations, such as solving for the value of x in a linear equation involving the variable on both sides of the equation.

Performance at the Upper Quarter Benchmark in science is described in Exhibit 3.15, with an example item shown in Exhibit 3.16. Eighth-grade students performing at this level in science demonstrated conceptual understanding of some science cycles, systems, and principles. For example, in science:

- Even though students at the lower benchmarks demonstrated practical knowledge of rusting and burning, only at the Upper Quarter Benchmark did they typically recognize these as chemical reactions.

Summary

Students can apply their understanding and knowledge in a wide variety of relatively complex situations. They can order, relate and compute with fractions and decimals to solve word problems; solve multi-step word problems involving proportions with whole numbers; solve probability problems; use knowledge of geometric properties to solve problems; identify and evaluate algebraic expressions and solve equations with one variable.

75th Percentile: 555

Students demonstrate some facility with fractions and decimals through computation, ordering, rounding, and use in word problems. They can recognize equivalent fractions, add, subtract, multiply and divide fractions with unlike denominators, and correctly order operations. They can identify the smallest decimal from a set of decimals with differing number of places and provide a fraction that is less than a given fraction. They can solve word problems involving multiplication and division of whole numbers and fractions and use pictorial representations of fractions in solving problems. They can identify the fraction of an hour representing a given time interval and identify fractions representing the comparison of part to whole, given each of two parts in a word problem setting.

Students can select the correct rounding of a number involving four decimal places, identify the decimal that is between two decimals given in hundredths, and solve a word problem that involves multiplying a decimal in thousandths by a multiple of a hundred. They can produce an example of a number that would round to a given value. Given a length rounded to the nearest centimeter, they can identify an example of the actual length expressed to one decimal place. Students can identify the ratio expressing a given whole number comparison in a word problem and recognize the effect of adding the same amount to both terms of a ratio. They can estimate products of whole numbers to solve problems. They can solve multi-step word problems involving proportions with whole numbers.

Students demonstrate their understanding of measurement in several settings. They can compare volumes by visualizing and counting cubes. They can calculate the areas of rectangles contained in diagrams of combined shapes. Given the start time and the duration of an event expressed as a fraction of an hour, they can determine the end time. They can estimate the distance between two points on a map, given the scale, and can read unlabeled tick marks on a scale.

Students can use basic properties of triangles, properties of angles on a straight line, and knowledge of symmetry to find the measures of angles. They can identify the angle in a diagram that represents the best estimate of a given measure and recognize that internal angles on a transversal are supplementary. They can visualize the center of a rotation for a two-dimensional figure, the arrangement of faces of a cube when shown its net, and the number of triangles of given dimensions needed to cover a given rectangle. They can identify false statements about congruent triangles and the properties of rectangles.

Students understand elementary concepts of probability, including independent events. They can solve simple problems involving the relationship between successful and unsuccessful outcomes and probabilities. They also recognize that when outcomes are expressed as fractions of a whole, the least likely outcome corresponds to the smallest fraction. They can extrapolate from a graph and determine the number of values on the horizontal axis of a line graph that correspond to a given value on the vertical axis. On a given graph, students can interpolate to find a value between gradations on one axis matching a given value on the other axis.

Students can recognize that multiplication can represent repeated addition. They can identify the algebraic equation corresponding to a verbal description. They can select a simple, multiplicative expression in one variable that is positive for all negative values of the variable. They can substitute numbers for variables to evaluate an expression, and subtract fractions represented algebraically with the same numeric denominator.

Students can solve a linear equation with or without parentheses. They can identify the linear equation that describes the relationship between two variables given in a table of values and select the formula satisfied by the given values of the variables. They can identify the relationship between the first and second terms in a set of ordered pairs.

Given the first several terms of a sequence in pictorial form, growing in either one or two dimensions, they can find specified terms to extend the sequence.

Content area: Fractions and Number Sense
Description: Shades squares in a rectangular grid to represent a given fraction.

Shade in $\frac{3}{8}$ of the unit squares in the grid.

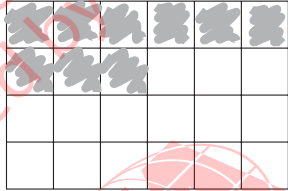

Handwritten student work:
 $8 \overline{)24}$
 $3 \times 3 = 9$

The answer shown illustrates the type of student response that was given credit.

| Percent of Students Responding to the Item Correctly | | |
|--|----------|---|
| International Average | 49 (0.4) | ○ |
| United States | 49 (1.9) | ○ |
| <i>Pennsylvania</i> | 53 (4.0) | ○ |
| Southwest Pennsylvania | 49 (3.7) | |
| Australia | 60 (2.9) | ○ |
| Canada | 68 (2.6) | ● |
| Chinese Taipei | 80 (1.9) | ● |
| Czech Republic | 42 (3.2) | ○ |
| England † | 52 (2.9) | ○ |
| First in the World Consort., IL | 71 (5.6) | ○ |
| Japan | 78 (1.9) | ● |
| Korea, Rep. of | 81 (1.4) | ● |
| Michigan | 54 (3.8) | ○ |
| Michigan Invitational Group, MI | 65 (5.0) | ○ |
| Naperville Sch. Dist. #203, IL | 67 (3.6) | ● |
| Netherlands † | 61 (4.7) | ○ |
| Project SMART Consortium, OH | 51 (5.6) | ○ |
| Singapore | 89 (1.7) | ● |

Average Significantly Higher Than SW PA Average ●
 Average Not Significantly Different From SW PA Average ○
 Average Significantly Lower Than SW PA Average ◐

States in italics did not fully satisfy guidelines for sample participation rates (see Appendix A).

† Met guidelines for sample participation rates only after replacement schools were included (see Appendix A).

() Standard errors appear in parentheses.

- Students performing at the Upper Quarter Benchmark demonstrated basic scientific inquiry skills such as recognizing the variables to be controlled in an experiment and drawing conclusions from a set of observations.

Southwest Pennsylvania performance at the Upper Quarter Benchmark in mathematics, given in Exhibit 3.17, was very similar to the region's performance at the Top 10% Benchmark. While the region surpassed the expected performance at this benchmark with 32 percent of the students attaining this level, Southwest Pennsylvania was

Summary

.....
 Students demonstrate conceptual understanding of some science cycles, systems, and principles. They have some understanding of the earth's processes, biological systems and populations, chemical reactions, and composition of matter. They solve physics problems related to light, speed, heat, and temperature and demonstrate basic knowledge of major environmental concerns. They demonstrate some scientific inquiry skills. They can combine information to draw conclusions; interpret information in diagrams, graphs and tables to solve problems; and provide short explanations conveying scientific knowledge in the life sciences.

75th Percentile: 558

Students have some understanding of earth's processes. They can recognize a definition of sedimentary rock and that fossil fuels are formed from the remains of living things. They demonstrate some understanding of the water cycle and can recognize how a river changes as it flows from a mountain to a plain. Students recognize some features of the solar system, including the definition of an earth year and the relative distances of the Sun and Moon from the earth.

Students show a developing understanding of biological systems and populations. They interpret a diagram depicting the exchange of gases in a forest ecosystem and apply knowledge of energy flow in an ecosystem to complete a food web diagram. In addition, students recognize that the main function of chlorophyll in plants is to absorb light energy and that plants can extract minerals from natural fertilizers. They recognize that preventing sperm production will reduce the insect population and that insects pass on their resistance to insecticides. They also can identify distinguishing features of insects and determine characteristics used to sort animals into classification groups. Students also demonstrate understanding of some elements of the human circulatory and immune systems and are able to describe how the human body temperature is controlled.

Students can solve some basic problems related to light, heat, and temperature. For example, they can relate shadow size to distance from a light source and draw the image of an object reflected in a mirror. Students recognize that metal conducts heat faster than glass, wood, or plastic and why the height of an alcohol column in a thermometer rises with increasing temperature. Students also can determine speed from distance and time and complete a table showing a proportional relation between voltage and current.

Students have some understanding of chemical reactions and the composition of matter. They can identify burning and rusting as chemical reactions, recognize that burning releases energy, and that most of the chemical energy from burning gasoline in a car engine is wasted as heat. Students can explain which candle will be extinguished first based on the amount of oxygen available. They recognize that sugar is a compound composed of molecules made up of atoms and recognize that nothing remains of an object if all of its atoms are removed.

Students demonstrate basic knowledge of major environmental issues. They can explain why the depletion of the ozone layer may be harmful to people, recognize that increased carbon dioxide in the atmosphere may lead to global warming, and can identify coal as a non-renewable resource. Students can state two reasons why some people do not have enough water to drink.

Students demonstrate basic scientific inquiry skills. In an experimental situation, they recognize which variables to control, draw a conclusion from a set of observations, and distinguish an observation from other types of scientific statements.

Students can combine information to draw conclusions; interpret information in diagrams, graphs and tables to solve problems; and provide short explanations conveying scientific knowledge, particularly in the life sciences.

Content area: Life Science

Description: Applies knowledge of energy flow to complete a food web diagram.

An incomplete food web has been drawn for you. Complete it by filling in each of the empty circles with the number of the correct animal or plant from the list. Remember that the arrows represent energy flow and go from the provider to the user.

- 1) Caterpillar
- 2) Corn
- 3) Hawk
- 4) Snake

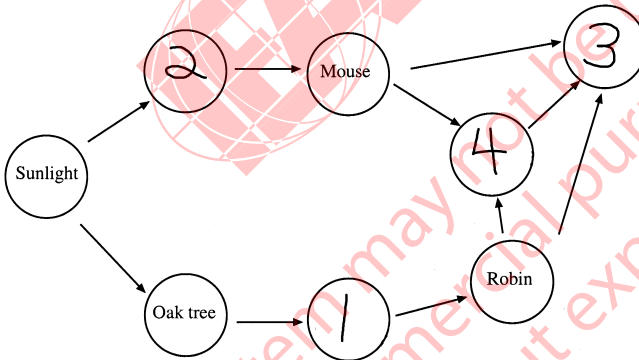

The answer shown illustrates the type of student response that was given credit.

States in italics did not fully satisfy guidelines for sample participation rates (see Appendix A).

† Met guidelines for sample participation rates only after replacement schools were included (see Appendix A).

() Standard errors appear in parentheses.

Percent of Students
Responding to the Item Correctly

| | | |
|---------------------------------|-----------------|---|
| International Average | 55 (0.4) | ○ |
| United States | 56 (1.7) | ○ |
| <i>Pennsylvania</i> | 56 (3.1) | ○ |
| Southwest Pennsylvania | 55 (5.2) | |
| Australia | 60 (2.7) | ○ |
| Canada | 63 (2.7) | ○ |
| Chinese Taipei | 89 (1.4) | ▲ |
| Czech Republic | 60 (2.9) | ○ |
| England † | 75 (2.6) | ▲ |
| First in the World Consort., IL | 64 (5.9) | ○ |
| Japan | 68 (2.0) | ○ |
| Korea, Rep. of | 85 (1.2) | ▲ |
| Michigan | 70 (2.2) | ○ |
| Michigan Invitational Group, MI | 73 (4.2) | ○ |
| Naperville Sch. Dist. #203, IL | 84 (2.6) | ▲ |
| Netherlands † | 58 (3.1) | ○ |
| Project SMART Consortium, OH | 73 (4.1) | ○ |
| Singapore | 89 (1.5) | ▲ |

Average Significantly Higher Than SW PA Average ▲

Average Not Significantly Different From SW PA Average ○

Average Significantly Lower Than SW PA Average ▼

SOURCE: IEA Third International Mathematics and Science Study (TIMSS) 1998–1999

significantly outscored by the high-achieving countries and Benchmarking jurisdictions, where between 54 and 75 percent of students achieved this benchmark.

Southwest Pennsylvania performance at the Upper Quarter Benchmark in science, shown in Exhibit 3.18, also mirrored the region's relative performance at the Top 10% level. With 45 percent of the students achieving at the Upper

Quarter Benchmark, the region scored similarly to or better than all participating countries and jurisdictions with the exception of Naperville, which significantly outperformed the region with 64 percent of its students achieving at this benchmark in science.

Exhibit 3.17: Percentages of Students Reaching TIMSS 1999 Upper Quarter International Benchmark of Mathematics Achievement

TIMSS 1999
Eighth Grade

| Average Significantly Higher Than SW PA Average ▲ | Average Not Significantly Different From SW PA Average ○ | Average Significantly Lower Than SW PA Average ▼ |
|---|--|--|
| Belgium (Flemish) † 54 (1.7) | Academy School Dist. #20, CO 38 (1.5) | Chicago Public Schools, IL 12 (1.7) |
| Chinese Taipei 66 (1.5) | Australia 37 (2.7) | Chile 3 (1.1) |
| First in the World Consort., IL 56 (3.3) | Bulgaria 30 (3.0) | Cyprus 17 (0.8) |
| Hong Kong, SAR † 68 (2.4) | Canada 38 (1.5) | Indonesia 7 (0.9) |
| Japan 64 (0.9) | Connecticut 31 (3.9) | Iran, Islamic Rep. 5 (0.8) |
| Korea, Rep. of 68 (0.9) | Czech Republic 33 (2.1) | Israel ² 18 (1.3) |
| Naperville Sch. Dist. #203, IL 59 (2.2) | Delaware Science Coalition, DE 22 (4.1) | Jordan 11 (0.9) |
| Singapore 75 (2.7) | England † 24 (1.9) | Lithuania †† 17 (2.0) |
| | Finland 31 (1.7) | Macedonia, Rep. of 12 (1.0) |
| | Fremont/Lincoln/WestSide PS, NE 23 (4.1) | Miami-Dade County PS, FL 9 (2.4) |
| | Guilford County, NC ² 33 (3.5) | Moldova 16 (1.5) |
| | Hungary 41 (1.9) | Morocco 0 (0.2) |
| | Idaho 24 (2.9) | Philippines 1 (0.5) |
| | Illinois 29 (2.9) | Rochester City Sch. Dist., NY 9 (2.5) |
| | Indiana † 30 (3.9) | South Africa 1 (0.4) |
| | Italy 20 (1.4) | Thailand 16 (1.8) |
| | Jersey City Public Schools, NJ 17 (3.4) | Tunisia 4 (0.5) |
| | Latvia (LSS) ¹ 26 (1.8) | Turkey 7 (1.0) |
| | Malaysia 34 (2.4) | |
| | Maryland 27 (2.5) | |
| | Massachusetts 31 (2.6) | |
| | Michigan 33 (3.7) | |
| | Michigan Invitational Group, MI 39 (3.4) | |
| | Missouri 20 (2.4) | |
| | Montgomery County, MD ² 45 (1.8) | |
| | Netherlands † 45 (4.1) | |
| | New Zealand 25 (2.4) | |
| | North Carolina 25 (3.1) | |
| | Oregon 32 (2.8) | |
| | Pennsylvania 28 (2.6) | |
| | Project SMART Consortium, OH 34 (4.7) | |
| | Romania 19 (1.9) | |
| | Russian Federation 37 (2.8) | |
| | SOUTHWEST PENNSYLVANIA 32 (3.9) | |
| | Slovak Republic 40 (2.3) | |
| | Slovenia 39 (1.4) | |
| | South Carolina 30 (3.2) | |
| | Texas 37 (3.8) | |
| | United States 28 (1.6) | |

States in italics did not fully satisfy guidelines for sample participation rates (see Appendix A).

- † Met guidelines for sample participation rates only after replacement schools were included (see Appendix A).
- 1 National Desired Population does not cover all of International Desired Population (see Appendix A). Because coverage falls below 65%, Latvia is annotated LSS for Latvian-Speaking Schools only.

2 National Defined Population covers less than 90 percent of National Desired Population (see Appendix A).

- ‡ Lithuania tested the same cohort of students as other countries, but later in 1999, at the beginning of the next school year.
- () Standard errors appear in parentheses. Because results are rounded to the nearest whole number, some totals may appear inconsistent.

SOURCE: IEA Third International Mathematics and Science Study (TIMSS) 1998–1999

Exhibit 3.18: Percentages of Students Reaching TIMSS 1999 Upper Quarter International Benchmark of Science Achievement

TIMSS 1999
Eighth Grade

| Average Significantly Higher Than SW PA Average ▲ | Average Not Significantly Different From SW PA Average ○ | Average Significantly Lower Than SW PA Average ▼ |
|---|--|--|
| Naperville Sch. Dist. #203, IL 64 (2.2) | Academy School Dist. #20, CO 52 (1.5) | Chicago Public Schools, IL 11 (2.4) |
| | Australia 43 (2.3) | Chile 5 (1.0) |
| | Belgium (Flemish) † 39 (1.6) | Cyprus 12 (0.8) |
| | Bulgaria 34 (2.5) | Indonesia 6 (0.9) |
| | Canada 38 (1.3) | Iran, Islamic Rep. 9 (1.0) |
| | Chinese Taipei 58 (2.0) | Israel ² 20 (1.2) |
| | Connecticut 39 (4.4) | Italy 23 (1.7) |
| | Czech Republic 41 (2.2) | Jersey City Public Schools, NJ 11 (3.1) |
| | Delaware Science Coalition, DE 29 (4.0) | Jordan 15 (1.0) |
| | England † 42 (2.3) | Latvia (LSS) ¹ 24 (2.5) |
| | Finland 39 (1.9) | Lithuania †‡ 20 (1.9) |
| | First in the World Consort., IL 54 (3.6) | Macedonia, Rep. of 15 (1.6) |
| | Fremont/Lincoln/WestSide PS, NE 32 (3.1) | Malaysia 21 (1.9) |
| | Guilford County, NC ² 43 (3.6) | Miami-Dade County PS, FL 10 (2.4) |
| | Hong Kong, SAR † 35 (2.1) | Moldova 15 (1.2) |
| | Hungary 49 (1.7) | Morocco 1 (0.2) |
| | Idaho 37 (3.2) | Philippines 3 (0.7) |
| | Illinois 36 (3.0) | Rochester City Sch. Dist., NY 12 (2.5) |
| | Indiana † 41 (3.6) | Romania 19 (1.9) |
| | Japan 48 (1.4) | South Africa 2 (0.6) |
| | Korea, Rep. of 46 (1.2) | Thailand 15 (2.0) |
| | Maryland 31 (3.0) | Tunisia 3 (0.4) |
| | Massachusetts 40 (3.0) | Turkey 6 (0.8) |
| | Michigan 47 (3.6) | |
| | Michigan Invitational Group, MI 54 (3.0) | |
| | Missouri 36 (3.0) | |
| | Montgomery County, MD ² 40 (2.5) | |
| | Netherlands † 46 (3.8) | |
| | New Zealand 32 (2.1) | |
| | North Carolina 30 (2.9) | |
| | Oregon 43 (2.7) | |
| | Pennsylvania 38 (2.5) | |
| | Project SMART Consortium, OH 43 (5.0) | |
| | Russian Federation 38 (2.8) | |
| | SOUTHWEST PENNSYLVANIA 45 (3.6) | |
| | Singapore 56 (3.5) | |
| | Slovak Republic 39 (2.0) | |
| | Slovenia 39 (1.7) | |
| | South Carolina 34 (2.7) | |
| | <i>Texas</i> 35 (3.6) | |
| | United States 34 (1.9) | |

States in italics did not fully satisfy guidelines for sample participation rates (see Appendix A).

† Met guidelines for sample participation rates only after replacement schools were included (see Appendix A).

1 National Desired Population does not cover all of International Desired Population (see Appendix A). Because coverage falls below 65%, Latvia is annotated LSS for Latvian-Speaking Schools only.

2 National Defined Population covers less than 90 percent of National Desired Population (see Appendix A).

‡ Lithuania tested the same cohort of students as other countries, but later in 1999, at the beginning of the next school year.

() Standard errors appear in parentheses. Because results are rounded to the nearest whole number, some totals may appear inconsistent.

SOURCE: IEA Third International Mathematics and Science Study (TIMSS) 1998–1999

Achievement at the Median Benchmark

For the Median and Lower Quarter benchmarks, descriptions of the benchmarks and example items (with performance) are provided; however, since the vast majority of students across most TIMSS 1999 countries and Benchmarking jurisdictions achieved at or above these benchmarks, exhibits of performance across all participants are less useful.

Students at the Median Benchmark in mathematics demonstrated the ability to apply basic knowledge in straightforward situations. Exhibit 3.19 describes this benchmark in mathematics, and Exhibit 3.20 provides performance on a sample benchmark item. In mathematics:

- Students reaching the Median Benchmark showed that they understand rounding and can use it to estimate the results of computations.
- Middle-performing students demonstrated greater competence with word problems than did those at the Lower Quarter Benchmark.
- In geometry, students at the Median Benchmark were able to locate a point on a grid with five-unit divisions that lies between the grid lines.
- Students' at this level demonstrated an emerging familiarity with algebraic representation.

In science, students at this benchmark could recognize and communicate basic scientific knowledge across a range of topics. Exhibit 3.21 describes this benchmark in science more fully, and an example item with performance data is provided in Exhibit 3.22. In science:

- Students reaching the Median Benchmark extracted relevant information from a data table of planetary conditions to describe why a condition would be hostile to human life.
- Students at this benchmark typically demonstrated some knowledge of the characteristics of animals and plants.
- Students typically were familiar with some aspects of force and motion.
- Students at this level were able to apply basic knowledge of the role of oxygen or air in rusting and burning.
- Students showed some elementary knowledge of the human impact on the environment.

Summary

.....
 Students can apply basic mathematical knowledge in straightforward situations. They can add or subtract to solve one-step word problems involving whole numbers and decimals; identify representations of common fractions and relative sizes of fractions; solve for missing terms in proportions; recognize basic notions of percents and probability; use basic properties of geometric figures; read and interpret graphs, tables, and scales; and understand simple algebraic relationships.

50th Percentile: 479

Students can apply basic mathematical knowledge in straightforward situations. They are able to use addition and subtraction to solve one-step word problems involving whole numbers and decimals. They can round whole numbers to the nearest hundred and identify the number sentence that gives the best estimate for the product of two numbers after rounding. Students can arrange four given digits in descending and ascending order to form the largest and smallest possible numbers, and find the difference between those two numbers. Students can approximate the quantity remaining after an amount is reduced by a given percent.

Students demonstrate an understanding of place value in decimal numbers. They can estimate the location of a point representing a decimal number in tenths on a number line marked in whole numbers and identify an unlabeled midway point on a number line marked in tenths. They can set up and solve one-step problems involving addition and subtraction of numbers having up to three decimal places, including situations where the numbers have a different number of decimal places. Given an object of one length, to one decimal place, they can estimate the length of another object.

Students can select the smallest fraction from a list of fractions and can recognize models representing fractions as shaded regions. They can find the missing term in a proportion in word problems and number sentences. Students can solve a simple word problem involving the likelihood of a successful outcome.

Students are able to select the appropriate metric unit to measure the mass of an object. They recognize the inverse relationship between the length of a unit and the number of units required to cover a distance.

Students can locate and interpret data presented in bar graphs, pictographs, pie graphs, and line graphs. Given a table of values for two variables, they can select the graph that represents the given data.

Students can solve problems involving the properties of congruent figures and can select a pair of similar triangles from a set of triangles. They can visualize a rotation of a three-dimensional figure made of cubes. They can locate points in the first quadrant of the Cartesian plane.

Students can select an expression to represent a situation involving multiplication, and identify a linear equation corresponding to a verbal statement. They can find a missing value in a table of values relating x and y values. Using the properties of a balance, they can reason to find an unknown weight. Given diagrams representing the first few terms of a sequence, growing in one dimension, and a partially completed table, they can find the next two terms.

SOURCE: IEA Third International Mathematics and Science Study (TIMSS) 1998–1999

Content area: Algebra

Description: Identifies the linear equation corresponding to a given verbal statement involving a variable.

n is a number. When n is multiplied by 7, and 6 is then added, the result is 41. Which of these equations represents this relation?

A. $7n + 6 = 41$

B. $7n - 6 = 41$

C. $7n \times 6 = 41$

D. $7(n + 6) = 41$

| Percent of Students Responding to the Item Correctly | |
|--|------------|
| International Average | 65 (0.3) ▼ |
| United States | 77 (1.3) ○ |
| <i>Pennsylvania</i> | 81 (1.8) ○ |
| Southwest Pennsylvania | 80 (2.5) |
| Australia | 72 (1.9) ○ |
| Canada | 82 (1.0) ○ |
| Chinese Taipei | 84 (1.1) ○ |
| Czech Republic | 72 (1.7) ○ |
| England † | 62 (2.1) ▼ |
| First in the World Consort., IL | 90 (1.4) ▲ |
| Japan | 86 (0.8) ○ |
| Korea, Rep. of | 85 (0.7) ○ |
| Michigan | 82 (1.6) ○ |
| Michigan Invitational Group, MI | 80 (2.3) ○ |
| Naperville Sch. Dist. #203, IL | 94 (1.4) ▲ |
| Netherlands † | 80 (2.5) ○ |
| Project SMART Consortium, OH | 82 (2.1) ○ |
| Singapore | 89 (1.7) ○ |

▲ Average Significantly Higher Than SW PA Average
 ○ Average Not Significantly Different From SW PA Average
 ▼ Average Significantly Lower Than SW PA Average

States in italics did not fully satisfy guidelines for sample participation rates (see Appendix A).

† Met guidelines for sample participation rates only after replacement schools were included (see Appendix A).

() Standard errors appear in parentheses.

SOURCE: IEA Third International Mathematics and Science Study (TIMSS) 1998–1999

Summary

.....
 Students can recognize and communicate basic scientific knowledge across a range of topics. They recognize some characteristics of the solar system, ecosystems, animals and plants, energy sources, force and motion, light reflection and radiation, sound, electrical circuits, and human impact on the environment. They can apply and briefly communicate practical knowledge, extract tabular information, extrapolate from data presented in a simple linear graph, and interpret representational diagrams.

50th Percentile: 488

Students demonstrate some familiarity with the solar system. They can identify a planetary condition that would be hostile to human life and explain the effect of relative distance on the apparent size of the planets. Students also recognize that the Sun is the source of energy for earth’s water cycle. In addition, they can select the best description of how long the plates making up the earth’s surface have been moving.

Students have a basic understanding of ecosystems. They can describe one role of the Sun in ecosystems and can suggest a negative consequence of the introduction of a new species. They have some knowledge of the characteristics of animals and plants. They recognize that mammals feed milk to their young, wolves use their scent to mark their territories, and that seedlings growing in a forest have large leaves to gather light for photosynthesis. They also can identify some functions of blood.

In physics, students are acquainted with some aspects of energy and motion. They recognize examples of fossil fuels, that a compressed spring has stored energy, and that a given sequence of energy changes applies to gasoline burning to power a car. They recognize that an object will move in a straight line when released from a circular path. They can apply practical knowledge of levers to identify the best way to balance two objects of unequal weight and can identify forces resulting in rotation. Students demonstrate some knowledge of light reflection and radiation. They can identify the apparent position of a reflected image in a mirror, recognize that ultraviolet radiation from the sun causes sunburn and that a person feels cooler wearing light-colored clothes because they reflect more radiation. Students also recognize that sound needs to travel through some medium. They can identify a substance based on whether it is attracted to a magnet and apply knowledge of conductors to identify a complete electrical circuit.

In chemistry, students can apply basic knowledge about the role of air in rusting and burning. They recognize that painting iron prevents exposure to oxygen and moisture and that candles burning in closed containers will be extinguished due to a lack of air.

Students demonstrate elementary knowledge of human impact on the environment. They recognize that soil erosion is more likely in barren sloping areas and in areas subject to overgrazing. Students describe a positive effect on farming of a dam located upriver. Also, they provide one reason for the occurrence of famine.

Students can extract information from a table to draw conclusions and interpret representational diagrams. They also can extrapolate from data presented in a simple linear graph. Students can apply knowledge to practical situations and communicate their practical knowledge through brief descriptive responses.

SOURCE: IEA Third International Mathematics and Science Study (TIMSS) 1998–1999

Content area: Earth Science

Description: Extracts information from a table of planetary conditions to describe a condition hostile to human life.

Diana and Mario were discussing what it might be like on other planets. Their science teacher gave them data about Earth and an imaginary planet Proto. The table shows these data.

| | Earth | Proto |
|---|--|--|
| Distance from a star like the Sun | 148 640 000 km | 902 546 000 km |
| Atmospheric pressure at surface of planet | 101 325 Pa | 100 Pa |
| Atmospheric conditions | | |
| • gas components | 21% oxygen 0.03% carbon dioxide 78% nitrogen | 5% oxygen 5% carbon dioxide 90% nitrogen |
| • ozone layer | yes | no |
| • cloud cover | yes | no |

Write down one important reason why it would be difficult for humans to live on Proto if it existed. Explain your answer.

It would be near impossible to breath on Proto because there is too little oxygen in the atmosphere.

The answer shown illustrates the type of student response that was given credit.

Percent of Students Responding to the Item Correctly

| | | |
|---------------------------------|-----------------|---|
| International Average | 66 (0.4) | ▼ |
| United States | 78 (1.6) | ○ |
| <i>Pennsylvania</i> | 82 (2.2) | ○ |
| Southwest Pennsylvania | 85 (4.1) | |
| Australia | 83 (2.0) | ○ |
| Canada | 82 (2.4) | ○ |
| Chinese Taipei | 79 (1.5) | ○ |
| Czech Republic | 75 (3.0) | ○ |
| England † | 82 (2.4) | ○ |
| First in the World Consort., IL | 91 (3.4) | ○ |
| Japan | 69 (1.7) | ▼ |
| Korea, Rep. of | 77 (1.5) | ○ |
| Michigan | 80 (2.9) | ○ |
| Michigan Invitational Group, MI | 87 (3.4) | ○ |
| Naperville Sch. Dist. #203, IL | 80 (4.0) | ○ |
| Netherlands † | 81 (2.6) | ○ |
| Project SMART Consortium, OH | 80 (3.5) | ○ |
| Singapore | 86 (1.7) | ○ |

Average Significantly Higher Than SW PA Average ●

Average Not Significantly Different From SW PA Average ○

Average Significantly Lower Than SW PA Average ▼

States in italics did not fully satisfy guidelines for sample participation rates (see Appendix A).

† Met guidelines for sample participation rates only after replacement schools were included (see Appendix A).

() Standard errors appear in parentheses.

Achievement at the Lower Quarter Benchmark

Exhibit 3.23 describes performance at the Lower Quarter Benchmark in mathematics, with an example item shown in Exhibit 3.24. Students reaching this level in mathematics typically could demonstrate knowledge of some basic mathematical operations. For example:

- Students reaching the Lower Quarter Benchmark could add, subtract, and round with whole numbers.
- Students generally could subtract one three-decimal-place number from another with multiple regrouping.
- Students at this level could subtract one four-digit integer from another involving multiple regrouping with zeroes.
- Students at this level could read a thermometer and locate the correct reading in a table.

Performance at the Lower Quarter Benchmark in science is described in Exhibit 3.25, and an example item is provided in Exhibit 3.26. Students reaching this level in science could recognize some basic science facts presented using non-technical language. For example:

- Students reaching the Lower Quarter Benchmark typically could demonstrate knowledge of some basic facts about the earth's physical features and could use information presented in simple diagrams.

- Students at this level showed some basic knowledge of human biology, such as recognizing that exercise causes an increase in their breathing and pulse rates.
- Students could recognize some facts about familiar physical phenomena. For example, they demonstrated basic knowledge of light reflection by recognizing that white surfaces reflect more light than colored surfaces.
- Students could recognize that there is greater evaporation from a larger surface area.

Summary

Students can do basic computations with whole numbers.

25th Percentile: 396

The few items at this level provide some evidence that students can add, subtract, and round with whole numbers. When there are the same number of decimal places, they can subtract with multiple regrouping. Students can round whole numbers to the nearest hundred. They can read a thermometer and locate the reading in a table. Students recognize some basic notation.

Exhibit 3.24: Lower Quarter TIMSS International Benchmark of Mathematics Achievement – Example Item 7

| Content area: Fractions and Number Sense | Percent of Students Responding to the Item Correctly |
|---|--|
| Description: Subtracts a four-digit number from another involving zeroes. | International Average 74 (0.4) ○ |
| <p>Subtract:</p> $\begin{array}{r} 7003 \\ - 4078 \\ \hline \end{array}$ <p>A. 2035</p> <p>B. 2925</p> <p>C. 3005</p> <p>D. 3925</p> | United States 81 (1.6) ○ |
| | <i>Pennsylvania</i> 77 (2.4) ○ |
| | Southwest Pennsylvania 79 (2.9) |
| | Australia 77 (2.5) ○ |
| | Canada 83 (1.4) ○ |
| | Chinese Taipei 90 (1.2) ● |
| | Czech Republic 82 (2.4) ○ |
| | England † 51 (3.1) ▼ |
| | First in the World Consort., IL 74 (4.0) ○ |
| | Japan 86 (1.4) ○ |
| | Korea, Rep. of 88 (1.2) ○ |
| | Michigan 73 (3.2) ○ |
| | Michigan Invitational Group, MI 78 (4.8) ○ |
| | <i>Naperville Sch. Dist. #203, IL</i> 88 (2.7) ○ |
| | Netherlands † 79 (3.4) ○ |
| Project SMART Consortium, OH 76 (4.0) ○ | |
| Singapore 92 (1.3) ● | |

States in italics did not fully satisfy guidelines for sample participation rates (see Appendix A).

† Met guidelines for sample participation rates only after replacement schools were included (see Appendix A).

() Standard errors appear in parentheses.

- Average Significantly Higher Than SW PA Average ●
- Average Not Significantly Different From SW PA Average ○
- Average Significantly Lower Than SW PA Average ▼

SOURCE: IEA Third International Mathematics and Science Study (TIMSS) 1998–1999

Summary

.....
 Students recognize some basic facts from the earth, life, and physical sciences presented using non-technical language. They can identify some of the earth’s physical features, have some knowledge of the human body, and demonstrate familiarity with everyday physical phenomena. They can interpret and use information presented in simple diagrams.

25th Percentile: 410

Students know a few basic facts about the earth’s physical features and solar system. For example, they can select the hottest of earth’s layers, recognize that there is less oxygen at higher altitudes and know that the moon reflects sunlight.

Students demonstrate some basic knowledge of human biology and plant features. They recognize that nerves carry sensory messages to the brain, that traits are inherited from both parents and transferred through sperm and egg, that exercise leads to increased breathing and pulse rates, and that vitamins are necessary for human nutrition. They also recognize that seeds develop from flowers of a plant and can state one role of trees in a rainforest.

Students recognize some facts about familiar physical phenomena. They can recognize the correct arrangement of flashlight batteries, the container where evaporation would be greatest, and that fanning a fire makes it burn faster by supplying more oxygen. Students also know some basic facts about light reflection. They can identify the path of light reflected from a mirror, recognize that objects are visible because of reflected light and that white surfaces reflect more light than colored surfaces. They also recognize that a powder made up of both black and white specks is likely to be a mixture.

Students can interpret uncomplicated pictorial diagrams.

Content area: Physics

Description: Recognizes the relationship between surface area and evaporation rate.

A student put 100 mL of water in each of the open containers and let them stand in the sun for one day. Which container would probably lose the most water due to evaporation?

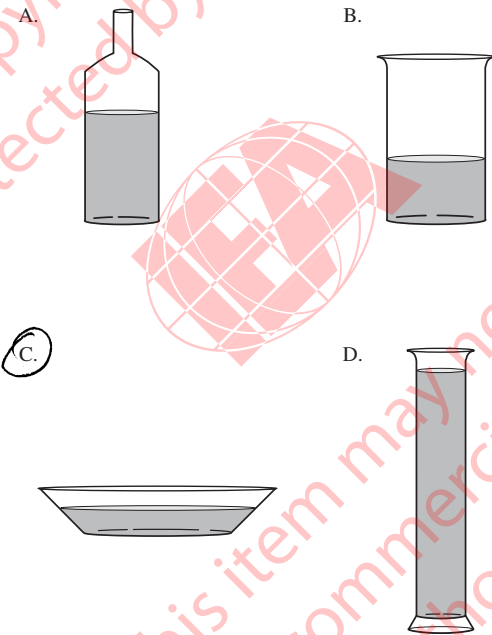

States in italics did not fully satisfy guidelines for sample participation rates (see Appendix A).

† Met guidelines for sample participation rates only after replacement schools were included (see Appendix A).

() Standard errors appear in parentheses.

Percent of Students Responding to the Item Correctly

| | | |
|---------------------------------|----------|----------------------------------|
| International Average | 84 (0.3) | <input type="radio"/> |
| United States | 84 (1.3) | <input type="radio"/> |
| <i>Pennsylvania</i> | 86 (2.1) | <input type="radio"/> |
| Southwest Pennsylvania | 90 (2.2) | |
| Australia | 90 (1.8) | <input type="radio"/> |
| Canada | 91 (1.2) | <input type="radio"/> |
| Chinese Taipei | 93 (0.9) | <input type="radio"/> |
| Czech Republic | 94 (1.6) | <input type="radio"/> |
| England † | 92 (1.7) | <input type="radio"/> |
| First in the World Consort., IL | 95 (2.0) | <input type="radio"/> |
| Japan | 94 (1.2) | <input type="radio"/> |
| Korea, Rep. of | 95 (0.8) | <input type="radio"/> |
| Michigan | 91 (1.7) | <input type="radio"/> |
| Michigan Invitational Group, MI | 89 (2.5) | <input type="radio"/> |
| Naperville Sch. Dist. #203, IL | 92 (2.0) | <input type="radio"/> |
| Netherlands † | 89 (4.7) | <input type="radio"/> |
| Project SMART Consortium, OH | 92 (2.3) | <input type="radio"/> |
| Singapore | 98 (0.8) | <input checked="" type="radio"/> |

Average Significantly Higher Than SW PA Average

Average Not Significantly Different From SW PA Average

Average Significantly Lower Than SW PA Average

Issues Emerging from the Benchmark Descriptions

The benchmark descriptions and example items strongly suggest a gradation in achievement. In mathematics, this extends from the top-performing students' ability to generalize and solve non-routine or contextualized problems to the lower-performing students being able primarily to use routine, mainly numeric procedures. In science, this extends from the top-performing students' ability to grasp complex and abstract science concepts, apply knowledge to solve problems, and understand the fundamentals of scientific investigation to the lower-performing students' recognition of basic facts and familiarity with everyday physical phenomena.

In mathematics, the fact that even at the Median Benchmark students demonstrate only limited achievement in problem solving beyond straightforward one-step problems may suggest a need to reconsider the role, or priority, of problem solving in mathematics curricula. According to the NCTM's "The Teaching Principle," in effective teaching worthwhile mathematical problems are used to introduce important ideas and engage students' thinking. The TIMSS 1999 Benchmarking results show that higher achievement is related to the emphasis that teachers place on reasoning and problem-solving activities (see chapter 5). This finding is consistent with the video study component of TIMSS conducted in 1995. Analyses of videotapes of mathematics classes revealed that in the typical mathematics lesson in Japan students worked on developing solution procedures to

report to the class that were often expected to be original constructions. In contrast, in the typical U.S. lesson students essentially practiced procedures that had been demonstrated by the teacher.

So too, in science, the fact that even at the Median Benchmark students had only a very limited knowledge of chemical concepts suggests a need to reevaluate the attention paid to chemistry in eighth-grade science curricula. In addition, knowledge of systems and cycles in the life and physical sciences was demonstrated mainly by students scoring at the upper benchmarks, indicating that more emphasis in these areas may be needed. Basic scientific inquiry skills also were more in evidence among students scoring at the upper benchmarks, indicating that science curricula in many countries may not be stressing scientific investigation by grade 8.

Performance at these international benchmarks allows Southwest Pennsylvania to examine the region's performance in mathematics and science more closely and fully than does a comparison with an international average. The benchmarking process in TIMSS 1999 presents a useful description of what eighth-grade students at top levels of performance in mathematics and science know and are able to do.

Gender Differences in Mathematics and Science Achievement

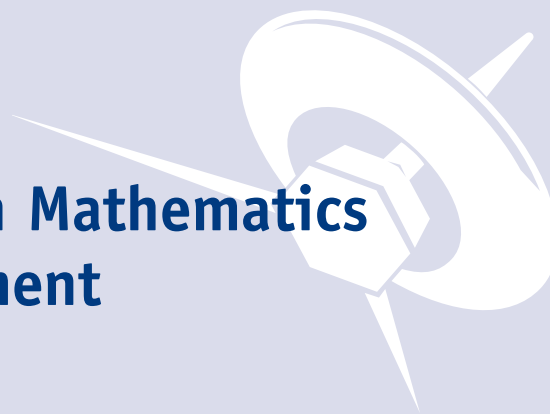

Gender Differences in Mathematics Achievement

It is good news that in mathematics at the eighth grade, the TIMSS 1999 Benchmarking Study shows relatively equivalent average achievement for girls and boys in each of the Benchmarking jurisdictions including Southwest Pennsylvania. The United States as well as a number of other countries around the world appear to be making progress towards gender equity in mathematics education. On average across all TIMSS 1999 countries, there was a modest but significant difference favoring boys, although this varied considerably from country to country. The only countries with differences large enough to be statistically significant were Israel, the Czech Republic, Iran, and Tunisia.⁵

Closer examination of gender differences within content areas in mathematics shows a more well-defined perspective. Exhibit 3.27 explores gender differences in content areas in mathematics, as well as in mathematics overall, for the comparator countries and jurisdictions. Notably, while the region does not show a gender difference in overall mathematics achievement, Southwest Pennsylvania (along with Pennsylvania) does have a gender difference favoring boys in fractions and number sense. Content area differences such as this point toward possible differences in curriculum or instruction that may explain this statistically significant finding.

Although achievement differences between the genders are becoming smaller in mathematics, research indicates that they still exist in those areas involving the most complex mathematical tasks, particularly as students progress to middle and secondary schools.⁶ Thus, Exhibit 3.28 provides information on gender differences in mathematics achievement among students

5 Mullis, I.V.S., Martin, M.O., Gonzalez, E.J., O'Connor, K.M., Chrostowski, S.J., Gregory, K.D., Garden, R.A., and Smith, T.A. (2001), *Mathematics Benchmarking Report, TIMSS 1999 – Eighth Grade: Achievement for U.S. States and Districts in an International Context*, Chestnut Hill, MA: Boston College.

6 Fennema, E. (1996), "Mathematics, Gender, and Research" in G. Hanna (ed.), *Towards Equity in Mathematics Education*, Dordrecht, the Netherlands: Kluwer Academic Publishers.

with high performance compared with those in the middle of the achievement distribution. For each of the comparator entities, score levels were computed for the highest-scoring 25 percent of students, called the upper quarter level, and for the highest-scoring 50 percent, called the median level. The percentages of girls and boys in each entity reaching each of the two levels were computed. For equitable performance, 25 percent each of girls and boys should have reached the upper quarter level, and 50 percent the median level. Data reviewed for the other levels (the highest-scoring 10 percent of students and the highest-scoring 75 percent of students) tend to show the same relationships as those exhibited at the upper quarter and median levels.

On average across countries, 23 percent of girls compared with 27 percent of boys reached the upper quarter level, and 49 percent of girls compared with 51 percent of boys reached the median level. These gender differences, although small, were statistically significant. So too, a statistically significant gender difference favoring boys was apparent in the U.S. and Michigan at the upper quarter level.



| | Average Scale Score | | | | | |
|---------------------------------|---------------------|-------------|----------------------------|-------------|-------------|-------------|
| | Mathematics Overall | | Fractions and Number Sense | | Measurement | |
| | Girls | Boys | Girls | Boys | Girls | Boys |
| International Average | 485 (0.8) | 489 (0.9) ▲ | 484 (0.9) | 491 (0.9) ▲ | 483 (1.0) | 491 (1.0) ▲ |
| United States | 498 (3.9) | 505 (4.8) | 505 (4.5) | 514 (5.0) | 475 (4.0) | 489 (4.9) ▲ |
| <i>Pennsylvania</i> | 503 (6.2) | 512 (7.2) | 510 (5.8) | 524 (5.6) ▲ | 482 (6.0) | 497 (7.4) |
| Southwest Pennsylvania | 509 (7.5) | 525 (8.5) | 517 (6.4) | 531 (7.5) ▲ | 487 (6.9) | 502 (9.0) |
| Australia | 524 (5.7) | 526 (5.7) | 515 (4.7) | 523 (5.7) | 525 (6.4) | 534 (6.5) |
| Canada | 529 (2.5) | 533 (3.2) | 530 (2.4) | 536 (3.4) | 519 (4.6) | 523 (4.4) |
| Chinese Taipei | 583 (3.9) | 587 (5.3) | 574 (4.9) | 579 (5.2) | 563 (3.3) | 569 (5.2) |
| Czech Republic | 512 (4.0) | 528 (5.8) ▲ | 498 (5.7) | 517 (6.1) | 525 (6.1) | 545 (6.6) |
| England † | 487 (5.4) | 505 (5.0) | 487 (6.0) | 507 (5.4) | 500 (6.4) | 515 (5.4) |
| First in the World Consort., IL | 556 (6.7) | 564 (6.8) | 556 (5.5) | 566 (6.3) | 530 (6.7) | 540 (7.8) |
| Japan | 575 (2.4) | 582 (2.3) | 563 (3.4) | 576 (4.0) | 556 (3.5) | 559 (3.0) |
| Korea, Rep. of | 585 (3.1) | 590 (2.2) | 566 (4.3) | 573 (3.3) | 567 (3.8) | 575 (3.2) |
| Michigan | 512 (7.2) | 522 (8.1) | 518 (7.2) | 532 (7.7) | 488 (7.7) | 501 (8.5) |
| Michigan Invitational Group, MI | 535 (5.4) | 529 (7.4) | 538 (5.3) | 533 (5.5) | 512 (7.6) | 520 (8.3) |
| Naperville Sch. Dist. #203, IL | 566 (3.3) | 573 (3.3) | 564 (4.9) | 575 (4.1) | 546 (5.0) | 551 (4.5) |
| Netherlands † | 538 (7.6) | 542 (7.0) | 540 (7.9) | 551 (7.5) | 535 (7.5) | 540 (6.2) |
| Project SMART Consortium, OH | 518 (7.8) | 523 (8.1) | 524 (8.8) | 530 (8.3) | 496 (8.6) | 499 (8.7) |
| Singapore | 603 (6.1) | 606 (7.5) | 607 (6.2) | 609 (6.8) | 597 (7.3) | 601 (9.0) |

▲ Significantly higher than other gender

States in italics did not fully satisfy guidelines for sample participation rates (see Appendix A).

() Standard errors appear in parentheses. Because results are rounded to the nearest whole number, some totals may appear inconsistent.

† Met guidelines for sample participation rates only after replacement schools were included (see Appendix A).

SOURCE: IEA Third International Mathematics and Science Study (TIMSS) 1998–1999

| | Average Scale Score | | | | | |
|---------------------------------|--|------------|-----------|------------|-----------|-----------|
| | Data Representation, Analysis, and Probability | | Geometry | | Algebra | |
| | Girls | Boys | Girls | Boys | Girls | Boys |
| International Average | 486 (1.1) | 489 (1.1) | 485 (1.2) | 489 (1.1) | 489 (0.9) | 485 (0.9) |
| United States | 503 (7.0) | 508 (6.3) | 469 (5.5) | 477 (5.1) | 507 (4.3) | 504 (4.6) |
| <i>Pennsylvania</i> | 508 (9.0) | 513 (11.7) | 466 (5.9) | 479 (5.5) | 512 (7.2) | 510 (7.1) |
| Southwest Pennsylvania | 513 (7.8) | 524 (7.8) | 476 (9.3) | 489 (9.9) | 515 (8.9) | 523 (8.7) |
| Australia | 527 (10.6) | 517 (6.2) | 496 (7.5) | 498 (5.4) | 523 (6.6) | 517 (5.4) |
| Canada | 520 (5.2) | 522 (6.6) | 511 (6.5) | 503 (4.9) | 526 (3.7) | 524 (5.2) |
| Chinese Taipei | 557 (5.5) | 561 (7.9) | 555 (7.1) | 560 (6.8) | 585 (4.5) | 588 (6.1) |
| Czech Republic | 502 (7.0) | 524 (6.9) | 506 (7.6) | 520 (4.9) | 513 (3.9) | 516 (6.7) |
| England † | 498 (6.8) | 513 (10.9) | 467 (4.8) | 474 (6.7) | 493 (6.0) | 502 (5.1) |
| First in the World Consort., IL | 548 (10.3) | 568 (7.4) | 519 (7.2) | 518 (12.5) | 561 (7.6) | 560 (6.3) |
| Japan | 552 (5.5) | 559 (3.8) | 572 (5.8) | 578 (5.8) | 568 (4.2) | 571 (3.6) |
| Korea, Rep. of | 574 (6.2) | 579 (5.4) | 569 (7.3) | 578 (4.8) | 585 (3.7) | 585 (3.9) |
| Michigan | 512 (7.9) | 523 (7.3) | 480 (7.0) | 493 (10.8) | 517 (6.6) | 523 (6.6) |
| Michigan Invitational Group, MI | 547 (10.0) | 530 (6.3) | 500 (8.9) | 489 (10.2) | 540 (6.6) | 525 (8.8) |
| Naperville Sch. Dist. #203, IL | 555 (7.7) | 562 (9.3) | 522 (7.3) | 534 (7.4) | 561 (3.7) | 565 (5.4) |
| Netherlands † | 534 (10.3) | 541 (8.3) | 516 (7.0) | 515 (5.2) | 522 (9.3) | 522 (7.4) |
| Project SMART Consortium, OH | 539 (10.0) | 529 (9.8) | 470 (9.7) | 484 (10.9) | 524 (7.0) | 518 (9.3) |
| Singapore | 563 (6.8) | 561 (8.8) | 556 (9.2) | 565 (6.5) | 578 (6.7) | 574 (7.9) |

† Significantly higher than other gender



Exhibit 3.28: Percentages of Girls and Boys Reaching Each Entity's Own Upper Quarter and Median Levels of Mathematics Achievement

TIMSS 1999
Eighth Grade

| | Upper Quarter | | Median | |
|---------------------------------|------------------|-----------------|------------------|-----------------|
| | Percent of Girls | Percent of Boys | Percent of Girls | Percent of Boys |
| International Average | 23 (0.4) | 27 (0.4) ▲ | 49 (0.4) | 51 (0.4) ▲ |
| United States | 23 (1.3) | 27 (1.9) ▲ | 49 (2.0) | 51 (2.3) |
| <i>Pennsylvania</i> | 22 (3.0) | 28 (2.9) | 48 (3.2) | 52 (3.6) |
| Southwest Pennsylvania | 22 (3.1) | 29 (4.2) | 47 (4.3) | 54 (4.3) |
| Australia | 24 (2.8) | 26 (2.6) | 49 (3.2) | 51 (3.0) |
| Canada | 24 (1.2) | 26 (1.4) | 49 (1.3) | 51 (1.9) |
| Chinese Taipei | 22 (1.5) | 28 (1.9) | 49 (1.9) | 51 (2.1) |
| Czech Republic | 22 (1.6) | 28 (2.5) | 46 (2.4) | 54 (2.9) |
| England † | 20 (2.7) | 30 (2.4) | 46 (3.0) | 54 (2.7) |
| First in the World Consort., IL | 22 (3.8) | 28 (3.7) | 49 (3.6) | 51 (3.9) |
| Japan | 23 (1.3) | 27 (1.1) | 47 (1.5) | 53 (1.3) |
| Korea, Rep. of | 24 (1.1) | 26 (1.0) | 48 (1.5) | 52 (1.3) |
| Michigan | 22 (3.3) | 29 (3.6) ▲ | 48 (4.3) | 52 (3.6) |
| Michigan Invitational Group, MI | 25 (3.6) | 25 (3.6) | 51 (4.2) | 49 (4.5) |
| Naperville Sch. Dist. #203, IL | 23 (1.9) | 27 (2.1) | 49 (2.6) | 51 (2.7) |
| Netherlands † | 24 (3.6) | 26 (3.2) | 48 (4.2) | 52 (4.4) |
| Project SMART Consortium, OH | 24 (4.5) | 26 (4.4) | 49 (4.8) | 51 (5.0) |
| Singapore | 23 (3.1) | 26 (3.4) | 49 (3.6) | 51 (4.2) |

▲ Significantly higher than other gender

States in italics did not fully satisfy guidelines for sample participation rates (see Appendix A).

() Standard errors appear in parentheses. Because results are rounded to the nearest whole number, some totals may appear inconsistent.

† Met guidelines for sample participation rates only after replacement schools were included (see Appendix A).

Gender Differences in Science Achievement

It is disappointing that in science at the eighth grade, the TIMSS 1999 Benchmarking Study shows relatively unequal average achievement for girls and boys in many of the Benchmarking jurisdictions, including Southwest Pennsylvania, in the United States overall, and internationally. Boys had significantly higher average science achievement than girls in 10 of the 13 Benchmarking states including Pennsylvania, with Massachusetts, South Carolina, and Texas the exceptions. Gender differences were less prevalent among the Benchmarking districts and consortia, with significant differences in just four jurisdictions: the First in the World Consortium, Guilford County, Naperville, and Southwest Pennsylvania. On average across all TIMSS 1999 countries, there was a significant difference of 15 scale-score points favoring boys, although this varied considerably from country to country. Differences large enough to be statistically significant were found in 16 of the 38 countries, including the U.S.

Exhibit 3.29 displays average achievement in science content areas, as well in science overall, by gender for the comparator countries and jurisdictions. In the United States this gender difference was evident only in earth science and in Pennsylvania only in chemistry. Among Benchmarking jurisdictions, gender differences were relatively rare, and were found mostly in earth science, physics, and chemistry, a trend that was evident in Southwest Pennsylvania. Again, differences in achievement in content areas may point to curriculum and instruction-related variables to help explain these gender differences.

Exhibit 3.30 shows the percentages of girls and boys reaching each comparator entity's own upper quarter and median levels of science achievement. The gender difference in science favoring boys is more apparent among high-performing students, although internationally it was about the same at both the upper quarter and median levels. In all Benchmarking comparator countries and jurisdictions except the Michigan Invitational Group, Naperville School District, Project SMART, and Singapore, the percentage of boys reaching the upper quarter level was significantly greater than the percentage of girls. This was evident in Southwest Pennsylvania, as well as in Pennsylvania and the United States. There was a significantly greater percentage of boys reaching the median level in Southwest Pennsylvania, Pennsylvania, the U.S., Chinese Taipei, Czech Republic, England, Korea, and Michigan.



| | Average Scale Score | | | | | |
|---------------------------------|---------------------|-------------|---------------|-------------|--------------|-------------|
| | Science Overall | | Earth Science | | Life Science | |
| | Girls | Boys | Girls | Boys | Girls | Boys |
| International Average | 480 (0.9) | 495 (0.9) ▲ | 479 (1.1) | 496 (1.1) ▲ | 487 (1.0) | 488 (1.1) |
| United States | 505 (4.6) | 524 (5.5) ▲ | 490 (5.2) | 518 (5.5) ▲ | 518 (4.4) | 522 (5.0) |
| <i>Pennsylvania</i> | 519 (7.1) | 540 (6.9) ▲ | 508 (8.6) | 524 (11.1) | 526 (8.7) | 535 (8.1) |
| Southwest Pennsylvania | 529 (7.6) | 558 (7.7) ▲ | 516 (6.7) | 542 (7.7) ▲ | 535 (10.0) | 554 (10.9) |
| Australia | 532 (5.1) | 549 (6.0) | 507 (6.0) | 532 (10.9) | 531 (6.1) | 529 (6.1) |
| Canada | 526 (3.2) | 540 (2.4) ▲ | 510 (8.6) | 528 (3.0) | 523 (5.0) | 523 (4.6) |
| Chinese Taipei | 561 (3.9) | 578 (5.7) ▲ | 529 (7.4) | 546 (7.0) | 543 (3.8) | 557 (6.5) |
| Czech Republic | 523 (4.8) | 557 (4.9) ▲ | 513 (8.2) | 554 (9.2) ▲ | 537 (4.8) | 552 (5.7) |
| England † | 522 (6.2) | 554 (5.3) ▲ | 514 (6.2) | 536 (6.4) | 525 (6.9) | 540 (7.2) |
| First in the World Consort., IL | 553 (6.2) | 578 (6.0) ▲ | 531 (6.4) | 546 (6.8) | 556 (5.9) | 578 (5.1) ▲ |
| Japan | 543 (2.8) | 556 (3.6) | 527 (7.9) | 539 (8.0) | 532 (6.4) | 536 (5.7) |
| Korea, Rep. of | 538 (4.0) | 559 (3.2) ▲ | 525 (4.0) | 539 (4.2) | 520 (5.6) | 536 (3.3) |
| Michigan | 533 (8.9) | 556 (8.9) ▲ | 514 (8.5) | 539 (8.4) ▲ | 538 (8.7) | 544 (9.2) |
| Michigan Invitational Group, MI | 555 (6.3) | 572 (7.4) | 539 (7.1) | 554 (8.2) | 557 (8.1) | 559 (9.6) |
| Naperville Sch. Dist. #203, IL | 576 (4.8) | 592 (4.6) ▲ | 551 (8.2) | 558 (7.4) | 568 (5.3) | 579 (4.3) |
| Netherlands † | 536 (7.1) | 554 (7.3) ▲ | 525 (8.5) | 544 (10.2) | 535 (9.6) | 537 (7.8) |
| Project SMART Consortium, OH | 536 (8.9) | 543 (9.0) | 525 (9.6) | 537 (8.7) | 544 (10.4) | 535 (8.9) |
| Singapore | 557 (7.9) | 578 (9.7) | 510 (7.0) | 532 (9.9) | 536 (7.9) | 546 (9.8) |

▲ Significantly higher than other gender

States in italics did not fully satisfy guidelines for sample participation rates (see Appendix A).

() Standard errors appear in parentheses. Because results are rounded to the nearest whole number, some totals may appear inconsistent.

† Met guidelines for sample participation rates only after replacement schools were included (see Appendix A).

SOURCE: IEA Third International Mathematics and Science Study (TIMSS) 1998–1999

| | Average Scale Score | | | | | |
|---------------------------------|---------------------|-------------|------------|--------------|-----------------------------------|-------------|
| | Physics | | Chemistry | | Environmental and Resource Issues | |
| | Girls | Boys | Girls | Boys | Girls | Boys |
| International Average | 477 (1.0) | 498 (1.1) ▲ | 480 (1.1) | 495 (1.1) ▲ | 481 (1.1) | 494 (1.2) ▲ |
| United States | 488 (6.7) | 509 (6.8) | 495 (6.1) | 520 (7.0) | 500 (7.0) | 519 (9.6) |
| <i>Pennsylvania</i> | 490 (7.7) | 516 (9.1) | 503 (8.4) | 530 (10.1) ▲ | 512 (10.6) | 532 (9.5) |
| Southwest Pennsylvania | 500 (8.4) | 532 (9.0) ▲ | 526 (7.9) | 548 (8.8) ▲ | 517 (9.1) | 540 (6.8) |
| Australia | 519 (8.2) | 542 (6.7) | 504 (5.6) | 536 (7.5) ▲ | 521 (7.0) | 540 (9.0) |
| Canada | 512 (4.3) | 530 (4.9) ▲ | 512 (6.3) | 531 (7.4) | 514 (4.8) | 529 (6.0) |
| Chinese Taipei | 542 (6.6) | 563 (6.8) | 555 (4.1) | 571 (8.3) | 555 (6.7) | 579 (4.9) |
| Czech Republic | 510 (6.2) | 544 (6.8) ▲ | 492 (6.7) | 532 (8.8) ▲ | 502 (5.8) | 530 (7.1) ▲ |
| England † | 513 (5.8) | 543 (5.3) ▲ | 503 (6.8) | 543 (6.6) ▲ | 503 (7.5) | 532 (5.6) ▲ |
| First in the World Consort., IL | 522 (6.4) | 553 (7.2) ▲ | 532 (9.2) | 564 (8.1) | 535 (9.9) | 563 (6.2) |
| Japan | 537 (4.6) | 552 (2.7) | 522 (5.0) | 537 (2.7) | 500 (8.6) | 511 (5.9) |
| Korea, Rep. of | 534 (6.5) | 553 (5.7) | 515 (9.1) | 532 (5.5) | 516 (3.0) | 529 (7.5) |
| Michigan | 512 (8.0) | 536 (8.5) | 526 (9.1) | 548 (8.9) | 519 (8.7) | 538 (7.6) |
| Michigan Invitational Group, MI | 524 (6.7) | 549 (10.2) | 543 (10.4) | 565 (10.2) | 536 (8.9) | 564 (13.7) |
| Naperville Sch. Dist. #203, IL | 542 (6.9) | 571 (5.4) ▲ | 553 (6.2) | 564 (5.0) | 558 (6.9) | 575 (11.0) |
| Netherlands † | 524 (6.6) | 550 (7.7) ▲ | 505 (7.3) | 526 (7.5) | 517 (10.4) | 536 (9.0) |
| Project SMART Consortium, OH | 509 (8.3) | 524 (9.5) | 528 (8.5) | 539 (12.3) | 516 (9.1) | 534 (8.9) |
| Singapore | 557 (6.9) | 581 (8.4) | 535 (9.8) | 554 (11.3) | 570 (10.1) | 584 (11.5) |

▲ Significantly higher than other gender



| | Average Scale Score | |
|---------------------------------|---|------------|
| | Scientific Inquiry and the Nature of Science | |
| | Girls | Boys |
| International Average | 489 (1.0) | 486 (1.2) |
| United States | 521 (5.4) | 523 (6.2) |
| <i>Pennsylvania</i> | 536 (6.9) | 527 (5.9) |
| Southwest Pennsylvania | 537 (5.8) | 544 (7.1) |
| Australia | 540 (8.3) | 529 (3.9) |
| Canada | 535 (5.4) | 530 (5.3) |
| Chinese Taipei | 544 (5.3) | 537 (5.4) |
| Czech Republic | 524 (4.9) | 519 (8.9) |
| England † | 536 (5.7) | 540 (8.3) |
| First in the World Consort., IL | 585 (10.3) | 562 (12.6) |
| Japan | 546 (6.3) | 540 (5.9) |
| Korea, Rep. of | 547 (10.1) | 544 (6.5) |
| Michigan | 539 (7.2) | 537 (7.4) |
| Michigan Invitational Group, MI | 552 (6.3) | 538 (6.9) |
| Naperville Sch. Dist. #203, IL | 580 (5.4) | 582 (5.4) |
| Netherlands † | 539 (8.8) | 530 (9.1) |
| Project SMART Consortium, OH | 535 (8.9) | 519 (9.8) |
| Singapore | 552 (6.5) | 548 (6.6) |

† Significantly higher than other gender

Exhibit 3.30: Percentages of Girls and Boys Reaching Each Entity's Own Upper Quarter and Median Levels of Science Achievement

| | Upper Quarter | | Median | |
|---------------------------------|------------------|-----------------|------------------|-----------------|
| | Percent of Girls | Percent of Boys | Percent of Girls | Percent of Boys |
| International Average | 21 (0.3) | 29 (0.4) ▲ | 46 (0.4) | 54 (0.4) ▲ |
| United States | 20 (1.6) | 30 (2.0) ▲ | 46 (2.1) | 54 (2.2) ▲ |
| <i>Pennsylvania</i> | 20 (2.2) | 31 (2.2) ▲ | 45 (4.4) | 56 (3.0) ▲ |
| Southwest Pennsylvania | 18 (2.6) | 32 (3.4) ▲ | 43 (3.6) | 58 (4.2) ▲ |
| Australia | 20 (1.8) | 30 (2.4) ▲ | 46 (2.9) | 55 (3.0) |
| Canada | 21 (1.5) | 29 (1.3) ▲ | 46 (1.7) | 54 (1.7) |
| Chinese Taipei | 20 (1.6) | 30 (2.1) ▲ | 46 (2.0) | 54 (2.4) ▲ |
| Czech Republic | 18 (1.8) | 32 (2.4) ▲ | 42 (2.5) | 58 (2.5) ▲ |
| England † | 19 (2.5) | 31 (2.4) ▲ | 43 (3.0) | 56 (2.3) ▲ |
| First in the World Consort., IL | 18 (3.2) | 33 (2.9) ▲ | 43 (3.4) | 57 (4.2) |
| Japan | 21 (1.3) | 29 (1.4) ▲ | 46 (2.0) | 54 (1.7) |
| Korea, Rep. of | 21 (1.4) | 29 (1.4) ▲ | 44 (1.7) | 55 (1.5) ▲ |
| Michigan | 19 (2.8) | 31 (3.2) ▲ | 44 (3.6) | 56 (3.5) ▲ |
| Michigan Invitational Group, MI | 21 (2.5) | 30 (3.3) | 46 (3.3) | 54 (4.6) |
| Naperville Sch. Dist. #203, IL | 22 (2.8) | 28 (2.6) | 46 (3.3) | 54 (3.0) |
| Netherlands † | 21 (2.5) | 30 (3.4) ▲ | 45 (4.1) | 56 (4.0) |
| Project SMART Consortium, OH | 22 (4.1) | 28 (4.4) | 47 (5.4) | 53 (4.6) |
| Singapore | 20 (2.9) | 30 (4.0) | 45 (3.9) | 55 (4.2) |

▲ Significantly higher than other gender

States in italics did not fully satisfy guidelines for sample participation rates (see Appendix A).

() Standard errors appear in parentheses. Because results are rounded to the nearest whole number, some totals may appear inconsistent.

† Met guidelines for sample participation rates only after replacement schools were included (see Appendix A).



The gender differences found among the Benchmarking jurisdictions are consistent with the results of TIMSS in both 1995 and 1999, which showed a pervasive difference in science achievement favoring boys, far more evident than in mathematics.⁷ They are also consistent with the results from the second IEA science study conducted in 1983-84, which for 14-year-olds found standard score differences favoring boys in all 23 of the participating countries.⁸

The patterns in the performance of girls and boys found in TIMSS 1999 are consistent with previous IEA science assessments. Girls tended to perform about the same as boys in life science in both TIMSS 1995 and the Second International Science Study (SISS),⁹ while boys were markedly stronger in earth science, physics, and chemistry.

Gender differences, especially when more notable at various achievement levels, point to possible curriculum and instructional factors that might explain these achievement differences. The decrease in the gender "achievement gap" in mathematics over a number of years, and a pervasive gender difference in science among the same student population, provide further evidence that educational policies and practices may indeed impact performance.

7 Beaton, A.E., Mullis, I.V.S., Martin, M.O., Gonzalez, E.J., Kelly, D.L., and Smith, T.A. (1996), *Mathematics Achievement in the Middle School Years: The IEA's Third International Mathematics and Science Study (TIMSS)*, Chestnut Hill, MA: Boston College; Mullis, I.V.S., Martin, M.O., Gonzalez, E.J., Gregory, K.D., Garden, R.A., O'Connor, K.M., Chrostowski, S.J., and Smith, T.A. (2000), *TIMSS 1999 International Science Report: Findings from IEA's Repeat of the Third International Mathematics and Science Study at the Eighth Grade*, Chestnut Hill, MA: Boston College.

8 Postlethwaite, T.N. and Wiley, D.E. (1992), *The IEA Study of Science II: Science Achievement in Twenty-Three Countries*, New York, NY: Pergamon Press.

9 Postlethwaite T.N. and Wiley, D.E. (1992), *The IEA Study of Science II: Science Achievement in Twenty-Three Countries*, New York, NY: Pergamon Press; Beaton, A.E., Martin, M.O., Mullis, I.V.S., Gonzalez, E.J., Smith, T.A., and Kelly, D.L. (1996a), *Science Achievement in the Middle School Years: IEA's Third International Mathematics and Science Study (TIMSS)*, Chestnut Hill, MA: Boston College.

Chapter 4

The Mathematics and Science Curriculum



Cynthia A. Tananis, Ed.D.

Steven J. Chrostowski, Ed.M.



In this chapter:

- What Are the Major Characteristics of the Intended Curriculum?
- What Content Do Teachers Emphasize at the Eighth Grade?
- What Can Be Learned About the Curriculum?

A Focus for Continued Exploration

What We Teach and Who We Teach Matters



Chapter 4 presents information about the intended and implemented curriculum in the TIMSS 1999 countries and Benchmarking states, districts, and consortia. The last part of the chapter provides an area of focus on the use of exemplary materials and the issue of “content tracking,” especially in mathematics.

In comparing achievement across systems, it is important to consider differences in students’ curricular experiences and how they may affect the mathematics and science they have studied. At the most fundamental level, students’ opportunity to learn the content, skills, and processes tested in the TIMSS 1999 assessment depends to a great extent on the curricular goals and intentions inherent in each system’s policies for mathematics and science education. Just as important as what students are expected to learn, however, is what their teachers choose to teach them, which ultimately determines the content students are taught.

Teachers’ instructional programs are usually guided by an “official curriculum” that describes the mathematics and science education that should be provided. The official curriculum can be communicated by documents or statements of various sorts (often called guides, guidelines, standards, or frameworks) prepared by the education ministry or by national or regional education departments. In the case of Southwest Pennsylvania, these are the state mathematics and science standards. These documents, together with supporting material such as instructional guides, local curriculum guides, and textbooks, are referred to as the *intended curriculum*.

To collect information about the intended mathematics and science curriculum at the eighth grade, the coordinators in each participating country and Benchmarking jurisdiction responsible for implementing the study completed questionnaires and participated in interviews. Information was gathered about factors related to supporting and monitoring the implementation of the official curriculum, including instructional materials, audits, and assessments aligned with the curriculum. Because Southwest Pennsylvania participated in the Benchmarking Study as a geographic workforce region with a representative sample of schools chosen to administer the test in, it was impossible in some cases to fully describe the diversity of curricula across the region. While a regional summary is not necessarily available, individual districts may still compare their own mathematics and science curricula with data provided by TIMSS countries and Benchmarking jurisdictions.

In many cases, teachers need to interpret and modify the intended curriculum according to their perceptions of the needs and abilities of their classes, and this evolves into the *implemented curriculum*. Research has shown that, even in highly regulated education systems, this is not identical to the intended curriculum. Furthermore, what is actually implemented is often inconsistent across an education system. Studies, including the Second International Mathematics Study, suggest that the implemented curriculum in the United States varies considerably from classroom to classroom – calling for more research into not only what is intended to be taught but what content is covered.¹ To collect data about the implemented curriculum, the mathematics and science teachers

1 Mayer, D.P., Mullens, J.E., and Moore, M.T. (2000), *Monitoring School Quality: An Indicators Report*, NCES 2001-030, Washington, DC: National Center for Education Statistics.

SOURCE: IEA Third International Mathematics and Science Study (TIMSS) 1998–1999

| | Separate Science Courses Offered | Science Subjects and Grades Taught |
|---------------------------------|----------------------------------|---|
| United States | No | General/integrated science course |
| Pennsylvania | Varies | Districts have the ability to decide the structure of their science instruction |
| Southwest Pennsylvania | Varies | Districts have the ability to decide the structure of their science instruction |
| Australia ¹ | No | General/integrated science course |
| Canada ² | No | General sciences organized by strands (grades K-8) |
| Chinese Taipei | Yes | Natural science (1-6); biology (7); integrated physics/chemistry (8); integrated physics/chemistry continues to be taught at grade 9 in addition to earth science |
| Czech Republic | Yes | Elementary science (1-3), General/integrated science (4-5); physics (6-8); chemistry (8); life science/biology (6-8); earth science (6-8) |
| England | No | General/integrated science course, though some schools (especially independent ones) may offer physics, chemistry, and biology, separately |
| First in the World Consort., IL | No | General/integrated science course (K-8) |
| Japan | No | General/integrated science course |
| Korea, Rep. of | No | Intelligent life (combined with social studies) (1-2); science (3-8) |
| Michigan | – | – |
| Michigan Invitational Group, MI | No | General/integrated science course (K-8) |
| Naperville Sch. Dist. #203, IL | No | General science course (K-8) with emphasis on earth science, life science, and physical science |
| Netherlands | Yes | General/integrated science (primary school up to grade 6); physics/chemistry, biology, geography which includes earth science (7-8) |
| Project SMART Consortium, OH | No | General/integrated science course (K-8) |
| Singapore | No | General/integrated science course |

Background data provided by coordinators from participating entities.

1 Australia: Yes in 4 of 8 states/territories.

2 Canada: Results shown are for the majority of provinces.

A dash (–) indicates data are not available.

of the students tested in TIMSS 1999 completed questionnaires about whether students had been taught the various mathematics and science topics covered in the test.

While mathematics in grades eight and lower may emphasize different topics at higher or lower levels, it is almost universally taught as one unified course at each of the primary and middle grades. On the other hand, science in the eighth and earlier grades is taught as separate subjects in some countries and integrated to form a general science course in others. Exhibit 4.1 shows how science instruction is organized in these grades in

the TIMSS 1999 comparator countries and Benchmarking jurisdictions. By the eighth grade, Chinese Taipei and most of the European countries were teaching some or all of earth science, biology, physics, and chemistry as separate subjects, not necessarily contemporaneously.

What Are the Major Characteristics of the Intended Curriculum?

Exhibit 4.2 indicates the relative emphasis given to various aspects of mathematics instruction in the intended curriculum. As might be anticipated for students at this point in their schooling, major emphasis in the comparator countries was most commonly placed on understanding mathematical concepts and mastering basic skills. Assessing student learning was also given major emphasis in most countries. “Real-life” applications of mathematics were stressed in the curriculum of most countries. In the Netherlands, for example, this approach was reported to be emphasized even more heavily than either understanding mathematics concepts or mastering basic skills.

Communicating mathematically, an aspect of teaching and learning that has received increasing attention in recent years, was given major or moderate emphasis in the curriculum of most of the comparator countries. Adopting a multicultural approach, working on mathematics projects, solving non-routine problems, deriving formal proofs, and integrating mathematics with other school subjects all received less emphasis.

In general, curricular emphasis among the Benchmarking participants was very similar to that in the United States as a whole. A majority of the Benchmarking entities placed major emphasis in their curricula on mastering basic skills, understanding mathematics concepts, real-life applications of mathematics, communicating mathematically, and assessing student learning. With only one exception, all the other entities placed moderate emphasis in each of these areas.

Exhibit 4.3 indicates the relative emphasis given to various aspects of science instruction in the intended curriculum. Knowing basic science facts and understanding science concepts received major emphasis in the curriculum of most participating countries, and at least moderate emphasis was placed on application of science concepts in almost all national curricula. In addition to these three areas, the United States reported placing major emphasis on using laboratory equipment, performing experiments, and designing and conducting scientific experiments, as did top-performing Singapore, Korea, and Japan. The Czech Republic’s intended curriculum had minor or no emphasis on any aspect of practical work.

The Benchmarking jurisdictions were similar to the United States overall in the curricular areas that they reported placing major emphasis on. All Benchmarking jurisdictions reported placing major emphasis on understanding science concepts and on applying science concepts, and all jurisdictions except Pennsylvania on designing and conducting scientific experiments. There were also areas of different emphasis. Although the pattern varied quite a lot, relatively less emphasis was reported by Benchmarking states on knowing basic science facts (particularly in Michigan), on using laboratory equipment, and on performing experiments, and relatively more emphasis on assessment. The Benchmarking districts and consortia resembled the United States overall rather more closely, although again there was relatively more emphasis on assessment, as well as on communicating scientific procedures and explanations, reported in almost all of these jurisdictions.

SOURCE: IEA Third International Mathematics and Science Study (TIMSS) 1998–1999

| | Mastering Basic Skills | Understanding Mathematics Concepts | Real-life Applications of Mathematics | Communicating Mathematically | Solving Non-Routine Problems | Deriving Formal Proofs | Working on Mathematics Projects | Integration of Mathematics with Other School Subjects | Thematic Approach | Multicultural Approach | Assessing Student Learning |
|--|------------------------|------------------------------------|---------------------------------------|------------------------------|------------------------------|------------------------|---------------------------------|---|-------------------|------------------------|----------------------------|
| United States | ● | ● | ● | ● | ● | ● | ● | ● | ● | ● | ● |
| Pennsylvania | ● | ● | ● | ● | ● | ● | ● | ● | ● | ● | ● |
| Southwest Pennsylvania ¹ | – | – | – | – | – | – | – | – | – | – | – |
| Australia | ● | ● | ● | ● | ● | ● | ● | ● | ● | ● | ● |
| Canada ² | ● | ● | ● | ● | ● | ● | ● | ● | ● | ● | ● |
| Chinese Taipei | ● | ● | ● | ● | ● | ● | ● | ● | ● | ● | ● |
| Czech Republic | ● | ● | ● | ● | ● | ● | ● | ● | ● | ● | ● |
| England | ● | ● | ● | ● | ● | ● | ● | ● | ● | ● | ● |
| First in the World Consort., IL | ● | ● | ● | ● | ● | ● | ● | ● | ● | ● | ● |
| Japan | ● | ● | ● | ● | ● | ● | ● | ● | ● | ● | ● |
| Korea, Rep. of | ● | ● | ● | ● | ● | ● | ● | ● | ● | ● | ● |
| Michigan | ● | ● | ● | ● | ● | ● | ● | ● | ● | ● | ● |
| Michigan Invitational Group, MI | ● | ● | ● | ● | ● | ● | ● | ● | ● | ● | ● |
| Naperville Sch. Dist. #203, IL | ● | ● | ● | ● | ● | ● | ● | ● | ● | ● | ● |
| Netherlands | ● | ● | ● | ● | ● | ● | ● | ● | ● | ● | ● |
| Project SMART Consortium, OH | ● | ● | ● | ● | ● | ● | ● | ● | ● | ● | ● |
| Singapore | ● | ● | ● | ● | ● | ● | ● | ● | ● | ● | ● |

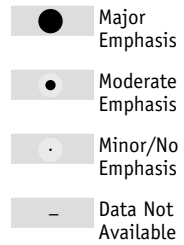

Background data provided by coordinators from participating entities.

2 Canada: Results shown are for the majority of provinces.

1 Southwest Pennsylvania: Covering a workforce region of 118 autonomous districts, a representative response for these questions could not be provided.

It is possible that in some entities some of the approaches and processes reported as being given minor or no emphasis in the intended curriculum may receive more emphasis in the implemented curriculum. Conversely, it is also possible that some of the approaches and processes reported as being given major or moderate emphasis in the intended curriculum may receive less emphasis in the implemented curriculum.

Southwest Pennsylvania was unable to provide summary information for Exhibits 4.2 and 4.3 due to the diversity of curricula represented in the region. Pennsylvania responses were based on what is intended by the state standards as written in 1999.

Exhibit 4.3: Emphasis on Approaches and Processes in Science

SOURCE: IEA Third International Mathematics and Science Study (TIMSS) 1998–1999

| | Knowing Basic Science Facts | Understanding Science Concepts | Applying Science Concepts to Solve Problems and Develop Explanations | Using Laboratory Equipment | Performing Experiments | Designing and Conducting Scientific Investigations | Communicating Scientific Procedures and Explanations in Written and Oral Form | Integration of Science with Mathematics | Science, Technology and Society | Cross-Disciplinary Approach (Integration of the Sciences and Other School Subjects) | Thematic Approach | Multicultural Approach | Assessing Student Learning |
|-------------------------------------|-----------------------------|--------------------------------|--|----------------------------|------------------------|--|---|---|---------------------------------|---|-------------------|------------------------|----------------------------|
| United States | ● | ● | ● | ● | ● | ● | ● | ● | ● | ● | ● | ● | ● |
| Pennsylvania | ● | ● | ● | ● | ● | ● | ● | ● | ● | ● | ● | ● | ● |
| Southwest Pennsylvania ¹ | - | - | - | - | - | - | - | - | - | - | - | - | - |
| Australia | ● | ● | ● | ● | ● | ● | ● | ● | ● | ● | ● | ● | ● |
| Canada ² | ● | ● | ● | ● | ● | ● | ● | ● | ● | ● | ● | ● | ● |
| Chinese Taipei | ● | ● | ● | ● | ● | ● | ● | ● | ● | ● | ● | ● | ● |
| Czech Republic | ● | ● | ● | ● | ● | ● | ● | ● | ● | ● | ● | ● | ● |
| England | ● | ● | ● | ● | ● | ● | ● | ● | ● | ● | ● | ● | ● |
| First in the World Consort., IL | ● | ● | ● | ● | ● | ● | ● | ● | ● | ● | ● | ● | ● |
| Japan | ● | ● | ● | ● | ● | ● | ● | ● | ● | ● | ● | ● | ● |
| Korea, Rep. of | ● | ● | ● | ● | ● | ● | ● | ● | ● | ● | ● | ● | ● |
| Michigan | ● | ● | ● | ● | ● | ● | ● | ● | ● | ● | ● | ● | ● |
| Michigan Invitational Group, MI | ● | ● | ● | ● | ● | ● | ● | ● | ● | ● | ● | ● | ● |
| Naperville Sch. Dist. #203, IL | ● | ● | ● | ● | ● | ● | ● | ● | ● | ● | ● | ● | ● |
| Netherlands | ● | ● | ● | ● | ● | ● | ● | ● | ● | ● | ● | ● | ● |
| Project SMART Consortium, OH | ● | ● | ● | ● | ● | ● | ● | ● | ● | ● | ● | ● | ● |
| Singapore | ● | ● | ● | ● | ● | ● | ● | ● | ● | ● | ● | ● | ● |

- Major Emphasis
- Moderate Emphasis
- Minor/No Emphasis
- Data Not Available

Background data provided by coordinators from participating entities.

² Canada: Results shown are for the majority of provinces.

¹ Southwest Pennsylvania: Covering a workforce region of 118 autonomous districts, a representative response for these questions could not be provided.

What Content Do Teachers Emphasize at the Eighth Grade?

The intended curriculum is transformed into the implemented curriculum by the actions and decisions of teachers. Teachers and the instructional approaches they use determine the mathematics and science students learn. They structure the content and pace of lessons, introducing new material, selecting various instructional activities, and monitoring students' developing understanding of the concepts studied. Teachers may help students use technology and tools to investigate ideas, analyze students' work for misconceptions, and promote positive attitudes toward mathematics and science. To collect information about instruction and the implemented curriculum, TIMSS administered a questionnaire to teachers asking them about many of these issues.

Because the sampling for the teacher questionnaires was based on participating students, teachers' responses do not necessarily represent all eighth-grade mathematics or science teachers in each participating entity. Rather, they represent teachers of the representative samples of students assessed. It is important to note that when information from the teacher questionnaire is reported, the student is always the unit of analysis. That is, the data shown are the percentages of *students* whose teachers reported on various characteristics or instructional strategies. Using the student as the unit of analysis makes it possible to describe the mathematics and science instruction received by representative samples of students. Although this perspective may differ from that obtained by simply collecting

information from teachers, it is consistent with the TIMSS goals of examining the educational contexts and performance of students.

The teachers who completed the questionnaires were the mathematics and science teachers of the students who took the TIMSS 1999 test. The general sampling procedure was to sample two mathematics classes from each participating school, administer the test to those students, and ask both their mathematics and science teachers to complete the questionnaire. Thus, the information about instruction is tied directly to the students tested. Sometimes, however, teachers did not complete the questionnaire assigned to them, so most entities had some percentage of students for whom no teacher questionnaire information is available. The remaining exhibits in this chapter have special notations on this point.² For a TIMSS 1999 participating entity (country, state, district, or consortium) where teacher responses are available for 70 to 84 percent of the students, an "r" is included next to the data. Where teacher responses are available for 50 to 69 percent of students, an "s" is included; where they are available for less than 50 percent, an "x" replaces the data. Southwest Pennsylvania teacher response rate exceeded these limits; hence, no special notations or associated limitations to the data apply.

Teachers of the mathematics classes tested were asked what subject matter they emphasized most in their classes (e.g., geometry, algebra, various combinations of content, etc.). Their responses, given in Exhibit 4.4, reveal that most eighth-grade students around the world are being taught mathematics with an integration of content areas. Internationally on average, more than half the students were taught a combination of

² These same notations to the data concerning response rate are included in exhibits in chapters 5 and 7, and apply to data provided by students and schools as well as by teachers.

| | Percentage of Students Whose Teachers Reported the Subject Matter Emphasized Most in Their Grade 8 Mathematics Class | | | | | |
|---------------------------------|--|--|-------------------------------|-----------|-----------|-----------|
| | Mainly Number | Combined Algebra, Geometry, Number, etc. | Combined Algebra and Geometry | Algebra | Geometry | Other |
| International Average | 14 (0.4) | 55 (0.6) | 19 (0.5) | 8 (0.4) | 3 (0.2) | 2 (0.2) |
| United States | 28 (3.0) | 32 (3.4) | 6 (1.6) | 27 (2.7) | 1 (0.8) | 6 (1.4) |
| <i>Pennsylvania</i> | 23 (5.7) | 27 (6.5) | 6 (2.1) | 39 (5.0) | 1 (0.5) | 5 (1.7) |
| Southwest Pennsylvania | 20 (5.8) | 24 (5.7) | 11 (4.5) | 36 (5.7) | 3 (2.1) | 6 (2.2) |
| Australia | -- | -- | -- | -- | -- | -- |
| Canada | r 26 (3.0) | r 53 (2.8) | r 6 (1.6) | r 6 (1.4) | r 1 (0.0) | r 9 (1.9) |
| Chinese Taipei | 2 (1.1) | 57 (4.2) | 24 (3.6) | 4 (1.7) | 9 (2.6) | 4 (1.6) |
| Czech Republic | 0 (0.2) | 76 (3.9) | 19 (3.9) | 4 (1.2) | 0 (0.0) | 0 (0.0) |
| England | s 0 (0.0) | s 100 (0.0) | s 0 (0.0) | s 0 (0.0) | s 0 (0.0) | s 0 (0.0) |
| First in the World Consort., IL | 9 (3.9) | 32 (4.3) | 5 (3.5) | 35 (8.5) | 18 (8.0) | 0 (0.0) |
| Japan | 7 (2.0) | 30 (4.1) | 35 (4.0) | 16 (3.1) | 9 (2.5) | 4 (1.6) |
| Korea, Rep. of | 6 (1.9) | 51 (4.0) | 20 (3.1) | 20 (3.4) | 2 (1.1) | 2 (0.9) |
| Michigan | 23 (3.9) | 23 (4.9) | 6 (1.4) | 43 (4.2) | 1 (1.1) | 4 (2.2) |
| Michigan Invitational Group, MI | 9 (2.8) | 35 (8.5) | 4 (0.2) | 50 (8.5) | 0 (0.0) | 2 (0.1) |
| Naperville Sch. Dist. #203, IL | 4 (2.0) | 1 (0.0) | 5 (0.4) | 91 (2.1) | 0 (0.0) | 0 (0.0) |
| Netherlands | 4 (3.2) | 77 (4.6) | 13 (2.9) | 2 (1.1) | 1 (0.8) | 3 (1.6) |
| Project SMART Consortium, OH | 34 (7.5) | 24 (4.8) | 1 (1.2) | 31 (8.0) | 2 (2.2) | 7 (4.0) |
| Singapore | 8 (2.3) | 46 (4.5) | 12 (2.9) | 29 (3.7) | 0 (0.0) | 5 (1.7) |

Background data provided by teachers.

States in italics did not fully satisfy guidelines for sample participation rates (see Appendix A).

() Standard errors appear in parentheses. Because results are rounded to the nearest whole number, some totals may appear inconsistent.

A dash (-) indicates data are not available.

An "r" indicates teacher response data available for 70-84% of students. An "s" indicates teacher response data available for 50-69% of students.

SOURCE: IEA Third International Mathematics and Science Study (TIMSS) 1998-1999

mathematics topics (i.e., combined algebra, geometry, number, etc.), and almost 20 percent were in classes emphasizing algebra and geometry combined.

Just as in TIMSS 1995,³ the mathematics curriculum in the U.S. at the eighth grade does not appear to be as advanced as in other countries. About one-third of the U.S. eighth-grade students were in mathematics classes where the emphasis was on the combination of algebra, geometry,

number, etc., but more than one-quarter were in classes emphasizing mainly number. None of the comparator countries except Canada had a comparable proportion of students in classes emphasizing mainly number, and across all the TIMSS 1999 countries a mere 14 percent of students were in such classes.

Even when U.S. eighth graders were being taught algebra, it was usually as a single emphasis. More than one-quarter of the students were in

3 Peak, L. (1996), *Pursuing Excellence: A Study of U.S. Eighth-Grade Mathematics and Science Teaching, Learning, Curriculum, and Achievement in International Context*, NCES 97-198, Washington, DC: National Center for Education Statistics.

classes emphasizing only algebra, compared with six percent in classes with a combined algebra and geometry emphasis. This is almost a reverse of the international pattern of 20 percent in algebra and geometry combined compared with eight percent in algebra only.

The Benchmarking states generally resembled the United States overall in the percentages of students in classes emphasizing various mathematics subject matter. Relative emphasis on mathematics subject matter varied more across the districts and consortia. Similar to the United States overall, most Benchmarking jurisdictions had much higher percentages of students whose teachers reported emphasizing mainly number at the eighth grade than did those in the top-performing comparator countries. These data suggest that many students in the U.S. continue to be taught number concepts at the eighth grade while their peers in other countries study topics in geometry and algebra, as discussed below. This is supported by previous TIMSS studies that showed that U.S. eighth-grade students who were not in Algebra 1 courses (approximately 75 to 80 percent of students) continued to receive instruction in arithmetic, estimation, and “measurement – units” compared with their peers internationally who have completed these topics and received more focused instruction on integers, rational numbers, “exponents, roots and radicals,” and on geometry, algebra, and proportionality topics.⁴

In the Benchmarking comparator jurisdictions, the percentages of students in classes emphasizing mainly number is striking, and ranged from four percent in Naperville School District to 34 percent in Project SMART. Southwest Pennsylvania reported 20 percent in such classes compared with 23

percent in Pennsylvania and 28 percent in the United States. In contrast, higher-performing countries and jurisdictions typically reported less than 10 percent of students whose teachers indicate a primary emphasis on mainly number.

Science teachers from the Benchmarking jurisdictions and the countries where eighth-grade science was taught as a general or integrated course were asked what subject matter they emphasized most in their classes (general science, earth science, biology, etc.). Their responses, shown in Exhibit 4.5, reveal that on average across all the TIMSS 1999 single-science countries, more than half the eighth-grade students (58 percent) were in classes where the emphasis was on general or integrated science. Next most common was biology with 14 percent, and physical science (physics and chemistry combined) with 11 percent.

In the United States, 41 percent of students were in classes emphasizing general science, 28 percent earth science, and 21 percent physical science. Just five percent of U.S. students were in science classes emphasizing biology, three percent chemistry, and two percent physics. The United States was unusual in its emphasis on earth science. Among the 21 single-science countries in TIMSS, only Canada, Italy, and the U.S. had more than 10 percent of their students in classes emphasizing earth science. It was more common for single-science countries to place emphasis on physical science.⁵

There was considerable variation across the Benchmarking comparator jurisdictions in the reported subject matter emphasis in science classes. Among them, the percentage of students in classes emphasizing general science ranged from 16 percent in Pennsylvania to 68 percent in

4 Schmidt, W.H., McKnight, C.C., and Raizen, S.A. (1997), *A Splintered Vision: An Investigation of U.S. Science and Mathematics Education*, Dordrecht, the Netherlands: Kluwer Academic Publishers.

5 See Exhibit 5.17 in the *Science Benchmarking Report, TIMSS 1999 – Eighth Grade: Achievement for U.S. States and Districts in an International Context*.

| | Percentage of Students Whose Teachers Reported the Subject Matter Emphasized Most in Their Grade 8 Science Class | | | | | | |
|---------------------------------------|--|---------------|----------|----------|-----------|--------------------------------------|----------|
| | General/Integrated Science | Earth Science | Biology | Physics | Chemistry | Physical Science (chemistry/physics) | Other |
| International Average ¹ | 58 (0.8) | 5 (0.4) | 14 (0.5) | 6 (0.4) | 4 (0.4) | 11 (0.6) | 2 (0.3) |
| United States <i>r</i> | 41 (4.7) | 28 (4.8) | 5 (1.5) | 2 (0.8) | 3 (1.0) | 21 (3.1) | 1 (0.4) |
| <i>Pennsylvania</i> <i>r</i> | 16 (3.2) | 40 (5.5) | 6 (2.5) | 0 (0.0) | 2 (0.9) | 35 (6.1) | 1 (0.9) |
| Southwest Pennsylvania | 31 (7.8) | 18 (6.6) | 10 (5.8) | 2 (2.1) | 7 (3.8) | 31 (5.9) | 0 (0.0) |
| Australia <i>r</i> | 83 (2.6) | 0 (0.3) | 5 (1.6) | 1 (0.4) | 4 (1.3) | 2 (0.7) | 4 (1.2) |
| Canada <i>r</i> | 55 (3.5) | 14 (2.3) | 6 (1.7) | 1 (0.7) | 1 (0.6) | 19 (2.7) | 3 (1.2) |
| Chinese Taipei ² | -- | -- | -- | -- | -- | -- | -- |
| Czech Republic ² | -- | -- | -- | -- | -- | -- | -- |
| England | -- | -- | -- | -- | -- | -- | -- |
| First in the World Consort., IL | 20 (9.3) | 0 (0.0) | 15 (1.5) | 0 (0.0) | 7 (1.0) | 47 (8.1) | 11 (4.7) |
| Japan | 64 (4.6) | 1 (1.0) | 7 (2.4) | 6 (2.1) | 11 (2.7) | 6 (2.1) | 5 (1.9) |
| Korea, Rep. of | 49 (4.0) | 2 (1.0) | 10 (2.0) | 5 (1.6) | 5 (1.7) | 26 (3.2) | 4 (1.6) |
| Michigan <i>r</i> | 54 (5.7) | 9 (3.9) | 3 (2.5) | 2 (2.1) | 0 (0.3) | 32 (5.0) | 0 (0.4) |
| Michigan Invitational Group, MI | 47 (4.3) | 32 (3.3) | 4 (0.2) | 0 (0.0) | 3 (0.7) | 14 (2.6) | 0 (0.0) |
| Naperville Sch. Dist. #203, IL | 68 (3.4) | 0 (0.0) | 0 (0.0) | 13 (0.7) | 0 (0.0) | 18 (3.5) | 0 (0.0) |
| Netherlands ² | -- | -- | -- | -- | -- | -- | -- |
| Project SMART Consortium, OH <i>r</i> | 22 (4.2) | 33 (3.3) | 11 (3.0) | 0 (0.0) | 7 (3.1) | 22 (3.4) | 4 (1.7) |
| Singapore | 69 (4.1) | 0 (0.0) | 5 (2.0) | 4 (1.8) | 7 (2.3) | 11 (2.5) | 4 (1.6) |

Background data provided by teachers.

- 1 International average is for countries where science is taught as a single general/integrated science course at grade 8.
- 2 Data are not available for these countries where science is taught as separate courses at grade 8.

States in italics did not fully satisfy guidelines for sample participation rates (see Appendix A).

() Standard errors appear in parentheses. Because results are rounded to the nearest whole number, some totals may appear inconsistent.

A dash (-) indicates data are not available.

An "r" indicates teacher response data available for 70-84% of students.

Naperville. Southwest Pennsylvania reported 31 percent of students in such classes. Among the Benchmarking comparator jurisdictions, earth science received least emphasis in First in the World and Naperville (similarly with some of the high-achieving countries such as Singapore, Korea, and Japan).

What Can Be Learned About the Curriculum?

In contrast to the United States, most countries around the world have well-established, centrally-mandated national curricula. Recently, however, states and districts in the U.S. have been making great strides in establishing content standards and curriculum frameworks to guide curriculum implementation in schools. Furthermore, many education systems in the U.S. have begun to assess whether the intended curriculum in mathematics and science is being attained or learned by their students.

Although effort has been made to develop rigorous curriculum standards, the intended mathematics curriculum in the United States overall and in many Benchmarking jurisdictions does not seem as advanced or focused as that in other countries. Students in the U.S. are generally taught more topics with less depth, with each often spread over the course of more grades, than are their peers in other nations.⁶ This lack of focus has been cited as a potential explanation for the relatively poor academic performance of U.S. students compared with those in other nations.⁷

Thoroughly examining the Benchmarking jurisdictions' results in an international context can provide insights into what students are expected to learn in mathematics and science, what is taught in classrooms, and what policies and practices provide the best match between the intended and the implemented curriculum to improve student achievement.

6 Schmidt, W.H., McKnight, C.C., and Raizen, S.A. (1997), *A Splintered Vision: An Investigation of U.S. Science and Mathematics Education*, Dordrecht, the Netherlands: Kluwer Academic Publishers.

7 Mayer, D.P., Mullens, J.E., and Moore, M.T. (2000), *Monitoring School Quality: An Indicators Report*, NCES 2001-030, Washington, DC: National Center for Education Statistics.

What We Teach and Who We Teach Matters



Through TIMSS 1995, and again through TIMSS 1999, educators learned that curriculum matters. Bill Schmidt and others have well documented the disparity between the U.S. approach to mathematics and science curricula compared to high-achieving countries throughout the world. Typically, the U.S. approach tends to include many topics, sometimes three to four times that of other countries, allowing little in-depth exploration or mastery. These documented findings have led to the characterization of U.S. curricula as “a mile wide and an inch deep.”⁸

Further, TIMSS presents good evidence that children cannot master what they have not been taught. How curricula are organized, and how access to that curricula is provided for all children, are crucial issues for consideration. One example that can be drawn from the TIMSS 1999 Benchmarking Study provides interesting evidence that *what* we teach makes a difference. We have included the state of Michigan and the Michigan Invitational Group as comparators in all of the report exhibits. We chose to do this because Southwest Pennsylvania achievement results are often quite similar to those of the state of Michigan, and the Michigan Invitational Group achievement is often significantly better than both the state of Michigan and Southwest Pennsylvania. The schools representing the Michigan Invitational Group were similar to the sample of the state of Michigan except for one important factor: these schools were actively implementing curricular materials in mathematics that were designated by the U.S. Department of Education as “exemplary.”⁹ Thus, the Invitational Group serves as an important test case using a quasi-experimental design (with the state of Michigan serving as a control group) to explore the relationship of exemplary curriculum materials with achievement.

⁸ Schmidt, W.H., McKnight, C.C., and Raizen, S.A. (1997), *A Splintered Vision: An Investigation of U.S. Science and Mathematics Education*, Dordrecht, the Netherlands: Kluwer Academic Publishers.

⁹ Michigan Department of Education.

While what educators teach makes a difference, as indicated in a variety of ways through the TIMSS 1995 and 1999 findings, what is taught cannot influence students who do not have adequate and equal access to the curriculum. *Who* has access to the curriculum matters as well. Exhibit 4.6 examines the issue of content tracking in mathematics and science. The implemented curriculum may include various configurations in organizing classes and delivering content. Schools responded to a variety of questions related to these configurations and strategies, including the availability of remedial and enrichment experiences, ability grouping within classes, and all classes studying similar content but at different levels of difficulty. Additionally, schools provided information about whether they organize their mathematics and science curricula to teach different content to different classes. This latter question surfaces the issue of content tracking, where only **some** students are taught **some** content. This may result in, for example, only those students perceived as most academically able being taught algebra.

In Southwest Pennsylvania, 57 percent of the students attended schools that use content tracking as a way of organizing mathematics classes, similarly to Pennsylvania with 59 percent. Interestingly, these results indicate far more mathematics content tracking in Pennsylvania and the region as compared to the U.S. (37 percent) or the international average (17 percent). Perhaps even more importantly, when comparing the achievement of those students in schools reporting content tracking with those in schools that reported no content tracking, there is little difference in achievement, and in some cases, including Southwest Pennsylvania, students in schools reporting no content tracking had higher levels of achievement.¹⁰ While content tracking appears fairly common in some countries and jurisdictions in mathematics, it seems not to be prevalent in science. While a couple of comparator countries and jurisdictions apply content tracking in both mathematics and science (Netherlands and Singapore), the international averages indicating content tracking in mathematics and science are equally low (17 percent in mathematics, 14 percent in science). Southwest Pennsylvania reported 17 percent content tracking in science, indicating a reverse relationship to tracking practices in mathematics. Similarly with achievement findings in mathematics, there appears to be no achievement-related benefit to content tracking in science.

¹⁰ Please note that a test of statistical significance comparing the achievement levels was not conducted for this exhibit.

SOURCE: IEA Third International Mathematics and Science Study (TIMSS) 1998–1999

| | Mathematics | | | | Science | | | |
|---------------------------------|---|---------------------|---------------------|---------------------|---|---------------------|---------------------|---------------------|
| | Different Content Provided to Different Classes in School | | | | Different Content Provided to Different Classes in School | | | |
| | Yes | | No | | Yes | | No | |
| | Percent of Students | Average Achievement | Percent of Students | Average Achievement | Percent of Students | Average Achievement | Percent of Students | Average Achievement |
| International Average | 17 (0.5) | 492 (2.6) | 83 (0.5) | 487 (0.9) | 14 (0.5) | 491 (2.9) | 86 (0.5) | 497 (0.8) |
| United States | r 37 (4.2) | 520 (6.7) | r 63 (4.2) | 490 (4.9) | r 12 (2.7) | 509 (17.8) | r 88 (2.7) | 519 (4.6) |
| <i>Pennsylvania</i> | 59 (5.5) | 513 (8.0) | 41 (5.5) | 511 (9.4) | 25 (4.7) | 535 (5.1) | 75 (4.7) | 535 (8.8) |
| Southwest Pennsylvania | 57 (8.0) | 514 (9.5) | 43 (8.0) | 523 (9.8) | 17 (7.6) | 541 (28.0) | 83 (7.6) | 547 (7.3) |
| Australia | 33 (3.9) | 528 (10.3) | 67 (3.9) | 523 (5.7) | 18 (3.0) | 536 (11.6) | 82 (3.0) | 542 (5.0) |
| Canada | s 17 (3.0) | 532 (7.7) | s 83 (3.0) | 521 (3.7) | x x | x x | x x | x x |
| Chinese Taipei | 18 (3.1) | 573 (10.5) | 82 (3.1) | 588 (4.3) | 16 (3.2) | 561 (10.3) | 84 (3.2) | 571 (4.5) |
| Czech Republic | 7 (3.0) | 517 (25.7) | 93 (3.0) | 519 (3.9) | 6 (2.9) | 516 (16.1) | 94 (2.9) | 540 (4.0) |
| England | r 0 (0.0) | ~ ~ | r 100 (0.0) | 500 (4.6) | r 0 (0.0) | ~ ~ | r 100 (0.0) | 542 (5.0) |
| First in the World Consort., IL | r 88 (0.4) | 562 (7.1) | r 12 (0.4) | 521 (24.1) | r 0 (0.0) | ~ ~ | r 100 (0.0) | 560 (6.0) |
| Japan | 13 (2.9) | 595 (9.5) | 87 (2.9) | 576 (2.2) | 4 (1.8) | 555 (11.2) | 96 (1.8) | 549 (2.4) |
| Korea, Rep. of | 38 (4.5) | 595 (2.9) | 62 (4.5) | 584 (2.5) | 16 (2.8) | 550 (4.5) | 84 (2.8) | 548 (2.9) |
| Michigan | 58 (6.9) | 527 (7.8) | 42 (6.9) | 525 (8.1) | 4 (2.6) | 519 (12.0) | 96 (2.6) | 557 (7.0) |
| Michigan Invitational Group, MI | 31 (1.1) | 527 (13.4) | 69 (1.1) | 535 (6.1) | 0 (0.0) | ~ ~ | 100 (0.0) | 565 (6.3) |
| Naperville Sch. Dist. #203, IL | 57 (1.5) | 571 (4.1) | 43 (1.5) | 566 (3.3) | 0 (0.0) | ~ ~ | 100 (0.0) | 584 (4.1) |
| Netherlands | r 60 (6.8) | 535 (10.9) | r 40 (6.8) | 548 (14.1) | r 61 (6.6) | 534 (11.0) | r 39 (6.6) | 562 (11.4) |
| Project SMART Consortium, OH | r 63 (1.2) | 518 (11.3) | r 37 (1.2) | 515 (10.8) | 25 (1.4) | 537 (17.4) | 75 (1.4) | 537 (10.3) |
| Singapore | 82 (3.6) | 588 (5.7) | 18 (3.6) | 686 (6.5) | 83 (3.5) | 546 (7.2) | 17 (3.5) | 673 (7.7) |

Background data provided by schools.

States in italics did not fully satisfy guidelines for sample participation rates (see Appendix A).

() Standard errors appear in parentheses. Because results are rounded to the nearest whole number, some totals may appear inconsistent.

A tilde (~) indicates insufficient data to report achievement.

An "r" indicates school response data available for 70-84% of students. An "s" indicates school response data available for 50-69% of students. An "x" indicates school response data available for <50% of students.



How do we explain this phenomenon and make sense of it? Is the practice of content tracking, seemingly a widespread U.S. phenomenon in mathematics, supported by the resulting achievement data? Again, Bill Schmidt's extensive work with the curriculum data from TIMSS 1995 (and his initial work with TIMSS 1999 data, as well) is illuminating:

What does it mean in concrete terms to have had differing access to educational possibilities? It could have meant being taught in courses with different official curricula, curricula that affected the content covered, emphasized, and omitted in those students' courses. It could have meant being taught in classes using different textbooks – textbooks that differed not only in the title but in content, goals, and in the kind of curricula they were intended to support – further setting limits on students' abilities to achieve by their own efforts. It could also have meant being taught by teachers who emphasized different content, included more review, and shaped their expectations of what students could do based on the course in which students found themselves. Most of all it could have meant a devastating combination of these things.

These [sic] differences are not necessary; they are created by choice and are, therefore, far from being fundamental as distributed responsibility for education. These [sic] differences likely have consequences. Some children achieve less, not because they work less hard or have less ability to master mathematics or science, but because of where they attend schools and the policies that determine what educational possibilities they will have access to. To not be able to be the best that we can be is sad. To have this true by policy is ethically bankrupt, if not socially criminal. Some get and some don't get and we have chosen, perhaps without knowing, to make this true through our practices of differential access.¹¹

While one may agree or disagree with the conclusions Schmidt and colleagues have drawn, the issues and policies that seem to inform curricular choices, in terms of coherence and focus, as well as access, are important considerations if the region is committed to developing a mathematically and scientifically literate citizenry and workforce.

¹¹ Schmidt, W. H., McKnight, C. C., Cogan, L. S., Jakwerth, P. M., and Houang, R. T. (1999), *Facing the Consequences: Using TIMSS for a Closer Look at U.S. Mathematics and Science Education*, Dordrecht, the Netherlands: Kluwer Academic Publishers.

Chapter 5

Mathematics and Science Instruction



Cynthia A. Tananis, Ed.D.

Steven J. Chrostowski, Ed.M.



In this chapter:

- What Preparation and Confidence Do Teachers Have for Teaching Mathematics or Science?
- Selected Teaching Strategies in Mathematics and Science
- How Do Students Perceive Their Ability in Mathematics and Science?

A Focus for Continued Exploration

The Complexity of Instruction



Chapter 5 presents information about mathematics and science teachers and instruction. Teachers' reports are given on their educational background and confidence in their ability to teach mathematics and science. Information is also provided about the emphasis on reasoning and problem-solving in instruction, use of experiments in science and calculators in mathematics, and the role of homework. Additionally, student self-concept is examined in relation to achievement. The chapter concludes with a focus on the complexity of the instructional context and what lessons TIMSS offers related to instruction.

What Preparation and Confidence Do Teachers Have for Teaching Mathematics or Science?

Exhibit 5.1 presents mathematics teachers' reports about their major areas of study during their post-secondary teacher preparation programs, and Exhibit 5.2 does so for science teachers.¹ Teachers' undergraduate and graduate studies give some indication of their preparation to teach mathematics or science. Also, research shows that higher achievement in mathematics and science is associated with teachers having a bachelor's and/or master's degree in mathematics or science, respectively.² According to their teachers, however, U.S. eighth-grade students were less likely than those in other countries to be taught mathematics or science by teachers with a major area of study in the discipline they were teaching.

On average internationally, 76 percent of students were taught by mathematics teachers who had mathematics as a major area of study. Note that teachers can have dual majors, or different majors at the undergraduate and graduate level. This compares with 48 percent for the United States, a figure not too different from that for many Benchmarking participants, although there was a range of 57 percent in Michigan to 81 percent in First in the World among the comparator jurisdictions. Suffice it to say that in the United States and most Benchmarking entities, a smaller percentage of students than the international average was taught by mathematics teachers with a major in mathematics. Canada was the only comparator nation that reported a lower percentage than the United States. Southwest Pennsylvania and Pennsylvania both reported 65 percent, higher than the U.S. average, but still substantially lower than the 80 to 90 percent reported by the higher-achieving countries and Benchmarking jurisdictions.

Internationally on average, 37 percent of the students were taught by mathematics teachers with mathematics education as a major area of study. In comparison, more than half of the students were taught by teachers with this major in the comparator states of Michigan and Pennsylvania and in the comparator districts and consortia of First in the World and Project SMART, as well as in Southwest Pennsylvania. Internationally, 32 percent of the students were taught by mathematics teachers with education as a major area of study. Significantly more students in the United States (54 percent) had mathematics teachers with an education major than did students internationally. In general across the

1 The same notations to the data concerning response rate described in chapter 4 apply to all exhibits in chapter 5.

2 Goldhaber, D.D. and Brewer, D.J. (1997), "Evaluating the Effect of Teacher Degree Level on Educational Performance" in W. Fowler (ed.), *Developments in School Finance*, 1996, NCES 97-535, Washington DC: National Center for Education Statistics; Darling-Hammond, L. (2000), *Teacher Quality and Student Achievement: A Review of State Policy Evidence*, Education Policy Analysis Archives, 8(1).

Exhibit 5.1: Mathematics Teachers' Major Area of Study in Their BA, MA, or Teacher Training Certification Program*

| | Percentage of Students Whose Mathematics Teachers Reported Having the Major Area of Study ¹ | | | |
|---------------------------------|--|-----------------------|------------|------------|
| | Mathematics | Mathematics Education | Education | Other |
| International Average | 76 (0.5) | 37 (0.6) | 32 (0.6) | 54 (0.6) |
| United States | 48 (3.1) | 42 (3.2) | 54 (3.4) | 54 (4.2) |
| <i>Pennsylvania</i> | 65 (6.4) | 59 (5.2) | 61 (5.8) | 39 (5.5) |
| Southwest Pennsylvania | 65 (4.9) | 64 (6.5) | 64 (7.7) | 37 (8.5) |
| Australia | 66 (4.6) | 35 (4.5) | 44 (4.0) | 71 (4.0) |
| Canada | 22 (2.8) | 20 (2.3) | 49 (3.2) | 80 (2.4) |
| Chinese Taipei | 82 (3.7) | 39 (4.2) | 32 (3.6) | 30 (3.8) |
| Czech Republic | 90 (3.5) | 36 (5.7) | 34 (5.5) | 89 (3.4) |
| England | s 81 (2.8) | s 56 (3.6) | s 44 (3.4) | s 54 (2.9) |
| First in the World Consort., IL | 81 (8.3) | 83 (7.6) | 77 (3.4) | 42 (8.8) |
| Japan | 91 (2.6) | 31 (3.9) | 15 (3.2) | 24 (3.6) |
| Korea, Rep. of | 55 (4.2) | 61 (4.0) | 19 (3.2) | 13 (2.5) |
| Michigan | 57 (6.0) | 59 (6.6) | 64 (6.3) | 69 (5.6) |
| Michigan Invitational Group, MI | 71 (6.5) | 38 (9.4) | 55 (10.0) | 60 (6.0) |
| Naperville Sch. Dist. #203, IL | 73 (5.4) | 30 (2.8) | 50 (5.9) | 57 (4.8) |
| Netherlands | 77 (5.1) | 18 (4.7) | 12 (4.3) | 35 (5.8) |
| Project SMART Consortium, OH | 67 (4.6) | 61 (6.4) | 61 (7.7) | 45 (5.4) |
| Singapore | 83 (3.5) | 35 (4.4) | 48 (4.8) | 77 (3.8) |

Background data provided by teachers.

* Due to refinements in data analysis procedures, results may differ slightly from previously published reports.

1 Teachers who responded that they majored in more than one area are reflected in all categories that apply.

States in italics did not fully satisfy guidelines for sample participation rates (see Appendix A).

() Standard errors appear in parentheses. Because results are rounded to the nearest whole number, some totals may appear inconsistent.

An "s" indicates teacher response data available for 50-69% of students.

SOURCE: IEA Third International Mathematics and Science Study (TIMSS) 1998-1999

Benchmarking participants, including Southwest Pennsylvania, about twice as many teachers reported an education major as did teachers internationally. It is clear that teachers in the United States have less "in field" mathematics preparation than their counterparts around the world.

Exhibit 5.2 examines teacher preparation in science. In countries such as the United States that offer eighth-grade science as a single general subject, 42 percent of students on average interna-

tionally were in a science class taught by a teacher whose major area of study was biology, 23 percent physics, 30 percent chemistry, 44 percent science education, 30 percent general education, and 44 percent held other degrees. The United States was similar to the international profile, although with somewhat fewer students taught by physics and chemistry teachers and considerably more taught by teachers with a major in general education or some other area.

| | Percentage of Students Whose Science Teachers Reported Having the Major Area of Study ¹ | | | | | |
|------------------------------------|--|------------|------------|-------------------|------------|------------|
| | Biology | Physics | Chemistry | Science Education | Education | Other |
| International Average ² | 42 (0.8) | 23 (0.7) | 30 (0.8) | 44 (0.9) | 30 (0.7) | 44 (0.8) |
| United States | 47 (3.5) | 13 (2.2) | 21 (3.0) | 43 (3.7) | 56 (3.6) | 53 (3.5) |
| <i>Pennsylvania</i> | 40 (4.4) | 9 (2.9) | 20 (5.0) | 52 (4.5) | 64 (4.6) | 41 (7.2) |
| Southwest Pennsylvania | 36 (5.5) | 9 (4.5) | 15 (4.2) | 50 (7.0) | 65 (7.3) | 43 (6.0) |
| Australia | 58 (4.2) | 23 (2.9) | 40 (3.2) | 52 (3.2) | 44 (3.6) | 54 (3.5) |
| Canada | 36 (2.8) | 8 (1.9) | 17 (2.3) | 28 (2.9) | 51 (3.0) | 70 (2.5) |
| Chinese Taipei ³ | -- | -- | -- | -- | -- | -- |
| Czech Republic ³ | -- | -- | -- | -- | -- | -- |
| England | s 49 (4.6) | s 47 (3.8) | s 54 (3.8) | s 54 (3.7) | s 44 (3.6) | s 47 (4.2) |
| First in the World Consort., IL | 60 (7.0) | 8 (6.0) | 24 (4.6) | 44 (4.1) | 70 (7.2) | 55 (4.7) |
| Japan | r 31 (4.7) | r 30 (4.5) | r 37 (4.7) | r 44 (5.0) | r 18 (3.2) | r 25 (3.8) |
| Korea, Rep. of | 27 (3.5) | 24 (3.5) | 28 (3.6) | 38 (3.9) | 10 (2.3) | 10 (2.2) |
| Michigan | r 43 (6.0) | r 11 (4.3) | r 19 (5.3) | r 51 (6.2) | r 72 (4.7) | r 62 (6.6) |
| Michigan Invitational Group, MI | 43 (6.6) | 16 (2.0) | 24 (3.5) | 63 (5.3) | 60 (6.3) | 58 (4.7) |
| Naperville Sch. Dist. #203, IL | 58 (3.9) | 31 (2.4) | 39 (4.0) | 36 (2.3) | 61 (3.8) | 47 (5.3) |
| Netherlands ³ | -- | -- | -- | -- | -- | -- |
| Project SMART Consortium, OH | 39 (2.2) | 22 (3.7) | 35 (3.5) | 73 (4.4) | 58 (3.3) | 43 (6.2) |
| Singapore | 48 (4.7) | 20 (3.4) | 53 (4.5) | 46 (4.3) | 40 (4.3) | 60 (4.4) |

Background data provided by teachers.

- 1 Teachers who responded that they majored in more than one area are reflected in all categories that apply.
- 2 International average is for countries where science is taught as a single general/integrated science course at grade 8.
- 3 Data are not available for these countries where science is taught as separate courses at grade 8.

States in italics did not fully satisfy guidelines for sample participation rates (see Appendix A).

() Standard errors appear in parentheses. Because results are rounded to the nearest whole number, some totals may appear inconsistent.

An "r" indicates teacher response data available for 70-84% of students. An "s" indicates teacher response data available for 50-69% of students.

Among Benchmarking participants, in almost every jurisdiction the majority of students were in science classes in which the teacher's major area was science education or general education. Teachers with a major in physics or chemistry were rare. These trends were apparent in Southwest Pennsylvania as well, with 50 percent of students taught by teachers reporting a science education degree and 65 percent a general education degree. In countries such as Chinese Taipei,

the Czech Republic, and the Netherlands, where the science subjects are taught as separate courses, typically greater percentages of students were taught science by teachers with a major in the area they were teaching. On average across all the TIMSS 1999 separate-science countries, 85 percent of students were taught biology by teachers with a major in biology, 75 percent were taught physics by a physics major, and 87 percent were taught chemistry by a chemistry major.³

3 See the full Benchmarking reports for more detailed information: *Mathematics Benchmarking Report, TIMSS 1999 – Eighth Grade: Achievement for U.S. States and Districts in an International Context*, and *Science Benchmarking Report, TIMSS 1999 – Eighth Grade: Achievement for U.S. States and Districts in an International Context*.

To gauge teachers' confidence in their ability to teach mathematics and science topics, TIMSS constructed an index of teachers' confidence in their preparation to teach mathematics (CPTM) and science (CPTS), presented in Exhibits 5.3 and 5.4, respectively. Teachers were asked how well prepared they felt to teach each of 12 mathematics and 10 science content topics. There were three possible responses: very well prepared was assigned a value of three, somewhat prepared two, and not well prepared one. Students were assigned to the high level of the index if their teachers reported feeling very well prepared, on average, across the topics (2.75 or higher). The medium level indicates that teachers reported being somewhat to well prepared (averages from 2.25 to 2.75), and the low level that they felt only somewhat prepared or less (averages less than 2.25).

The results show that average mathematics achievement is related to how well prepared teachers felt they were to teach mathematics, with higher achievement related to higher levels of teachers' confidence. On average internationally, teachers reported relatively high degrees of confidence, with 63 percent of students taught by teachers who believed they were very well prepared. Interestingly, for the United States as a whole and most Benchmarking entities, more students were taught mathematics by teachers confident about their preparation than in almost all the comparator countries. Interpreting these results should take several factors into account. For example, cultural issues may dictate that teachers in the high-scoring Asian countries are more reserved about reporting their strengths and abilities. Also, when the mathematics curriculum is more challenging, teachers may feel less confi-

dent in their academic and pedagogical preparation. Nevertheless, it appears that in relation to both high- and low-performing countries around the world, teachers in many Benchmarking entities and in the United States overall may be overconfident about their preparation to teach eighth-grade mathematics.

In science, teachers reported only moderate confidence in their preparation to teach science, with just 20 percent of students, on average internationally, taught by teachers who believed they were very well prepared and another 41 percent by teachers somewhat to well prepared. On average across countries, 39 percent of students had teachers with a low level of confidence, and in two of the highest-performing comparator countries, Japan and Korea, more than half the students had teachers who felt only somewhat prepared or less. In the United States, science teachers generally reported greater confidence in their preparation than did their peers in other countries, with only the Czech Republic reporting greater confidence among the comparator countries. Despite this, however, teachers in the U.S. overall and in many Benchmarking entities generally expressed much less confidence in their preparation to teach eighth-grade science than mathematics. The full Benchmarking reports (see footnote 3 earlier) contain detailed exhibits which examine teacher responses to each item used to create these indices. We encourage the reader to explore those data for further information.

Index Description

Index based on mathematics teachers' responses to 12 questions about how prepared they feel to teach different mathematics topics based on a 3-point scale: 1 = not well prepared; 2 = somewhat prepared; 3 = very well prepared. Average is computed across the 12 items for items for which the teacher did not respond do not teach. High level indicates average is greater than or equal to 2.75. Medium level indicates average is greater than or equal to 2.25 and less than 2.75. Low level indicates average is less than 2.25.

| | High Confidence (CPTM) | | Medium Confidence (CPTM) | | Low Confidence (CPTM) | |
|---------------------------------|------------------------|---------------------|--------------------------|---------------------|-----------------------|---------------------|
| | Percent of Students | Average Achievement | Percent of Students | Average Achievement | Percent of Students | Average Achievement |
| International Average | 63 (0.6) | 489 (1.1) | 23 (0.6) | 481 (1.7) | 14 (0.5) | 473 (2.9) |
| United States | 87 (2.4) | 505 (4.2) | 11 (2.3) | 489 (7.0) | 2 (1.0) | ~ ~ |
| <i>Pennsylvania</i> | 92 (5.0) | 512 (7.2) | 4 (1.7) | 496 (27.7) | 5 (4.7) | 501 (6.7) |
| Southwest Pennsylvania | 94 (3.4) | 519 (8.1) | 5 (3.4) | 508 (20.0) | 1 (0.0) | ~ ~ |
| Australia | 77 (4.1) | 529 (5.7) | 16 (3.4) | 521 (9.8) | 6 (2.3) | 502 (23.9) |
| Canada | 71 (2.7) | 537 (3.3) | 21 (3.0) | 530 (6.6) | 8 (1.8) | 515 (14.6) |
| Chinese Taipei | 71 (3.6) | 586 (4.5) | 15 (3.1) | 587 (10.9) | 14 (2.7) | 572 (6.8) |
| Czech Republic | 85 (3.6) | 521 (5.1) | 14 (3.8) | 519 (9.5) | 1 (1.3) | ~ ~ |
| England | -- | -- | -- | -- | -- | -- |
| First in the World Consort., IL | 93 (5.5) | 564 (6.4) | 7 (5.5) | 491 (11.8) | 0 (0.0) | ~ ~ |
| Japan | 8 (2.1) | 584 (6.1) | 24 (3.6) | 589 (4.2) | 68 (4.0) | 573 (2.6) |
| Korea, Rep. of | 48 (3.9) | 585 (3.2) | 31 (3.8) | 590 (4.1) | 21 (3.0) | 588 (3.5) |
| Michigan | 91 (3.3) | 525 (6.9) | 8 (3.3) | 479 (17.0) | 1 (0.6) | ~ ~ |
| Michigan Invitational Group, MI | 94 (2.1) | 530 (5.0) | 6 (2.1) | 519 (27.2) | 0 (0.0) | ~ ~ |
| Naperville Sch. Dist. #203, IL | 95 (1.9) | 570 (3.0) | 5 (1.9) | 529 (8.9) | 0 (0.0) | ~ ~ |
| Netherlands | 81 (6.2) | 542 (7.1) | 10 (3.0) | 514 (22.4) | 9 (5.8) | 514 (58.7) |
| Project SMART Consortium, OH | 90 (4.1) | 526 (8.1) | 10 (4.1) | 476 (16.7) | 0 (0.0) | ~ ~ |
| Singapore | 66 (4.2) | 603 (7.1) | 24 (3.7) | 619 (12.0) | 10 (2.8) | 578 (20.8) |

States in italics did not fully satisfy guidelines for sample participation rates (see Appendix A).

A dash (-) indicates data are not available. A tilde (~) indicates insufficient data to report achievement.

() Standard errors appear in parentheses. Because results are rounded to the nearest whole number, some totals may appear inconsistent.

SOURCE: IEA Third International Mathematics and Science Study (TIMSS) 1998-1999

Index Description

Index based on science teachers' responses to 10 questions about how prepared they feel to teach different science topics based on a 3-point scale: 1 = not well prepared; 2 = somewhat prepared; 3 = very well prepared. Average is computed across the 10 items for items for which the teacher did not respond do not teach. High level indicates average is greater than or equal to 2.75. Medium level indicates average is greater than or equal to 2.25 and less than 2.75. Low level indicates average is less than 2.25.

| | High Confidence (CPTS) | | Medium Confidence (CPTS) | | Low Confidence (CPTS) | |
|---------------------------------|------------------------|---------------------|--------------------------|---------------------|-----------------------|---------------------|
| | Percent of Students | Average Achievement | Percent of Students | Average Achievement | Percent of Students | Average Achievement |
| International Average | 20 (0.5) | 487 (1.7) | 41 (0.6) | 485 (1.1) | 39 (0.6) | 477 (1.2) |
| United States <i>r</i> | 27 (3.0) | 526 (8.7) | 55 (3.5) | 519 (5.8) | 18 (2.5) | 511 (9.2) |
| <i>Pennsylvania</i> | 23 (4.9) | 542 (7.9) | 49 (6.0) | 517 (6.5) | 28 (5.6) | 547 (12.4) |
| Southwest Pennsylvania | 26 (4.4) | 550 (9.7) | 50 (5.8) | 541 (9.6) | 25 (6.5) | 541 (15.5) |
| Australia | 22 (2.9) | 548 (8.5) | 56 (3.5) | 540 (5.7) | 22 (3.1) | 535 (6.4) |
| Canada <i>r</i> | 16 (2.4) | 542 (5.3) | 47 (3.2) | 534 (3.6) | 37 (2.8) | 533 (4.6) |
| Chinese Taipei | 14 (3.0) | 573 (7.9) | 46 (4.8) | 576 (5.9) | 40 (4.5) | 559 (6.3) |
| Czech Republic | 40 (2.8) | 538 (4.8) | 46 (2.8) | 544 (5.8) | 15 (2.4) | 533 (6.2) |
| England | -- | -- | -- | -- | -- | -- |
| First in the World Consort., IL | 33 (6.1) | 575 (14.3) | 66 (6.2) | 560 (5.6) | 1 (0.1) | ~ ~ |
| Japan | 3 (1.5) | 564 (7.3) | 15 (3.1) | 548 (6.0) | 82 (3.1) | 549 (2.6) |
| Korea, Rep. of | 6 (1.8) | 543 (8.8) | 32 (3.3) | 552 (3.8) | 62 (3.5) | 548 (3.3) |
| Michigan | 26 (5.6) | 558 (8.0) | 58 (5.7) | 554 (10.6) | 16 (4.1) | 562 (8.7) |
| Michigan Invitational Group, MI | 38 (3.7) | 562 (4.8) | 46 (6.3) | 563 (9.2) | 16 (4.8) | 574 (12.5) |
| Naperville Sch. Dist. #203, IL | 34 (4.9) | 586 (5.2) | 59 (5.1) | 583 (6.1) | 7 (1.6) | 575 (8.7) |
| Netherlands | 19 (2.9) | 550 (10.4) | 45 (3.8) | 545 (10.2) | 35 (3.5) | 543 (7.4) |
| Project SMART Consortium, OH | 42 (3.6) | 538 (12.4) | 46 (4.6) | 541 (13.6) | 12 (4.1) | 520 (9.1) |
| Singapore | 18 (3.3) | 568 (14.4) | 44 (4.1) | 576 (10.4) | 38 (4.4) | 559 (13.1) |

States in italics did not fully satisfy guidelines for sample participation rates (see Appendix A).

() Standard errors appear in parentheses. Because results are rounded to the nearest whole number, some totals may appear inconsistent.

A dash (-) indicates data are not available. A tilde (~) indicates insufficient data to report achievement.

An "r" indicates teacher response data available for 70-84% of students.

SOURCE: IEA Third International Mathematics and Science Study (TIMSS) 1998-1999

Selected Teaching Strategies in Mathematics and Science

In addition to detailed information about teachers preparation and confidence, the Benchmarking reports include detailed data regarding teacher and student activity in mathematics and science classes. Rather than replicate many of the exhibits from those reports, we encourage you to review them as companion pieces to this report, especially so in this chapter. We have brought a number of interesting exhibits into this report and reconfigured them to display data from the comparator countries and jurisdictions as a way of highlighting a few variables in the complexity that represents the teaching/learning interaction. They include: indices of teaching emphasis on reasoning and problem-solving, use of experiments in science, calculator use and emphasis in mathematics, various pedagogical strategies used in classes, and the role of homework.

The Role of Reasoning and Problem-Solving

Educators, parents, employers, and most of the public support the goal of improving students' capacity for mathematics problem-solving. To examine the emphasis placed on that goal, TIMSS created an index of teachers' emphasis on mathematics reasoning and problem-solving (EMRPS). As shown in Exhibit 5.5, the index is based on teachers' responses about how often they asked students to explain the reasoning behind an idea, represent and analyze relationships using tables, charts, or graphs, work on problems for which there was no immediate solution, and write equations to represent relationships. Students were placed in the high category if, on average, they were asked to do these activities in most of their lessons. The medium level represents students asked to do these activities in some to most lessons, and students in the low category did them only in some lessons or rarely.

Nearly half the Japanese students were at the high index level, compared with the international average of 15 percent. Across countries, most students (61 percent on average) were in the medium category. An emphasis on problem-solving was related to performance, with students at the high and medium levels having higher average achievement than those at the low level, both internationally and for most entities, including Southwest Pennsylvania. There was tremendous variation among the Benchmarking participants on this index.

Index Description

Index based on mathematics teachers' responses to four questions about how often they ask students to: 1) explain the reasoning behind an idea; 2) represent and analyze relationships using tables, charts, or graphs; 3) work on problems for which there is no immediately obvious method of solution; 4) write equations to represent relationships. Average is computed across the four items based on a 4-point scale: 1 = never or almost never; 2 = some lessons; 3 = most lessons; 4 = every lesson. High level indicates average is greater than or equal to 3. Medium level indicates average is greater than or equal to 2.25 and less than 3. Low level indicates average is less than 2.25.

| | High Emphasis (EMRPS) | | Medium Emphasis (EMRPS) | | Low Emphasis (EMRPS) | |
|---------------------------------|-----------------------|---------------------|-------------------------|---------------------|----------------------|---------------------|
| | Percent of Students | Average Achievement | Percent of Students | Average Achievement | Percent of Students | Average Achievement |
| International Average | 15 (0.5) | 493 (3.5) | 61 (0.7) | 490 (1.0) | 24 (0.6) | 479 (1.5) |
| United States | 18 (2.5) | 519 (12.4) | 57 (2.9) | 502 (4.1) | 24 (2.7) | 489 (6.4) |
| <i>Pennsylvania</i> | 10 (3.3) | 512 (21.2) | 67 (5.4) | 518 (9.0) | 22 (5.8) | 489 (9.2) |
| Southwest Pennsylvania | 17 (4.9) | 517 (19.0) | 62 (6.0) | 527 (10.6) | 21 (5.7) | 492 (8.4) |
| Australia | 7 (2.1) | 532 (9.1) | 54 (4.5) | 538 (6.8) | 39 (4.3) | 508 (7.0) |
| Canada | 13 (2.0) | 550 (8.1) | 62 (3.4) | 537 (3.5) | 26 (3.0) | 518 (4.9) |
| Chinese Taipei | 13 (2.4) | 571 (7.5) | 58 (4.2) | 594 (6.0) | 29 (3.8) | 573 (6.9) |
| Czech Republic | 21 (4.2) | 539 (8.4) | 73 (4.6) | 516 (5.6) | 6 (2.6) | 502 (10.3) |
| England ^s | 3 (1.4) | 533 (24.8) | 66 (3.5) | 519 (7.2) | 31 (3.4) | 490 (7.6) |
| First in the World Consort., IL | 42 (8.8) | 536 (8.1) | 54 (8.8) | 581 (10.4) | 4 (3.0) | 492 (12.6) |
| Japan | 49 (4.1) | 584 (2.6) | 45 (4.1) | 574 (2.5) | 7 (2.1) | 562 (6.2) |
| Korea, Rep. of | 21 (3.0) | 588 (4.0) | 66 (3.3) | 586 (2.6) | 13 (2.4) | 594 (4.6) |
| Michigan | 21 (4.7) | 558 (16.9) | 60 (5.2) | 516 (7.6) | 19 (4.8) | 510 (11.8) |
| Michigan Invitational Group, MI | 41 (9.6) | 521 (5.0) | 52 (10.2) | 549 (9.4) | 7 (3.5) | 484 (17.2) |
| Naperville Sch. Dist. #203, IL | 29 (4.9) | 569 (9.9) | 67 (4.8) | 571 (5.1) | 4 (2.6) | 524 (15.0) |
| Netherlands | 12 (3.5) | 561 (12.7) | 60 (6.1) | 528 (10.3) | 28 (5.2) | 547 (9.5) |
| Project SMART Consortium, OH | 13 (2.0) | 540 (13.6) | 60 (5.8) | 516 (10.2) | 27 (5.6) | 522 (16.6) |
| Singapore | 7 (2.1) | 617 (25.9) | 47 (4.0) | 607 (8.8) | 47 (4.4) | 599 (8.2) |

States in italics did not fully satisfy guidelines for sample participation rates (see Appendix A).

() Standard errors appear in parentheses. Because results are rounded to the nearest whole number, some totals may appear inconsistent.

An "s" indicates teacher response data available for 50-69% of students.

SOURCE: IEA Third International Mathematics and Science Study (TIMSS) 1998-1999

Effective science instruction requires the teacher to guide, focus, challenge, and encourage student learning. Problem-solving activities typically call upon students to use higher-order think-

ing skills. Similar to the index created for mathematics, TIMSS created an index of teachers' emphasis on scientific reasoning and problem-solving (ESRPS), shown in Exhibit 5.6.

Index Description

Index based on science teachers' responses to five questions about how often they ask students to: 1) explain the reasoning behind an idea; 2) represent and analyze relationships using tables, charts, graphs; 3) work on problems for which there is no immediately obvious method of solution; 4) write explanations about what was observed and why it happened; 5) put events or objects in order and give a reason for the organization. Average is computed across the five items based on a 4-point scale: 1 = never or almost never; 2 = some lessons; 3 = most lessons; 4 = every lesson. High level indicates average is greater than or equal to 3. Medium level indicates average is greater than or equal to 2.25 and less than 3. Low level indicates average is less than 2.25.

| | High Emphasis (ESRPS) | | Medium Emphasis (ESRPS) | | Low Emphasis (ESRPS) | |
|---------------------------------------|-----------------------|---------------------|-------------------------|---------------------|----------------------|---------------------|
| | Percent of Students | Average Achievement | Percent of Students | Average Achievement | Percent of Students | Average Achievement |
| International Average | 16 (0.4) | 490 (1.9) | 44 (0.6) | 488 (1.2) | 40 (0.6) | 482 (1.1) |
| United States <i>r</i> | 16 (2.3) | 519 (9.7) | 51 (3.2) | 524 (6.3) | 33 (3.7) | 514 (6.5) |
| <i>Pennsylvania</i> | 15 (6.5) | 543 (14.9) | 43 (5.3) | 534 (5.3) | 43 (8.3) | 518 (10.0) |
| Southwest Pennsylvania | 14 (4.2) | 533 (11.5) | 45 (8.5) | 546 (9.4) | 41 (9.2) | 546 (14.3) |
| Australia | 11 (2.3) | 524 (11.1) | 38 (3.5) | 541 (5.4) | 51 (3.3) | 541 (6.7) |
| Canada <i>r</i> | 26 (3.1) | 551 (5.5) | 48 (3.4) | 530 (4.4) | 26 (2.7) | 528 (5.7) |
| Chinese Taipei | 11 (2.5) | 589 (13.5) | 34 (4.3) | 576 (7.4) | 54 (4.4) | 559 (4.9) |
| Czech Republic | 9 (1.7) | 543 (8.2) | 42 (3.1) | 543 (6.1) | 48 (3.4) | 537 (4.5) |
| England <i>s</i> | 7 (2.3) | 541 (28.3) | 41 (4.6) | 557 (7.5) | 51 (4.7) | 540 (8.0) |
| First in the World Consort., IL | 29 (6.2) | 553 (11.5) | 46 (7.5) | 576 (9.4) | 25 (2.7) | 556 (6.1) |
| Japan | 32 (4.0) | 555 (3.1) | 37 (4.4) | 549 (3.5) | 31 (3.9) | 545 (3.7) |
| Korea, Rep. of | 6 (1.9) | 541 (10.4) | 48 (4.1) | 552 (3.3) | 46 (3.9) | 547 (3.2) |
| Michigan <i>r</i> | 17 (5.2) | 531 (12.4) | 46 (6.5) | 562 (9.2) | 37 (5.0) | 556 (8.6) |
| Michigan Invitational Group, MI | 7 (0.7) | 513 (6.7) | 46 (4.3) | 565 (8.2) | 46 (4.6) | 572 (7.5) |
| Naperville Sch. Dist. #203, IL | 63 (4.1) | 578 (5.1) | 31 (4.1) | 592 (9.1) | 6 (0.7) | 615 (14.8) |
| Netherlands | 5 (1.4) | 570 (13.1) | 35 (4.3) | 559 (6.9) | 60 (4.6) | 536 (10.1) |
| Project SMART Consortium, OH <i>r</i> | 17 (2.9) | 522 (15.7) | 35 (4.0) | 529 (14.7) | 47 (4.2) | 549 (13.0) |
| Singapore | 8 (2.4) | 600 (20.7) | 29 (3.8) | 579 (15.8) | 63 (4.2) | 559 (10.0) |

States in italics did not fully satisfy guidelines for sample participation rates (see Appendix A).

An "r" indicates teacher response data available for 70-84% of students. An "s" indicates teacher response data available for 50-69% of students.

() Standard errors appear in parentheses. Because results are rounded to the nearest whole number, some totals may appear inconsistent.

SOURCE: IEA Third International Mathematics and Science Study (TIMSS) 1998-1999

On average internationally, 16 percent of students had teachers who placed a high emphasis on scientific reasoning and problem-solving, ranging from five percent in the Netherlands to about one-third in Japan among the comparator countries.

While the emphasis on scientific reasoning and problem-solving was associated with achievement in some countries, there was no strong or consistent relationship internationally or across entities. There was tremendous variation among the

Benchmarking participants on this index, ranging from 63 percent of students in the high category in Naperville to seven percent in the Michigan Invitational Group. Southwest Pennsylvania reported 14 percent in the high category, 45 percent in the medium, and 41 percent in the low category, with no difference in performance between the medium and low categories.

The Use of Experiments in Science

The choices teachers make determine, to a large extent, what students learn. An important aspect of teaching science is the emphasis placed on scientific investigation. In order to measure this, TIMSS created an index of emphasis on conducting experiments in science classes (ECES), shown in Exhibit 5.7. The index is based on students' and teachers' reports of the frequency of the teacher demonstrating experiments and the students conducting experiments or practical investigations. A high level indicates that the teacher reported that at least 25 percent of class time is spent on the teacher demonstrating or students conducting experiments, and the student reported that these occur almost always or pretty often. A low level indicates that the teacher reported that 10 percent or less of class time is spent on the teacher demonstrating or students conducting experiments, and the student reported that these occur once in a while or never. The middle category includes all other combinations of responses.

Internationally on average, 38 percent of students in countries and jurisdictions with general/integrated science were in classes with a high emphasis on experiments, ranging in the

comparator group from 14 percent in Chinese Taipei to 79 percent in Naperville. Southwest Pennsylvania closely mirrored the international average, with 39 percent of students in classes with a high emphasis, 57 percent in the medium category, and only four percent in the low category. Generally, in most jurisdictions and countries, including Southwest Pennsylvania, students who scored higher were taught in classes where teachers reported more emphasis on experiments.

The data reported here only reveal patterns in the *frequency* of experiment use in science and do not illustrate *how* teachers are incorporating experiments in the curriculum to enhance student learning. As is true with any instructional technique, frequency of use is only one indicator.

Index Description

Index based on science teachers' reports on the percentage of time they spend demonstrating experiments; teachers' reports on the percentage of time students spend conducting experiments; students' reports on how often the teacher gives a demonstration of an experiment in science lessons; students' reports on how often they conduct an experiment or practical investigation in class. High level indicates the teacher reported that at least 25 percent of class time is spent on the teacher demonstrating experiments or students conducting experiments, and the student reported that the teacher gives a demonstration of an experiment or the student conducts an experiment or practical investigation in class almost always or pretty often. Low level indicates the teacher reported that less than 10 percent of class time is spent on the teacher demonstrating experiments or students conducting experiments, and the student reported that the teacher gives a demonstration of an experiment and the student conducts an experiment or practical investigation in class once in a while or never. Medium level includes all other combinations of responses.

| | High Emphasis (ECES) | | Medium Emphasis (ECES) | | Low Emphasis (ECES) | |
|--|----------------------|---------------------|------------------------|---------------------|---------------------|---------------------|
| | Percent of Students | Average Achievement | Percent of Students | Average Achievement | Percent of Students | Average Achievement |
| International Average ¹ | 38 (0.7) | 483 (1.7) | 59 (0.7) | 478 (1.3) | 3 (0.2) | 459 (5.3) |
| United States <i>r</i> | 31 (2.6) | 531 (6.8) | 64 (2.6) | 523 (5.3) | 4 (1.1) | 529 (7.5) |
| <i>Pennsylvania r</i> | 33 (6.8) | 549 (8.9) | 60 (4.4) | 528 (7.8) | 7 (4.1) | 491 (12.2) |
| Southwest Pennsylvania | 39 (6.9) | 559 (6.8) | 57 (6.3) | 539 (11.0) | 4 (2.9) | 511 (20.7) |
| Australia | 45 (3.9) | 544 (6.1) | 54 (3.9) | 536 (5.3) | 1 (0.3) | ~ ~ |
| Canada <i>r</i> | 47 (3.8) | 539 (4.1) | 52 (3.9) | 533 (3.6) | 1 (0.5) | ~ ~ |
| Chinese Taipei ² | 14 (2.8) | 574 (9.2) | 84 (2.9) | 570 (4.9) | 2 (0.6) | ~ ~ |
| Czech Republic ³ | -- | -- | -- | -- | -- | -- |
| England <i>s</i> | 59 (4.9) | 556 (7.9) | 40 (4.9) | 539 (8.0) | 0 (0.0) | ~ ~ |
| First in the World Consort., IL | 56 (6.9) | 573 (6.0) | 44 (6.9) | 555 (8.0) | 0 (0.0) | ~ ~ |
| Japan | 54 (4.0) | 552 (3.2) | 45 (3.8) | 549 (2.6) | 1 (0.6) | ~ ~ |
| Korea, Rep. of | 27 (3.1) | 558 (3.4) | 71 (3.0) | 546 (3.0) | 2 (0.7) | ~ ~ |
| Michigan <i>r</i> | 44 (6.0) | 566 (5.6) | 54 (6.1) | 548 (10.1) | 2 (1.6) | ~ ~ |
| Michigan Invitational Group, MI <i>r</i> | 22 (2.8) | 577 (20.5) | 78 (2.8) | 564 (4.5) | 0 (0.0) | ~ ~ |
| Naperville Sch. Dist. #203, IL | 79 (3.8) | 584 (5.3) | 21 (3.8) | 592 (11.8) | 0 (0.0) | ~ ~ |
| Netherlands ³ | -- | -- | -- | -- | -- | -- |
| Project SMART Consortium, OH <i>r</i> | 43 (3.5) | 544 (11.8) | 57 (3.5) | 535 (10.9) | 0 (0.0) | ~ ~ |
| Singapore | 55 (4.1) | 580 (10.0) | 44 (4.0) | 556 (12.7) | 1 (0.6) | ~ ~ |

1 International average is for countries where science is taught as a single general/integrated science course at grade 8.

2 Students were asked about 'natural science'; data pertain to a grade 8 physics/chemistry course.

3 Data are not available for these countries where science is taught as separate courses at grade 8.

States in italics did not fully satisfy guidelines for sample participation rates (see Appendix A).

() Standard errors appear in parentheses. Because results are rounded to the nearest whole number, some totals may appear inconsistent.

A tilde (~) indicates insufficient data to report achievement.

An "r" indicates teacher and/or student response data available for 70-84% of students. An "s" indicates teacher and/or student response data available for 50-69% of students.

SOURCE: IEA Third International Mathematics and Science Study (TIMSS) 1998-1999

The Use of Calculators in Mathematics

Exhibit 5.8 shows data on students' *access* to calculators for use in mathematics class and on *policies on their use* for those with access. When all 38 TIMSS 1999 countries were considered, teachers in 14 countries reported that nearly all students (more than 90 percent) had access to calculators in class. In addition to the United States, the countries with this high degree of access were Australia, Belgium (Flemish), Canada, the Czech Republic, England, Finland, Hong Kong, Israel, Lithuania, the Netherlands, New Zealand, Singapore, and the Slovak Republic. For students in classes with access to calculators, most teachers reported some type of restricted use (for about two-thirds of the students on average internationally). Corresponding to the results for the United States, most students in the Benchmarking entities (83 to 100 percent) had access to calculators. The policies regarding use varied dramatically, however. Whereas use was restricted for only about one-third of the students in some comparator jurisdictions – the First in the World Consortium and the Michigan Invitational Group – as many as two-thirds or more of the students were subject to some restrictions in Pennsylvania and Project SMART, as well as in the U.S. Southwest Pennsylvania reported that all students had access to calculators and slightly more than half had restricted use of them. Interestingly, while the international average shows little difference in achievement between students with unrestricted versus restricted use, among the comparator group, including Southwest Pennsylvania, there is a fairly strong and consistent relationship between unrestricted use and higher achievement.

TIMSS combined students' and teachers' reports on the frequency of calculator use to create an index of emphasis on calculators in mathematics class (ECMC). These data are presented in Exhibit 5.9. Students were placed in the high category if they reported using calculators in class almost always or pretty often and their teachers reported calculator use of at least once or twice a week. At the other end of the spectrum, students were placed in the low category if they reported using calculators only once in a while or never and their teachers reported asking students to use calculators never or hardly ever. There was enormous variation in the results across countries. For example, the Netherlands and Singapore had more than four-fifths of their students (95 and 85 percent, respectively) in the high category. In contrast, a number of countries had half or more of their students in the low category, including Chinese Taipei, Korea, and Japan. Since several high-performing countries have restricted calculator use and large percentages of students are in the low-use category, the relationship between calculator use and performance is difficult to interpret. Although on average internationally the relationship is unclear, in most of the countries where emphasis on calculator use was high, there was a positive association between calculator use and mathematics achievement. This relationship was true for Southwest Pennsylvania as well. The region reported 70 percent of students in the high emphasis category and a 29-point difference in average achievement between high and medium emphasis categories.

| | Percentage of Students Having Access to Calculators in Class | Policy on Use of Calculators During Mathematics Lessons for Students Having Access | | | | | |
|---------------------------------|--|--|---------------------|---------------------|---------------------|---------------------------|---------------------|
| | | Unrestricted Use | | Restricted Use | | Calculators Not Permitted | |
| | | Percent of Students | Average Achievement | Percent of Students | Average Achievement | Percent of Students | Average Achievement |
| International Average | 73 (0.5) | 21 (0.5) | 490 (2.2) | 67 (0.7) | 488 (1.2) | 12 (0.6) | 464 (3.5) |
| United States | 96 (1.2) | 34 (3.3) | 524 (6.7) | 66 (3.3) | 493 (4.5) | 0 (0.2) | ~ ~ |
| <i>Pennsylvania</i> | 89 (5.9) | 32 (4.6) | 554 (9.9) | 66 (4.8) | 495 (8.0) | 2 (0.2) | ~ ~ |
| Southwest Pennsylvania | 100 (0.0) | 45 (7.1) | 541 (9.8) | 55 (7.1) | 498 (10.7) | 0 (0.0) | ~ ~ |
| Australia | 94 (2.2) | 63 (4.3) | 531 (6.3) | 37 (4.3) | 523 (9.4) | 0 (0.0) | ~ ~ |
| Canada | 96 (1.1) | 40 (3.3) | 537 (4.5) | 60 (3.3) | 531 (4.5) | 0 (0.0) | ~ ~ |
| Chinese Taipei | 51 (4.6) | 13 (3.9) | 576 (13.0) | 85 (4.3) | 577 (5.7) | 3 (2.0) | 599 (76.8) |
| Czech Republic | 94 (2.4) | 7 (2.7) | 517 (13.4) | 91 (3.1) | 522 (4.7) | 2 (1.5) | ~ ~ |
| England | 100 (0.3) | 14 (2.2) | 547 (16.0) | 86 (2.2) | 504 (5.2) | 0 (0.0) | ~ ~ |
| First in the World Consort., IL | 100 (0.0) | 65 (4.7) | 569 (6.6) | 35 (4.7) | 538 (8.9) | 0 (0.0) | ~ ~ |
| Japan | 34 (4.3) | 13 (3.9) | 579 (5.4) | 85 (4.4) | 579 (5.1) | 2 (0.2) | ~ ~ |
| Korea, Rep. of | 28 (3.4) | 5 (3.3) | 601 (9.0) | 77 (6.3) | 589 (4.6) | 18 (5.7) | 586 (9.0) |
| Michigan | 99 (0.7) | 55 (6.3) | 530 (7.3) | 45 (6.3) | 517 (11.2) | 0 (0.0) | ~ ~ |
| Michigan Invitational Group, MI | 98 (1.7) | 68 (6.5) | 535 (6.7) | 32 (6.5) | 533 (7.5) | 0 (0.0) | ~ ~ |
| Naperville Sch. Dist. #203, IL | 100 (0.0) | 60 (3.1) | 572 (5.2) | 40 (3.1) | 563 (6.7) | 0 (0.0) | ~ ~ |
| Netherlands | 100 (0.0) | 85 (4.1) | 540 (7.8) | 15 (4.1) | 522 (18.5) | 0 (0.0) | ~ ~ |
| Project SMART Consortium, OH | 88 (4.8) | 25 (5.6) | 567 (21.0) | 70 (6.3) | 517 (8.6) | 5 (3.3) | 478 (10.1) |
| Singapore | 100 (0.0) | 31 (4.7) | 622 (11.0) | 69 (4.7) | 597 (6.2) | 0 (0.0) | ~ ~ |

Background data provided by teachers.

* The use of calculators on TIMSS was not allowed in 1995 or in 1999.

States in italics did not fully satisfy guidelines for sample participation rates (see Appendix A).

() Standard errors appear in parentheses. Because results are rounded to the nearest whole number, some totals may appear inconsistent.

A tilde (~) indicates insufficient data to report achievement.

An "s" indicates teacher response data available for 50-69% of students.

The data shown here report the frequency of use and policies related to restricted and unrestricted use of calculators. The data do not provide insight into *how* teachers are using calculators pedagogically. The use of calculators in various ways to enhance instruction and learning generates issues of continued deliberation among mathematics educators.

Index Description

Index based on students' reports of the frequency of using calculators in mathematics lessons and mathematics teachers' reports of students' use of calculators in mathematics class for five activities: checking answers; tests and exams; routine computation; solving complex problems; and exploring number concepts. High level indicates the student reported using calculators in mathematics lessons always or pretty often, and the teacher reported students use calculators at least once or twice a week for any of the tasks. Low level indicates the student reported using calculators once in a while or never, and the teacher reported students use calculators never or hardly ever for all of the tasks. Medium level includes all other combinations of responses.

| | High Emphasis (ECMC) | | Medium Emphasis (ECMC) | | Low Emphasis (ECMC) | |
|---------------------------------|----------------------|---------------------|------------------------|---------------------|---------------------|---------------------|
| | Percent of Students | Average Achievement | Percent of Students | Average Achievement | Percent of Students | Average Achievement |
| International Average | 32 (0.3) | 481 (1.8) | 42 (0.5) | 484 (1.2) | 26 (0.5) | 481 (3.3) |
| United States <i>r</i> | 65 (3.2) | 515 (4.5) | 31 (2.9) | 489 (6.4) | 5 (1.2) | 476 (10.8) |
| <i>Pennsylvania</i> | 63 (6.1) | 521 (8.3) | 25 (3.6) | 497 (8.5) | 12 (5.7) | 492 (8.5) |
| Southwest Pennsylvania | 70 (5.4) | 528 (7.6) | 29 (5.1) | 499 (11.1) | 1 (0.7) | ~ ~ |
| Australia | 84 (2.4) | 531 (5.5) | 12 (1.8) | 515 (12.9) | 4 (1.6) | 484 (24.7) |
| Canada <i>r</i> | 79 (1.9) | 537 (3.0) | 18 (1.7) | 523 (4.7) | 3 (0.9) | 548 (6.8) |
| Chinese Taipei | 2 (0.4) | ~ ~ | 48 (4.0) | 576 (4.8) | 50 (4.2) | 598 (5.4) |
| Czech Republic | 35 (3.2) | 528 (7.1) | 60 (3.5) | 517 (4.7) | 5 (2.0) | 507 (26.2) |
| England <i>s</i> | 80 (2.3) | 524 (5.7) | 19 (2.2) | 462 (6.5) | 1 (0.7) | ~ ~ |
| First in the World Consort., IL | 86 (2.4) | 560 (5.8) | 14 (2.4) | 547 (17.7) | 0 (0.0) | ~ ~ |
| Japan | 0 (0.1) | ~ ~ | 21 (3.2) | 573 (6.4) | 79 (3.2) | 579 (2.2) |
| Korea, Rep. of | 0 (0.3) | ~ ~ | 29 (3.3) | 587 (4.0) | 71 (3.3) | 587 (2.4) |
| Michigan | 78 (3.3) | 530 (6.8) | 21 (3.1) | 507 (7.6) | 1 (0.9) | ~ ~ |
| Michigan Invitational Group, MI | 90 (3.2) | 536 (5.0) | 9 (2.8) | 506 (8.8) | 2 (0.1) | ~ ~ |
| Naperville Sch. Dist. #203, IL | 92 (0.8) | 570 (2.8) | 8 (0.8) | 549 (14.2) | 0 (0.0) | ~ ~ |
| Netherlands | 95 (1.1) | 538 (7.2) | 5 (1.1) | 512 (23.5) | 0 (0.0) | ~ ~ |
| Project SMART Consortium, OH | 50 (2.9) | 545 (11.6) | 39 (4.3) | 502 (8.3) | 10 (3.5) | 483 (8.9) |
| Singapore | 85 (1.6) | 611 (6.3) | 15 (1.6) | 567 (7.1) | 0 (0.0) | ~ ~ |

* The use of calculators on TIMSS was not allowed in 1995 or in 1999. States in italics did not fully satisfy guidelines for sample participation rates (see Appendix A).
() Standard errors appear in parentheses. Because results are rounded to the nearest whole number, some totals may appear inconsistent.

A tilde (~) indicates insufficient data to report achievement. An "r" indicates teacher and/or student response data available for 70-84% of students. An "s" indicates teacher and/or student response data available for 50-69% of students.

SOURCE: IEA Third International Mathematics and Science Study (TIMSS) 1998-1999

The Role of Homework in Mathematics and Science

The amount of time students spend on homework assignments is an important consideration in examining their opportunity to learn mathematics and science. To examine this aspect of teaching, data were gathered to form indices of teachers' emphasis on mathematics and science homework. Further, the use of homework as an in-class instructional tool is also explored as a way of better understanding the role of homework in mathematics and science classes.

Exhibit 5.10 presents the index of teachers' emphasis on mathematics homework (EMH). Students in the high category had teachers who reported giving relatively long homework assignments (more than 30 minutes) on a relatively frequent basis (at least once or twice a week). Those in the low category had teachers who gave short assignments (less than 30 minutes) relatively infrequently (less than once a week or never). The medium level includes all other combinations of responses.

The results show substantial variation across countries and Benchmarking entities in the emphasis placed on homework. Singapore was the only comparator country or jurisdiction with more than half its students in the high category. For the Benchmarking comparator jurisdictions, the majority of students were in the medium category. Very few students were in the low category. One notable exception is Japan (34 percent in the low category), where students were more likely to spend extra time in tutoring and special schools than doing homework.⁴ There was little relationship between the amount of homework assigned

and students' performance, though Southwest Pennsylvania reported a fairly substantial difference of 51 points favoring students doing more homework. The data related to homework and achievement may be skewed in that lower-performing students may need more homework assignments for remedial reasons.

Exhibit 5.11 examines a variety of activities used in mathematics classes, including reviewing completed homework and beginning newly assigned homework. Unlike international and high-achieving counterparts, U.S. mathematics teachers, and Southwest Pennsylvania teachers to a somewhat greater degree, tend to both review and begin new homework as instructional strategies. Compared with the international average of 55 percent, 85 percent of students in Southwest Pennsylvania reported discussing completed homework in class. The range across the comparator group varied widely, from 10 percent in Korea to 91 percent in First in the World and Naperville. Likewise, 79 percent of Southwest Pennsylvania students reported beginning homework in class, compared with the international average of 42 percent. Again, this varied considerably across comparator entities from a low of 16 percent in the Czech Republic to a high of 89 percent in the Netherlands.

Exhibit 5.12 presents the index of teachers' emphasis on science homework (ESH). As in mathematics, the results show substantial variation across countries and Benchmarking jurisdictions in the emphasis placed on homework, with the nearly all of the comparator entities and Southwest Pennsylvania having the majority of students in the medium category. Comparator countries with one-third or more of their students in the low cat-

⁴ Robitaille, D.F., (1997). *National Contexts for Mathematics and Science Education: An Encyclopedia of the Education Systems Participating in TIMSS*, Vancouver, BC: Pacific Educational Press.

Index Description

Index based on mathematics teachers' responses to two questions about how often they usually assign mathematics homework and how many minutes of mathematics homework they usually assign students. High level indicates the assignment of more than 30 minutes of homework at least once or twice a week. Low level indicates the assignment of less than 30 minutes of homework less than once a week or never assigning homework. Medium level includes all other combinations of responses.

| | High Emphasis (EMH) | | Medium Emphasis (EMH) | | Low Emphasis (EMH) | |
|---------------------------------|---------------------|---------------------|-----------------------|---------------------|---------------------|---------------------|
| | Percent of Students | Average Achievement | Percent of Students | Average Achievement | Percent of Students | Average Achievement |
| International Average | 35 (0.6) | 491 (1.8) | 62 (0.6) | 485 (1.0) | 4 (0.2) | 484 (4.0) |
| United States | 25 (2.1) | 528 (9.6) | 75 (2.0) | 495 (3.8) | 1 (0.6) | ~ ~ |
| <i>Pennsylvania</i> | 24 (5.2) | 535 (12.6) | 76 (5.2) | 499 (6.3) | 0 (0.0) | ~ ~ |
| Southwest Pennsylvania | 34 (5.3) | 552 (13.5) | 65 (5.3) | 501 (8.8) | 1 (0.9) | ~ ~ |
| Australia | 11 (2.7) | 531 (13.5) | 87 (2.8) | 526 (5.4) | 2 (1.0) | ~ ~ |
| Canada | 16 (2.3) | 527 (6.2) | 83 (2.4) | 532 (2.8) | 1 (0.6) | ~ ~ |
| Chinese Taipei | 48 (3.6) | 593 (6.4) | 50 (3.7) | 580 (5.5) | 2 (1.1) | ~ ~ |
| Czech Republic | 2 (1.2) | ~ ~ | 85 (3.8) | 520 (4.8) | 13 (3.6) | 513 (9.9) |
| England | 28 (2.9) | 529 (8.2) | 71 (3.0) | 485 (4.7) | 1 (0.5) | ~ ~ |
| First in the World Consort., IL | 37 (5.1) | 595 (12.0) | 63 (5.1) | 533 (7.2) | 0 (0.0) | ~ ~ |
| Japan | 11 (2.5) | 578 (3.9) | 55 (4.3) | 580 (2.8) | 34 (4.3) | 574 (5.3) |
| Korea, Rep. of | 25 (3.4) | 587 (4.2) | 62 (3.6) | 586 (2.9) | 14 (2.6) | 593 (4.4) |
| Michigan | 32 (4.3) | 549 (15.0) | 68 (4.3) | 502 (7.0) | 0 (0.0) | ~ ~ |
| Michigan Invitational Group, MI | 28 (6.9) | 570 (14.9) | 72 (6.9) | 517 (5.3) | 0 (0.0) | ~ ~ |
| Naperville Sch. Dist. #203, IL | 29 (2.3) | 588 (3.5) | 68 (2.3) | 559 (4.1) | 2 (0.1) | ~ ~ |
| Netherlands | 11 (2.6) | 555 (14.6) | 88 (2.6) | 538 (8.0) | 1 (0.5) | ~ ~ |
| Project SMART Consortium, OH | 25 (5.7) | 567 (16.1) | 75 (5.7) | 505 (6.8) | 0 (0.0) | ~ ~ |
| Singapore | 66 (4.6) | 613 (6.9) | 34 (4.6) | 587 (10.6) | 0 (0.0) | ~ ~ |

States in italics did not fully satisfy guidelines for sample participation rates (see Appendix A).

() Standard errors appear in parentheses. Because results are rounded to the nearest whole number, some totals may appear inconsistent.

A tilde (~) indicates insufficient data to report achievement.

SOURCE: IEA Third International Mathematics and Science Study (TIMSS) 1998-1999

egory included the Czech Republic, Japan, and Korea. There was little relationship between the amount of homework assigned and students' performance. Again, lower-performing students may need more homework assignments for remedial reasons.

Exhibit 5.13 examines the role of homework and other activities as instructional strategies in science classes. Unlike their mathematics counterparts, science teachers tend to review homework or begin new homework at lesser levels, though still about half of Southwest Pennsylvania students reported they almost always or pretty often

SOURCE: IEA Third International Mathematics and Science Study (TIMSS) 1998–1999

| | Percentage of Students Reporting Almost Always or Pretty Often | | | | |
|---------------------------------|--|---|---|---------------------------------|-----------------------|
| | We Discuss Our Completed Homework | Teacher Shows Us How to Do Mathematics Problems | We Work on Worksheets or Textbooks on Our Own | We Work on Mathematics Projects | We Begin Our Homework |
| International Average | 55 (0.2) | 86 (0.2) | 59 (0.2) | 36 (0.2) | 42 (0.2) |
| United States | 79 (1.2) | 94 (0.6) | 86 (0.7) | 29 (1.3) | 74 (1.6) |
| <i>Pennsylvania</i> | 85 (1.8) | 95 (0.9) | 83 (1.2) | 24 (2.0) | 71 (3.2) |
| Southwest Pennsylvania | 85 (2.1) | 95 (1.0) | 83 (1.9) | 22 (2.2) | 79 (3.3) |
| Australia | 44 (1.8) | 93 (0.7) | 91 (1.2) | 25 (1.7) | 56 (1.6) |
| Canada | 62 (1.4) | 92 (0.5) | 92 (0.5) | 28 (1.1) | 82 (1.2) |
| Chinese Taipei | 55 (1.0) | 91 (0.5) | 59 (1.2) | 55 (1.2) | 34 (1.0) |
| Czech Republic | 42 (1.8) | 86 (1.1) | 51 (2.4) | 8 (0.6) | 16 (1.6) |
| England | 62 (1.5) | 93 (0.7) | 88 (1.5) | 35 (1.4) | 27 (1.6) |
| First in the World Consort., IL | 91 (1.5) | 94 (1.5) | 92 (1.6) | 18 (2.8) | 63 (3.6) |
| Japan | 19 (1.2) | 88 (0.7) | 38 (1.5) | 6 (0.7) | 20 (1.3) |
| Korea, Rep. of | 10 (0.5) | 85 (0.8) | 29 (0.7) | 46 (1.2) | 17 (0.7) |
| Michigan | 84 (1.9) | 95 (0.7) | 89 (0.8) | 28 (2.3) | 83 (2.4) |
| Michigan Invitational Group, MI | 86 (1.3) | 92 (1.2) | 86 (1.7) | 22 (1.3) | 84 (3.0) |
| Naperville Sch. Dist. #203, IL | 91 (0.9) | 96 (0.7) | 92 (0.9) | 15 (1.8) | 87 (1.6) |
| Netherlands | 68 (3.7) | 70 (2.7) | 92 (1.1) | 3 (0.7) | 89 (1.5) |
| Project SMART Consortium, OH | 84 (1.9) | 93 (1.5) | 88 (1.2) | 25 (1.8) | 84 (2.5) |
| Singapore | 61 (1.0) | 97 (0.4) | 75 (0.9) | 15 (1.1) | 60 (1.9) |

Background data provided by teachers.

States in italics did not fully satisfy guidelines for sample participation rates (see Appendix A).

() Standard errors appear in parentheses. Because results are rounded to the nearest whole number, some totals may appear inconsistent.

work with homework as a class activity. These regional data are typically more in line with most other comparator countries and jurisdictions with the exception of some of the higher-achieving countries such as Japan and Korea (which reported equally low percentages on both reviewing and beginning new homework) and Chinese Taipei (which reported a lower percentage on beginning new homework in class).

Index Description

Index based on science teachers' responses to two questions about how often they usually assign science homework and how many minutes of science homework they usually assign students. High level indicates the assignment of more than 30 minutes of homework at least once or twice a week. Low level indicates the assignment of less than 30 minutes of homework less than once a week or never assigning homework. Medium level includes all other combinations of responses.

| | High Emphasis (ESH) | | Medium Emphasis (ESH) | | Low Emphasis (ESH) | |
|---------------------------------|---------------------|---------------------|-----------------------|---------------------|---------------------|---------------------|
| | Percent of Students | Average Achievement | Percent of Students | Average Achievement | Percent of Students | Average Achievement |
| International Average | 19 (0.4) | 484 (2.6) | 62 (0.6) | 486 (1.0) | 18 (0.4) | 485 (2.6) |
| United States | 15 (1.8) | 507 (9.5) | 77 (2.4) | 517 (5.2) | 8 (1.7) | 505 (15.6) |
| <i>Pennsylvania</i> | 15 (4.5) | 531 (16.8) | 76 (5.3) | 531 (6.7) | 9 (3.0) | 496 (19.9) |
| Southwest Pennsylvania | 8 (3.6) | 531 (12.5) | 78 (6.2) | 544 (8.9) | 13 (4.6) | 548 (11.1) |
| Australia | 7 (1.7) | 528 (13.7) | 75 (3.0) | 545 (4.7) | 18 (2.8) | 522 (9.4) |
| Canada | 10 (2.3) | 542 (8.9) | 80 (2.8) | 534 (2.6) | 10 (1.9) | 515 (6.4) |
| Chinese Taipei | 26 (3.8) | 584 (7.8) | 54 (4.4) | 566 (5.5) | 20 (3.3) | 558 (7.9) |
| Czech Republic | 0 (0.3) | ~ ~ | 29 (2.9) | 541 (4.8) | 70 (2.9) | 539 (5.0) |
| England | 22 (2.9) | 563 (11.3) | 74 (3.1) | 533 (5.2) | 4 (1.3) | 511 (12.4) |
| First in the World Consort., IL | 3 (3.3) | 540 (38.9) | 87 (3.5) | 566 (5.7) | 10 (1.2) | 573 (5.3) |
| Japan | 4 (1.7) | 546 (11.0) | 53 (4.1) | 551 (3.0) | 43 (4.2) | 548 (2.9) |
| Korea, Rep. of | 8 (2.2) | 559 (7.9) | 55 (3.9) | 549 (3.3) | 37 (3.8) | 547 (3.4) |
| Michigan | 12 (3.4) | 524 (15.7) | 81 (4.3) | 544 (9.6) | 7 (3.2) | 566 (10.3) |
| Michigan Invitational Group, MI | 25 (2.6) | 567 (19.0) | 75 (2.6) | 563 (5.4) | 0 (0.0) | ~ ~ |
| Naperville Sch. Dist. #203, IL | 17 (2.8) | 594 (9.6) | 83 (2.8) | 583 (4.6) | 0 (0.0) | ~ ~ |
| Netherlands | 5 (1.3) | 573 (9.5) | 82 (3.0) | 548 (6.6) | 13 (3.1) | 514 (11.3) |
| Project SMART Consortium, OH | 19 (2.8) | 568 (16.5) | 70 (2.3) | 534 (9.9) | 12 (2.6) | 510 (13.9) |
| Singapore | 35 (4.3) | 570 (12.3) | 55 (4.1) | 575 (11.2) | 11 (2.4) | 524 (19.3) |

States in italics did not fully satisfy guidelines for sample participation rates (see Appendix A).

() Standard errors appear in parentheses. Because results are rounded to the nearest whole number, some totals may appear inconsistent.

A tilde (~) indicates insufficient data to report achievement.

SOURCE: IEA Third International Mathematics and Science Study (TIMSS) 1998-1999

| | Percentage of Students Reporting Almost Always or Pretty Often | | | | |
|------------------------------------|--|---|---|-----------------------------|-----------------------|
| | We Discuss Our Completed Homework | Teacher Shows Us How to Do Science Problems | We Work on Worksheets or Textbooks on Our Own | We Work on Science Projects | We Begin Our Homework |
| International Average ¹ | 51 (0.3) | 80 (0.2) | 56 (0.3) | 51 (0.3) | 41 (0.3) |
| United States | 63 (1.9) | 69 (1.4) | 76 (1.5) | 59 (1.3) | 57 (2.0) |
| <i>Pennsylvania</i> | 61 (3.1) | 61 (2.0) | 72 (2.6) | 57 (3.8) | 50 (2.6) |
| Southwest Pennsylvania | 57 (3.8) | 67 (2.7) | 75 (2.7) | 54 (3.3) | 52 (3.8) |
| Australia | 48 (1.6) | 73 (1.4) | 75 (1.2) | 51 (1.6) | 40 (1.5) |
| Canada | 56 (1.4) | 74 (1.2) | 76 (1.1) | 62 (1.5) | 68 (1.8) |
| Chinese Taipei ² | 50 (1.4) | 88 (0.7) | 61 (1.3) | 52 (1.3) | 29 (0.9) |
| Czech Republic ³ | -- | -- | -- | -- | -- |
| England | 53 (1.6) | 87 (0.9) | 63 (2.1) | 55 (1.6) | 28 (1.3) |
| First in the World Consort., IL | 65 (2.9) | 68 (1.8) | 69 (2.5) | 68 (2.7) | 48 (2.7) |
| Japan | 10 (0.8) | 74 (1.1) | 29 (1.3) | 21 (0.8) | 7 (0.6) |
| Korea, Rep. of | 14 (0.8) | 73 (1.1) | 27 (0.8) | 36 (1.0) | 12 (0.6) |
| Michigan | 67 (2.4) | 69 (2.3) | 82 (1.3) | 60 (2.5) | 74 (2.3) |
| Michigan Invitational Group, MI | 70 (1.6) | 67 (2.2) | 81 (1.5) | 58 (2.2) | 69 (1.8) |
| Naperville Sch. Dist. #203, IL | 82 (1.7) | 75 (2.0) | 79 (1.9) | 62 (1.9) | 66 (1.6) |
| Netherlands ³ | -- | -- | -- | -- | -- |
| Project SMART Consortium, OH | 71 (2.2) | 66 (2.2) | 74 (1.9) | 57 (1.9) | 63 (2.2) |
| Singapore | 58 (0.9) | 85 (0.9) | 75 (0.9) | 39 (1.5) | 44 (1.6) |

Background data provided by students.

- 1 International average is for countries where science is taught as a single general/integrated science course at grade 8.
- 2 Students were asked about 'natural science'; data pertain to a grade 8 physics/chemistry course.

- 3 Data are not available for these countries where science is taught as separate courses at grade 8.

States in italics did not fully satisfy guidelines for sample participation rates (see Appendix A).

- () Standard errors appear in parentheses. Because results are rounded to the nearest whole number, some totals may appear inconsistent.

SOURCE: IEA Third International Mathematics and Science Study (TIMSS) 1998-1999

How Do Students Perceive Their Ability in Mathematics and Science?

To investigate how students think of their abilities in mathematics, TIMSS created an index of students' self-concept in mathematics (SCM). It is based on student's responses to five statements about their mathematics ability:

- I would like mathematics much more if it were not so difficult
- Although I do my best, mathematics is more difficult for me than for many of my classmates
- Nobody can be good in every subject, and I am just not talented in mathematics
- Sometimes when I do not understand a new topic in mathematics initially, I know that I will never really understand it
- Mathematics is not one of my strengths.

Students who disagreed or strongly disagreed with all five statements were assigned to the high level of the index, while students who agreed or strongly agreed with all five were assigned to the low level. The medium level includes all other combinations of responses.

The percentages of eighth-grade students at each index level, and their average mathematics achievement, are presented in Exhibit 5.14. Across participating countries, the United States was among those with the greatest percentages of students at the high level of the self-concept index: 31 percent compared with 18 percent on average

across all countries. A number of the comparator countries also reported similarly high percentages (27 to 35 percent), including Australia, Canada, England, and the Netherlands. Several of the Benchmarking participants had even greater percentages at the high level, notably the Naperville School District and the First in the World Consortium, with 40 percent or more of students at this level.

Although there was a clear positive association between self-concept and mathematics achievement within every country and within every Benchmarking jurisdiction, the relationship across entities was more complex. Several comparator countries with high average mathematics achievement, including Singapore, Chinese Taipei, Korea, and Japan, had relatively low percentages of students (15 percent or less) in the high self-concept category. Since all of these are Asian Pacific countries, they may share cultural traditions that encourage a modest self-concept.

Index Description

Index based on students' responses to five statements about their mathematics ability: 1) I would like mathematics much more if it were not so difficult; 2) although I do my best, mathematics is more difficult for me than for many of my classmates; 3) nobody can be good in every subject, and I am just not talented in mathematics; 4) sometimes, when I do not understand a new topic in mathematics initially, I know that I will never really understand it; 5) mathematics is not one of my strengths. High level indicates student disagrees or strongly disagrees with all five statements. Low level indicates student agrees or strongly agrees with all five statements. Medium level includes all other combinations of responses.

| | High Self-Concept (SCM) | | Medium Self-Concept (SCM) | | Low Self-Concept (SCM) | |
|---------------------------------|-------------------------|---------------------|---------------------------|---------------------|------------------------|---------------------|
| | Percent of Students | Average Achievement | Percent of Students | Average Achievement | Percent of Students | Average Achievement |
| International Average | 18 (0.2) | 547 (1.1) | 67 (0.2) | 486 (0.7) | 15 (0.1) | 436 (0.9) |
| United States | 31 (1.0) | 551 (4.6) | 58 (0.8) | 493 (3.9) | 11 (0.6) | 435 (5.6) |
| <i>Pennsylvania</i> | 34 (1.7) | 543 (8.3) | 56 (1.3) | 499 (5.5) | 10 (0.9) | 443 (6.3) |
| Southwest Pennsylvania | 36 (1.9) | 553 (7.8) | 56 (1.6) | 504 (7.6) | 8 (0.7) | 447 (11.7) |
| Australia | 30 (1.2) | 571 (4.7) | 57 (1.0) | 517 (5.0) | 13 (0.7) | 458 (5.4) |
| Canada | 35 (1.0) | 573 (2.9) | 56 (1.0) | 517 (2.4) | 9 (0.5) | 459 (6.1) |
| Chinese Taipei | 11 (0.5) | 660 (6.0) | 75 (0.7) | 591 (3.9) | 14 (0.7) | 506 (4.2) |
| Czech Republic | 19 (1.2) | 585 (5.7) | 66 (1.0) | 515 (4.0) | 15 (1.0) | 461 (5.5) |
| England | 30 (1.3) | 543 (5.0) | 61 (1.2) | 487 (3.9) | 9 (0.6) | 430 (6.5) |
| First in the World Consort., IL | 40 (2.5) | 590 (6.9) | 55 (3.1) | 545 (6.1) | 5 (1.1) | 481 (9.0) |
| Japan | 6 (0.4) | 634 (6.2) | 82 (0.5) | 581 (1.8) | 12 (0.5) | 536 (3.8) |
| Korea, Rep. of | 10 (0.5) | 646 (4.0) | 85 (0.5) | 585 (1.8) | 5 (0.3) | 515 (5.7) |
| Michigan | 36 (1.6) | 554 (7.4) | 53 (1.7) | 508 (6.7) | 11 (0.8) | 452 (6.4) |
| Michigan Invitational Group, MI | 33 (2.3) | 568 (6.1) | 55 (2.2) | 527 (4.7) | 12 (1.0) | 465 (13.0) |
| Naperville Sch. Dist. #203, IL | 44 (1.4) | 597 (3.9) | 49 (1.7) | 554 (3.1) | 7 (0.8) | 507 (7.6) |
| Netherlands | 27 (2.0) | 578 (7.0) | 65 (1.8) | 532 (7.7) | 8 (0.9) | 490 (9.8) |
| Project SMART Consortium, OH | 34 (2.2) | 562 (8.4) | 56 (2.0) | 509 (7.1) | 10 (1.2) | 448 (7.5) |
| Singapore | 15 (1.0) | 656 (8.8) | 74 (0.8) | 603 (5.7) | 11 (0.7) | 547 (7.1) |

States in italics did not fully satisfy guidelines for sample participation rates (see Appendix A).

() Standard errors appear in parentheses. Because results are rounded to the nearest whole number, some totals may appear inconsistent.

As in mathematics, TIMSS created an index of students' self-concept in science (SCS). It is based on student's responses to four statements about their science ability:

- I would like science much more if it were not so difficult
- Although I do my best, science is more difficult for me than for many of my classmates
- Nobody can be good in every subject, and I am just not talented in science
- Science is not one of my strengths.

In countries where the sciences are taught as separate subjects, students were asked about each subject separately. Those data are not presented in this report; however, they are available in the full Benchmarking reports.

The percentages of eighth-grade students at each index level, and their average science achievement, are presented in Exhibit 5.15. Among all the single-science countries, the United States had the greatest percentage of students at the high level of the self-concept index: 45 percent compared with 26 percent on average across countries. Several of the Benchmarking participants had even greater percentages at the high level, notably the First in the World Consortium with 51 percent of students at this level.

Although there was a clear positive association between self-concept and science achievement within every country and within every Benchmarking jurisdiction, the relationship across entities, as was true in mathematics, was more

complex. The same Asian Pacific countries with high average science achievement, including Singapore, Japan, Chinese Taipei, and Korea, had relatively low percentages of students (21 percent or less) in the high self-concept category, potentially indicating a cultural difference.

Clearly, in both mathematics and science, at least within the cultural context of the U.S., eighth-grade students who reported a higher self-concept related to mathematical and scientific ability also exhibited higher achievement. While there is a strong relationship in the U.S., these data cannot determine causality in either direction. Indeed, success and self-concept seem related, but it remains unclear whether self-concept is a precursor to success or a product of it. Surely though, on an intuitive basis it might be assumed that students not provided with opportunities for success in mathematics or science would seem to be at a distinct disadvantage for high self-concept or further success.

Index Description

Index based on students' responses to four statements about their science ability: 1) I would like science much more if it were not so difficult; 2) although I do my best, science is more difficult for me than for many of my classmates; 3) nobody can be good in every subject, and I am just not talented in science; 4) science is not one of my strengths. High level indicates student disagrees or strongly disagrees with all four statements. Low level indicates student agrees or strongly agrees with all four statements. Medium level includes all other combinations of responses.

| | High Self-Concept (SCS) | | Medium Self-Concept (SCS) | | Low Self-Concept (SCS) | |
|------------------------------------|-------------------------|---------------------|---------------------------|---------------------|------------------------|---------------------|
| | Percent of Students | Average Achievement | Percent of Students | Average Achievement | Percent of Students | Average Achievement |
| International Average ¹ | 26 (0.2) | 521 (1.4) | 56 (0.2) | 475 (1.0) | 18 (0.2) | 439 (1.3) |
| United States | 45 (1.2) | 550 (4.5) | 40 (0.8) | 505 (4.4) | 15 (0.7) | 459 (6.2) |
| <i>Pennsylvania</i> | 42 (1.2) | 556 (6.5) | 42 (0.8) | 521 (6.5) | 16 (1.2) | 489 (10.6) |
| Southwest Pennsylvania | 48 (2.3) | 568 (8.9) | 37 (1.3) | 532 (8.1) | 15 (1.9) | 500 (10.5) |
| Australia | 37 (1.2) | 581 (4.4) | 45 (1.0) | 531 (4.8) | 19 (1.0) | 486 (5.3) |
| Canada | 38 (0.8) | 562 (2.5) | 45 (0.7) | 526 (2.9) | 17 (0.6) | 490 (4.7) |
| Chinese Taipei ² | 14 (0.6) | 617 (5.1) | 61 (0.8) | 572 (4.9) | 25 (0.8) | 538 (4.0) |
| Czech Republic ³ | -- | -- | -- | -- | -- | -- |
| England | 42 (1.3) | 573 (5.8) | 45 (1.2) | 528 (4.6) | 13 (0.8) | 486 (8.6) |
| First in the World Consort., IL | 51 (1.8) | 587 (6.3) | 36 (1.8) | 553 (5.6) | 13 (1.3) | 515 (8.7) |
| Japan | 21 (0.6) | 592 (4.1) | 63 (0.6) | 543 (2.3) | 16 (0.6) | 521 (4.4) |
| Korea, Rep. of | 12 (0.5) | 601 (5.0) | 80 (0.6) | 547 (2.6) | 8 (0.4) | 490 (4.5) |
| Michigan | 49 (1.7) | 572 (8.9) | 37 (1.3) | 531 (8.6) | 13 (1.0) | 498 (9.7) |
| Michigan Invitational Group, MI | 48 (2.9) | 587 (7.1) | 40 (2.2) | 556 (5.2) | 11 (1.2) | 508 (9.8) |
| Naperville Sch. Dist. #203, IL | 46 (2.2) | 613 (5.9) | 40 (1.9) | 572 (4.5) | 14 (1.2) | 523 (7.1) |
| Netherlands ³ | -- | -- | -- | -- | -- | -- |
| Project SMART Consortium, OH | 46 (2.9) | 571 (8.9) | 39 (1.8) | 524 (7.6) | 15 (1.9) | 486 (7.8) |
| Singapore | 21 (1.1) | 616 (8.9) | 59 (0.8) | 562 (7.8) | 19 (0.9) | 533 (8.7) |

- 1 International average is for countries where science is taught as a single general/integrated science course at grade 8.
- 2 Students were asked about 'natural science'; data pertain to a grade 8 physics/chemistry course.
- 3 Data are not available for these countries where science is taught as separate courses at grade 8.

States in italics did not fully satisfy guidelines for sample participation rates (see Appendix A).

() Standard errors appear in parentheses. Because results are rounded to the nearest whole number, some totals may appear inconsistent.

SOURCE: IEA Third International Mathematics and Science Study (TIMSS) 1998-1999

The Complexity of Instruction

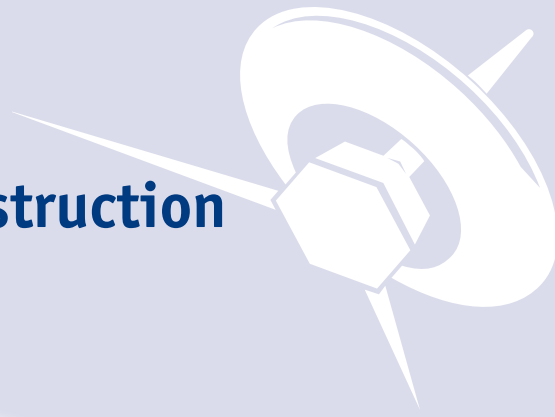

The data presented here and in the full Benchmarking reports paint a varied and complex picture of teaching, clearly pointing to the conclusion that there is no “silver bullet” that will impact achievement. TIMSS offers good information to examine the region’s curricular and instructional practices. The message that educators need to bring coherence, rigor, and depth to the curriculum is direct and clear. The message for instruction is equally clear: it is important to recognize the complex context for teaching and learning and carefully consider appropriate responses. Tinkering with single issues or practices is ill-advised.

Stigler and Hiebert, authors of *The Teaching Gap*,⁵ often speak about an example from the TIMSS 1995 video study related to the use of overhead projectors to highlight this point. One of the observations made from the videotapes of U.S. and Japanese mathematics lessons was that U.S. teachers used overhead projectors often. Japanese teachers instead primarily used a chalkboard. Japanese students substantially outperformed U.S. students in mathematics, so one might be tempted to attribute some of that achievement difference to the use of the chalkboard instead of overhead projectors. Far from the technology involved, a closer in-depth analysis of teaching behavior points not to the medium used for instruction, but rather to the *ways* in which teachers used the materials to foster student engagement as the more important factor potentially impacting achievement.

So too, the data from TIMSS 1999 offer similar opportunities to explore these complexities and thoughtfully reflect on pedagogy. Generally, highest student achievement is exhibited by students exposed to varied teaching approaches where pedagogy is appropriately aligned with the nature of the content and the learning needs of students. Again, TIMSS does not point to

5 Stigler, J.W. and Hiebert, J. (1999), *The Teaching Gap*, New York, NY: The Free Press, A Division of Simon & Schuster.

an instructional “silver bullet” or quick-fix, but rather endorses a focused, coherent, rigorous curriculum taught by knowledgeable teachers who adjust their pedagogy to student needs. While this is not a new call to educators or policy makers, it is a clear reaffirmation of what Southwest Pennsylvania must do if the region is serious about impacting student achievement.

Careful secondary analyses of the data from TIMSS and other local school district and state data may help to identify areas for concentrated efforts. Professional development opportunities might best be used to allow educators collegial time to explore these data and design further offerings for their colleagues that support a varied and responsive pedagogy. Some of the regional initiatives that are designed to make best use of TIMSS findings and recommendations are outlined in the next chapter, as is a call to action in chapter 7.



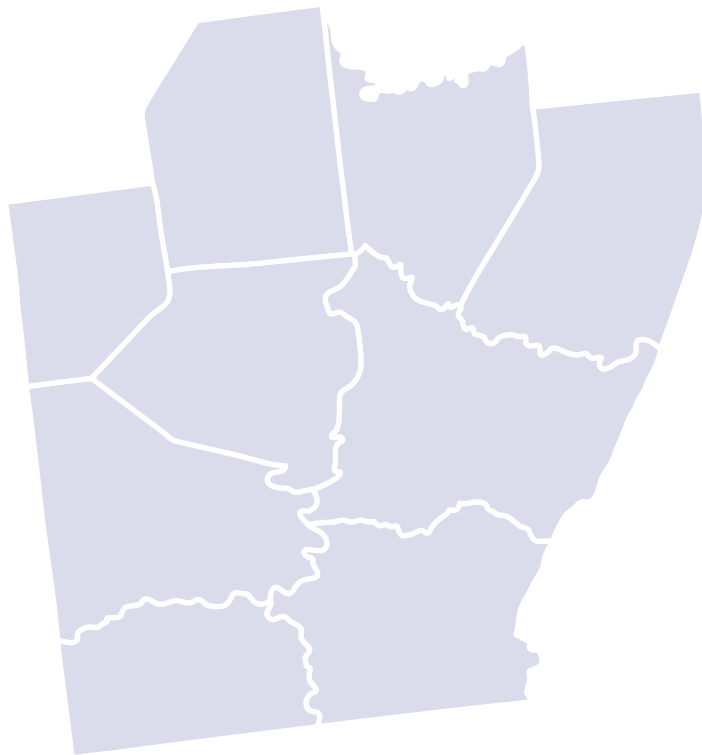

Chapter 6

The Role of TIMSS in Regional Initiatives



Louis Tamler, M.B.A.





In this chapter:

- Introducing Educators to TIMSS Findings
- Examining TIMSS Findings
- Exploring Exemplary Curricular Materials
- Supporting Implementation of Exemplary Materials and Instructional Practices
- Sharing Successes Around Projects That Have Considered TIMSS

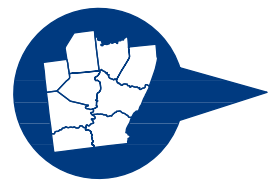

Educators throughout Southwest Pennsylvania have taken lessons learned from TIMSS 1995 and 1999 as well as other data sources to strengthen mathematics and science instruction and inform decision making. A variety of programs, initiatives, and processes are currently in place to ensure that information from this report is readily available to individual teachers and districts that seek to improve mathematics and science instruction through thoughtful application of TIMSS research. Efforts to support educators in this process include the following:

- Introducing educators to TIMSS findings
- Examining TIMSS findings
- Exploring exemplary curricular materials
- Supporting the implementation of exemplary curricular materials and instructional practices suggested by TIMSS
- Sharing related TIMSS successes

Introducing Educators to TIMSS Findings

The Southwest Pennsylvania region served by the Math & Science Collaborative is composed of eleven counties and includes 140 school districts. By sharing information about TIMSS 1995 through conferences, workshops, and seminars, educators in the region developed a basic understanding of this international study and how it was administered. Some also began to realize that the wealth of TIMSS data could be used in professional devel-

opment to discuss ways of strengthening teaching and learning in mathematics and science and have begun to consider and implement strategies suggested by TIMSS. Having data specific to Southwest Pennsylvania through TIMSS 1999 can only deepen the dialogue and make it more meaningful to local educators.

Through TIMSS 1995 we learned that to be effective, introductions to the data need to incorporate a variety of media and as many different perspectives as possible. We also learned that the complexity of the data and findings indicate that repeated exposure is necessary for meaningful understanding. It is not surprising, therefore, that initiatives that have been successful in the past are being replicated for the distribution of the TIMSS 1999 data and findings.

Math & Science Collaborative Initiatives

The Math & Science Collaborative has a variety of ways to share information with Southwest Pennsylvania educators and has used each of them to introduce educators to TIMSS information. These include:

- *The Math & Science Collaborative Journal:* Southwest Pennsylvania educators communicate and share information about a variety of resources and opportunities in this publication. Each edition of this annual journal contains 10 to 15 articles written by stakeholders and educators on topics related to mathematics and science education in the region. Many articles discuss TIMSS directly or consider programs and/or strategies suggested by TIMSS data or

findings. The journal is free and distributed to 18,000 educators in eleven counties every September. Educators who have not received a copy of this publication should check with building principals or department chairs since it is distributed to every district in the region.

- *Network Connections*: This opportunity allows educators from the region to meet semi-annually at the Carnegie Science Center to participate in discussions that center on using innovative instructional materials, implementing and integrating educational technology, and transferring research into practice. TIMSS has been at the heart of many Network Connection sessions.
- *INTERACT (Invitation To Effectively Reflect and Collaborate Together)*: A unique feature of Network Connections is the afternoon session of INTERACT. The purpose of INTERACT is to facilitate cross school and cross district sessions so educators may network with individuals or groups who may be helpful in meeting identified needs. Another purpose is to give educators an opportunity to process information with colleagues and develop plans for sharing the information within their district. All Network Connection attendees have the opportunity to participate in INTERACT.
- *The Math & Science Collaborative Website*: The Collaborative also offers information and resources about TIMSS data and findings via its web site. Organizations and individuals are encouraged to make use of and add to the work done as they develop presentations designed for their particular audiences. To support this ven-

ture, the Math & Science Collaborative has put together a regional TIMSS Kit that can assist educators and resource partners in developing strategies for sharing information. Materials available in the TIMSS Kit can be obtained by contacting the Collaborative.

Other Opportunities for an Introduction to TIMSS

Southwest Pennsylvania has a wide range of existing organizations that support discussion of educational issues. Many of them included sessions on TIMSS at workshops and annual meetings, or disseminated TIMSS information in other ways. These organizations include but are not limited to the following:

- *The Principals Academy*: This on-going project, sponsored by the School of Education's Department of Administrative and Policy Studies of the University of Pittsburgh, provides principals with opportunities to network and collaboratively explore instructional and administrative issues.
- *The Pennsylvania School Board Association*
- *Parents and Teachers Association of Pennsylvania*
- *The Governors Institute for Mathematics and Science*: Funded by the Pennsylvania Department of Education, these week-long institutes for mathematics and science teachers have included information from TIMSS.

- *College in High School*: Sponsored by the University of Pittsburgh, this program offers college credit courses to high school students and educational support for its teachers. TIMSS has been used in professional development efforts.
- *The Pennsylvania Science Teachers Association*
- *The Pennsylvania Council of Teachers of Mathematics*
- *Research for Better Schools*: This non-profit organization provides a listserv focusing on TIMSS findings and educational research.
- *Educational Policy and Issues Center*: The EpiCenter publishes the annual Regional Education Index Report and included TIMSS findings among its indicators of education in the region in 2001.

Additional information on these and other organizations in Southwest Pennsylvania that introduce educators to TIMSS findings can be found at the Math & Science Collaborative's website: www.msc.collaboratives.org.



Examining TIMSS Findings

Once educators have been introduced to TIMSS, they need to be provided with facilitated opportunities to explore the findings in more depth. Because TIMSS speaks to such a wide range of issues, an educator can find relevance when given the freedom to ask, “What do these findings have to say to me?” Examining the data in the context of their own teaching may lead to suggestions for changes in practice and policy. Regional opportunities for educators to engage in this process have been provided through the Math & Science Collaborative Steering Council, Core Leadership Training, and Resource Partner Meetings.

The *Math & Science Collaborative Steering Council* was a driving force in supporting the decision to have Southwest Pennsylvania participate in TIMSS 1999. The Steering Council, made up of representatives from a broad range of regional stakeholders, including educators, universities, corporations, non-profit organizations, parents, and students, guides the Collaborative.

During the past few years, the Steering Council has committed a number of its meetings to exploring TIMSS data. Through the process of examining TIMSS, Steering Council members have considered opportunities for ways TIMSS data might best inform the work of stakeholders across the region. Steering Council representatives are newly elected or appointed every fall, via the regional Network Connections meetings. Information regarding the Steering Council can be found in the *Journal*. Southwest Pennsylvania stakeholders interested in serving on the Steering Council should contact the Math & Science Collaborative.

Core Leadership Training emphasizes professional development that builds a “Community of Practice” by involving groups of educators in an ongoing discussion. More than 45 districts from throughout Southwest Pennsylvania have sent teams of teachers and administrators to participate in three full days of facilitated planning that have used TIMSS as well as Pennsylvania and national mathematics and science standards as topics for deliberation. After being presented with a variety of opportunities to consider the TIMSS findings with respect to their own district context, participants in Core Leadership Training complete professional development plans for the following school year. These plans are to be implemented within their own district, with members of the team taking a leadership role.

During the final session, district teams share their professional development plans with each other. This provides an opportunity to modify and/or strengthen the plans and consider sharing regional resources. Although teams receive the same training and materials, plans vary according to the needs of each district. Additional information regarding results of past Core Leadership Training and how to get involved in upcoming sessions can be found in the *Journal*.

Resource Partner Meetings are designed to encourage collaboration among those individuals and organizations that provide resources to K-12 educators in the region. During a number of these meetings many of the region’s resource partners had their first opportunity to begin exploring TIMSS. Resource partners were encouraged to consider how TIMSS findings might inform and strengthen their programs and how they might share their strategies with others.

Exploring Exemplary Curricular Materials

TIMSS 1995 and 1999 point to a need to explore curricular alternatives in mathematics and science instruction. A number of opportunities currently exist for educators to explore materials that have been designated exemplary or promising by the U.S. Department of Education. The materials were created through a comprehensive research and development process. They have been piloted and field tested with ethnically diverse student populations throughout the United States, and commercially published for widescale implementation. A list of the currently available exemplary materials is provided in appendix B. Regional efforts to support the explorations of exemplary curricular materials recognize the value of providing teachers with the following:

- Access to materials in formal and informal settings
- Opportunities to develop a conceptual understanding of the materials and their intended use
- Access to colleagues and others well acquainted with the materials and experienced in their use
- Adequate time to become comfortable with the materials and the instructional practices associated with them

With these considerations in mind, a number of regional initiatives have been created to familiarize educators with innovative mathematics and science curricular materials and the instructional practices

associated with them. What follows is a brief overview of four regional resources currently in place to aid educators in their efforts to improve mathematics and science education through innovative and proven instructional materials.

Curriculum Focal Point

The *Curriculum Focal Point (CFP)* is a library of exemplary curricular materials housed at the Carnegie Science Center. The CFP is designed for use by educators involved in making curricular decisions for their classrooms, schools, and/or districts. Educators can choose to use the center on their own or with the help of a Carnegie Science Center staff member. Educators can also opt to attend one or more of a series of CFP workshops designed to provide in-depth exploration of a particular material. Additional information about the Curriculum Focal Point can be obtained by contacting the Carnegie Science Center's Director of Professional Development.

FOCUS

FOCUS (Focus on Conceptual Understanding in Science) is a program that was created when eighteen Southwest Pennsylvania school districts came together to consider science curriculum issues at the middle school level. FOCUS planning was driven by the positive experience participating districts had implementing systemic reforms in science at the elementary level and on middle school science needs identified by TIMSS. In its fifth year in 2001, FOCUS has sponsored

Curriculum Showcases that highlight exemplary materials in physical science, earth and space science, and life science. Because of the work being done by the participating districts, a wide range of exemplary materials are now in use in middle schools throughout Southwest Pennsylvania.

Many of the teachers using these materials are willing to open their classrooms to interested colleagues. Additionally, FOCUS professional development opportunities are open to all Southwest Pennsylvania school districts. Additional information about FOCUS and specific professional development opportunities available through FOCUS can be found in the Math & Science Collaborative's *Journal* or at www.pa-edresources.net.

Secondary Mathematics Project

Robert Morris College is working with a group of regional teacher leaders to strengthen middle and high school mathematics. The *Secondary Mathematics Project* will focus on helping Southwest Pennsylvania teachers use exemplary curricula in grades 7-12. The project goal is to form a teacher leadership cadre who will pilot these materials so that they can, in turn, become a resource for adoption of the materials in their own districts and others. In addition, a series of six one-day workshops, each focusing on a particular exemplary curricular material, will be offered in conjunction with the Curriculum Focal Point. More information on these workshops can be found in the Math & Science Collaborative's *Journal* or by contacting the Carnegie Science Center.

Middle School Mathematics Project: “What’s the Big Idea?”

“*What’s the Big Idea?*” was designed to introduce mathematics teachers to content-rich problem sets that require students to work together, write about mathematics, use a variety of strategies and think deeply. These are processes emphasized in the standards and address issues raised by TIMSS.

Developed by the Math & Science Collaborative with the support of McDonald’s Corporation, “*What’s the Big Idea?*” is a collection of more than 40 middle school mathematics problems. Teacher leaders from middle schools in Southwest Pennsylvania identified or created mathematics tasks that are linked to the Big Ideas identified in the Regional Mathematics Curriculum Framework. Because of this, it can be used as a tool to present coherent curriculum in a hands-on, problem-solving format.

Copies of “*What’s the Big Idea?*” were sent, free of charge, to every middle school mathematics teacher in the region. A team of teacher leaders have worked together to create professional development opportunities that support these materials.

For information regarding “*What’s the Big Idea?*” call 412-201-7409. “*What’s the Big Idea?*” can be downloaded at www.msc.collaboratives.org.

Supporting Implementation of Exemplary Materials and Instructional Practices

Efforts to encourage teachers to use exemplary materials and experiment with instructional practices that support their use have taken different forms, each dependent on subject and grade level. All efforts, however, are premised on the belief that if materials and instructional practices are to have a positive impact on student achievement, a sustained focus on developing teachers’ capabilities to deliver these materials is necessary.

Lessons learned from regional efforts to support implementation of exemplary materials and instructional practices emphasize the need for ongoing professional development programs. Further, a major component of these programs must provide opportunities for teachers who are using these materials to interact and share instructional strategies.

Five regional programs are currently in place that provide support for educators and districts intent on implementing reforms suggested by TIMSS. These programs include ASSET; DASH/FAST; The Regional Mathematics Curriculum Framework; The Cognitive Tutor; and Girls, Math and Science.

ASSET

ASSET (Allegheny Schools Science Education and Technology) began working with elementary schools throughout Allegheny County (the central, most urban county in Southwest Pennsylvania) in 1993. It has served as an agent for education reform by patterning its actions on the inquiry model, a model adopted years ago by the corpo-

rate culture and decades ago by the scientific community. Through listening to teacher and district needs, and responding with appropriate resources, ASSET has supported efforts in more than 2,500 classrooms in over 50 districts.

ASSET works with educators throughout the region to develop the types of professional development needed to improve their facility with an inquiry approach to science education and continue to strengthen teacher's abilities to use exemplary curricular materials. ASSET also provides a materials resource center that serves as a distribution and refurbishment point for districts using those materials.

For more information on ASSET, call 412-771-2121 or visit www.assetinc.org.

DASH/FAST

Developmental Approaches in Science, Health and Technology (DASH) and Foundational Approaches in Science Teaching (FAST) are exemplary programs for grades K-5 and 6-8 developed at the University of Hawaii and disseminated in Southwest Pennsylvania by Carnegie Mellon University. Both programs offer students a hands-on, inquiry-based science program and offer teachers a series of professional development opportunities designed to support their implementation.

For information on DASH and/or FAST contact the Center for University Outreach at Carnegie Mellon University, 412-268-1498.

The Regional Mathematics Curriculum Framework

The K-12 Mathematics Curriculum Framework was developed in part as a response to issues of curricular incoherence raised by TIMSS. The Framework was developed by a team of thirteen K-12 mathematics teachers, supported by the Allegheny Intermediate Unit and facilitated by the Math & Science Collaborative. The Framework identifies six to eight "Big Ideas" at each grade level. Concentrating on these "Big Ideas" allows districts to address all of Pennsylvania's Mathematics Standards in a structure that supports in-depth classroom exploration. The Framework provides districts with a tool to continue rich discussion of mathematics curricular and instructional issues.

The Framework has been presented to teachers and administrators from more than 70 districts in the region. For more information, contact the Allegheny Intermediate Unit through its website: www.aiu3.net. The Allegheny Intermediate Unit is the local entity of the Pennsylvania Department of Education and represents 42 school districts in the urban and suburban areas surrounding Pittsburgh.

Carnegie Learning's Cognitive Tutor

The Cognitive Tutor-Algebra is an exemplary full-year, first year algebra course that integrates technology with classroom materials. The program, developed locally at Carnegie Mellon University, is designed to have students work on cooperative problem-solving activities three days a week in the classroom and on similar computer-based

problems in a computer laboratory the other two days. Problem-solving processes are developed as students investigate and solve real-world problem situations.

Foundations in Southwest Pennsylvania have provided more than two million dollars to support districts in implementing this exemplary curriculum at the high school level. For information on the Cognitive Tutor, call Carnegie Learning, Inc., at 412-683-MATH or visit www.carnegielearning.com.

Girls, Math and Science

Girls, Math and Science is a communications and outreach campaign that seeks to raise awareness about and eliminate the barriers that discourage girls from becoming full participants in the future technology-based workforce of the Pittsburgh region. Working with regional and national partners whose goals and concerns are similar, the campaign promotes positive messages about the value of mathematics and science education for girls by reaching middle school girls, their parents, and teachers. The ultimate aim of the project is to create a culture that values, encourages, and utilizes the demonstrated knowledge, skills, and talents of its girls within a campaign that simultaneously enhances math/science understanding and literacy in the region.

In addition to the communications campaign, the design of *Girls, Math and Science* specifies the creation of an accurate and well-maintained database of national and regional resources available to support and help those who want to move ahead to change the attitudes and enhance the

skills of fourth- through eighth-grade girls. The design also specifies the need for ongoing collaboration with the region's Math & Science Collaborative to facilitate sharing resources and to promote gender sensitivity within all math/science professional development efforts.

The campaign is intended to serve as a catalyst for local initiatives with the potential to impact systemic change in overcoming the barriers which prevent girls, parents, and teachers from adopting and living out the messages of the campaign.

Sharing Successes Around Projects That Have Considered TIMSS

This chapter has offered an overview of programs that introduce, examine, explore, and support TIMSS findings. The chapter also outlined projects aimed at developing teacher leaders so that they in turn may share experiences and successes about TIMSS with other educators.

Lessons learned from the past show that collegial sharing among educators is a necessary strategy to maintain the kinds of educational change called for by TIMSS. Experience teaches us that when educators speak to colleagues and share their successes, the messages are often powerful. Two additional ways educators in the region share TIMSS findings and become aware of exemplary curricular materials are through professional Study Groups and the utilization of existing resources.

Study Groups allow teachers continuing and supported opportunities to meet with colleagues to discuss instruction, process information, and improve practice. When used for professional development, Study Groups may encourage mean-

ingful study of important concepts and the sharing of ideas. Throughout the region, TIMSS findings inform teacher dialogue about mathematics and science. Supporting the development of study groups and school cultures that encourage the sharing of ideas has become an integral piece of many of the projects discussed in this chapter. Educators who are considering forming study groups may wish to consult *The Teaching Gap* by James Stigler and James Hiebert as well as an extensive bibliography of resources and a series of monographs on Study Groups sponsored by the School Performance Network. These materials are available via their web site at www.schoolperformance.net.

Most of the strategies outlined in this chapter are designed to develop teacher leaders who can use their experiences to foster more exploration and understanding of mathematics and science. ASSET uses teachers who were recently introduced to exemplary materials as presenters and facilitators. FOCUS teachers serve as a leadership cadre who take responsibility for program design and implementation. Core Leadership Training is designed to strengthen the skills of district level teams, to create professional development plans for their districts, and to share those plans with colleagues. The Computer Algebra Network links teachers implementing the Cognitive Algebra Tutor to share successes and concerns. Network Connections provides opportunities for dialogue among national presenters and regional practitioners. The *Journal* provides an outlet for educators to share information regarding lessons learned and next steps to enhance science and mathematics education.

In conclusion, the strongest initiatives in Southwest Pennsylvania provide opportunities for educators to share their knowledge and experience. Such initiatives value educators as a vital component of curriculum renewal and link best practices and research in addressing matters of educational concern. These efforts use TIMSS as the *beginning* of a continuing regional dialogue rather than an end point or conclusion.

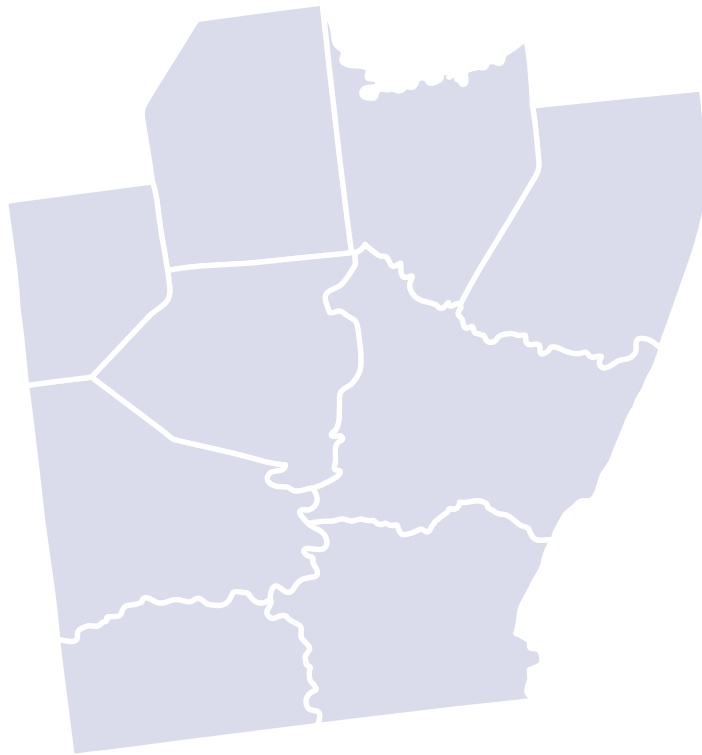

Chapter 7

Next Steps – Implications for Policy and Practice



Nancy R. Bunt, Ed.D.

Louis Tamler, M.B.A.





In this chapter:

- TIMSS Replaces Assumptions with Reality for Southwest Pennsylvania
- TIMSS Is a Guide for Action on Those Realizations
- Engage the Whole School to Strengthen Instruction
- Action Steps for Southwest Pennsylvania



Prior to TIMSS 1995, the information readily available to classroom educators about what was happening in schools in other nations was usually limited to rankings as determined by test scores. The widely publicized TIMSS 1995 deepened that knowledge by providing insight into what produced those rankings. It described the variety of approaches in other educational systems around the world, and made clear that different strategies produce different results. Benchmarking to TIMSS 1999 “brings that discussion home” by describing, within an international context, Southwest Pennsylvania mathematics and science instruction in greater detail than ever before.

Although it is early in the discussion, several implications for policy and practice are clear. Summarized in this chapter, they are followed by more detailed actions proposed for K-12 educators in Southwest Pennsylvania.

- TIMSS replaces assumptions with reality for Southwest Pennsylvania.
 - Acknowledge its similarity to the nation as a whole
 - Move beyond predicting achievement by relative wealth or poverty
- TIMSS is a guide for action on those realizations.
 - Enable achievement at a higher level for more students
 - Pursue coherence in curriculum
 - Engage in on-going refinement of instruction

- TIMSS offers evidence that has relevance beyond mathematics and science, and that can engage the whole school in instructional improvement.

TIMSS Replaces Assumptions with Reality for Southwest Pennsylvania

Acknowledge Similarity to the Nation as a Whole

A stance of “That may be true of the nation, but we’re doing just fine, thanks,” is no longer valid. In Southwest Pennsylvania, what is taught (curriculum), how it’s taught (instruction), and the results of those efforts (student achievement) are overwhelmingly similar to the nation as a whole. This proven similarity soundly validates the on-going efforts throughout the region to address the issues identified by national participation in TIMSS 1995. What was found to be problematic in the nation as a whole is clearly at play in Southwest Pennsylvania. Therefore, the use of solutions developed to address those national concerns should continue to be expanded here.

Move Beyond Predicting Achievement by Relative Wealth or Poverty

Educators in the United States and Southwest Pennsylvania have long been aware that students from well-resourced homes have higher test scores than those from less advantaged backgrounds. Exhibit 7.1, Students Eligible to Receive Free/Reduced Price Lunch, shows that this association was once again present in the relative achievement relationships among the Benchmarking jurisdictions.

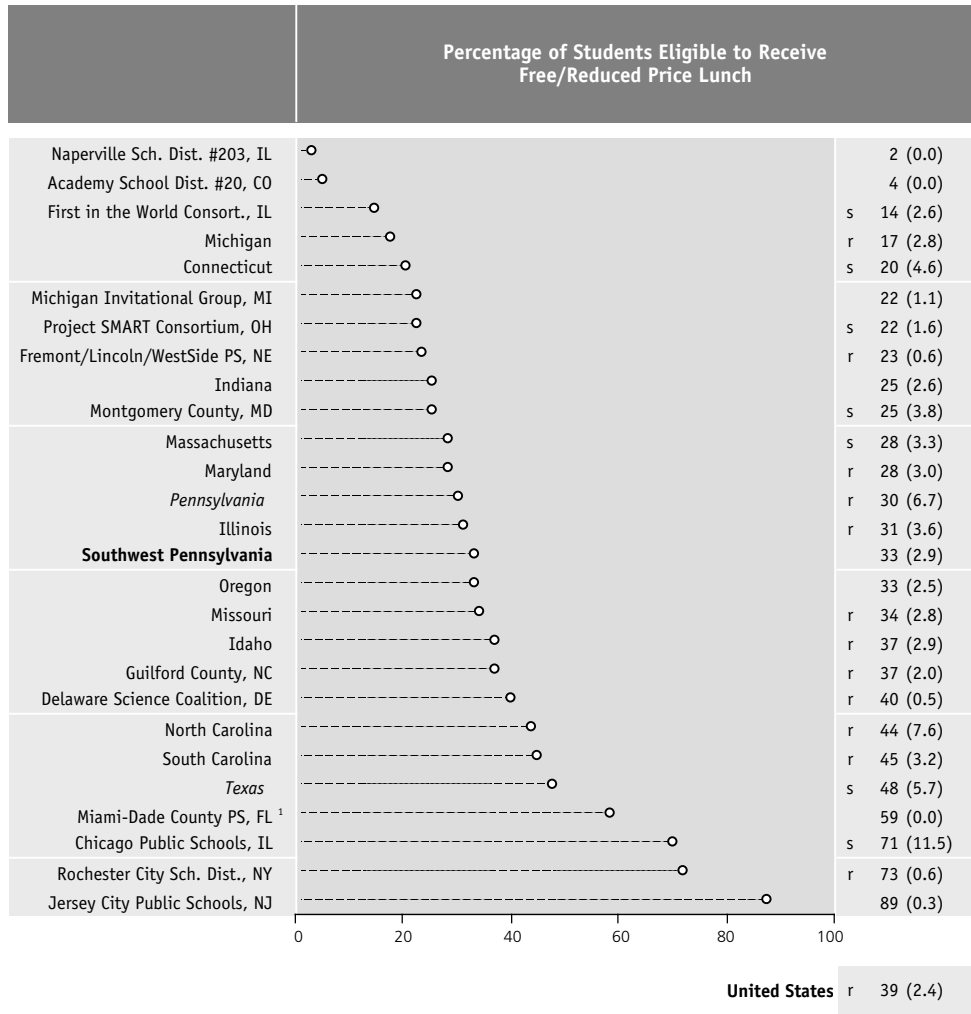

Background data provided by schools.

States in italics did not fully satisfy guidelines for sample participation rates (see Appendix A).

1 Because school response data were available for less than 50% of the students in Miami-Dade, the figure shown is that reported by the Florida Department of Education.

() Standard errors appear in parentheses. Because results are rounded to the nearest whole number, some totals may appear inconsistent.

An "r" indicates school response data available for 70-84% of students. An "s" indicates school response data available for 50-69% of students.

SOURCE: IEA Third International Mathematics and Science Study (TIMSS) 1998-1999

Index Description

Index based on students' responses to three questions about home educational resources: number of books in the home; educational aids in the home (computer, study desk/table for own use, dictionary); parents' education. High level indicates more than 100 books in the home; all three educational aids; and either parent's highest level of education is finished university. Low level indicates 25 or fewer books in the home; not all three educational aids; and both parents' highest level of education is some secondary or less or is not known. Medium level includes all other combinations of responses.

| | High Resources (HER) | | Medium Resources (HER) | | Low Resources (HER) | |
|---------------------------------|----------------------|---------------------------------|------------------------|---------------------------------|---------------------|---------------------------------|
| | Percent of Students | Average Mathematics Achievement | Percent of Students | Average Mathematics Achievement | Percent of Students | Average Mathematics Achievement |
| International Average | 9 (0.1) | 559 (2.3) | 72 (0.2) | 487 (0.8) | 19 (0.2) | 431 (1.2) |
| United States | 22 (1.5) | 555 (5.1) | 73 (1.4) | 492 (3.1) | 4 (0.5) | 427 (6.4) |
| <i>Pennsylvania</i> | 22 (2.7) | 549 (9.7) | 75 (2.6) | 498 (4.8) | 2 (0.4) | ~ ~ |
| Southwest Pennsylvania | 25 (2.8) | 560 (9.5) | 72 (2.9) | 505 (6.8) | 3 (0.8) | 441 (16.2) |
| Australia | 24 (1.5) | 557 (5.1) | 72 (1.4) | 517 (4.9) | 3 (0.4) | 466 (12.5) |
| Canada | 27 (1.0) | 552 (4.1) | 71 (1.0) | 525 (2.2) | 2 (0.2) | ~ ~ |
| Chinese Taipei | 8 (0.7) | 666 (7.2) | 84 (0.7) | 586 (3.6) | 8 (0.6) | 502 (6.6) |
| Czech Republic | 13 (0.8) | 560 (6.8) | 83 (0.8) | 517 (3.9) | 4 (0.5) | 460 (11.3) |
| England | -- | -- | -- | -- | -- | -- |
| First in the World Consort., IL | 45 (2.5) | 580 (7.2) | 53 (2.5) | 546 (6.1) | 2 (0.3) | ~ ~ |
| Japan | -- | -- | -- | -- | -- | -- |
| Korea, Rep. of | 14 (0.8) | 637 (2.8) | 80 (0.8) | 583 (1.9) | 5 (0.3) | 513 (5.0) |
| Michigan | 27 (2.9) | 557 (7.8) | 71 (2.7) | 505 (6.3) | 2 (0.5) | ~ ~ |
| Michigan Invitational Group, MI | 29 (2.6) | 557 (8.5) | 70 (2.6) | 523 (5.8) | 1 (0.3) | ~ ~ |
| Naperville Sch. Dist. #203, IL | 56 (1.3) | 583 (3.5) | 43 (1.3) | 553 (3.3) | 0 (0.2) | ~ ~ |
| Netherlands | 9 (1.1) | 575 (10.4) | 89 (1.1) | 538 (7.1) | 2 (0.8) | ~ ~ |
| Project SMART Consortium, OH | 22 (2.3) | 557 (11.0) | 76 (2.1) | 513 (6.5) | 2 (0.5) | ~ ~ |
| Singapore | 5 (0.7) | 663 (10.0) | 87 (0.6) | 605 (6.0) | 8 (0.7) | 552 (7.3) |

States in italics did not fully satisfy guidelines for sample participation rates (see Appendix A).

A dash (-) indicates data are not available. A tilde (~) indicates insufficient data to report achievement.

() Standard errors appear in parentheses. Because results are rounded to the nearest whole number, some totals may appear inconsistent.

SOURCE: IEA Third International Mathematics and Science Study (TIMSS) 1998-1999

Consistent with a large body of educational research, TIMSS 1999 provides evidence, especially within countries, that student achievement is related to home background factors. That point is illustrated in Exhibit 7.2 in which TIMSS combined three variables – number of books in the home, access to a range of study aids (computer, study desk/table, dictionary), and parent educational level – to form an index of home educational resources. Looking at our comparators, the top-achieving Benchmarking jurisdictions had high percentages of students from well-resourced homes.

However, a closer look adds insight from the international perspective. Despite these findings in the U.S., students at the high level of the resources index were relatively rare in most countries. For example, top performers Singapore and Chinese Taipei had eight percent or fewer of their students at the high level of the index. Clearly, other influences besides home resources are at work to produce achievement.

To explore this issue further, the International Study Center at Boston College plotted the relationship between both mathematics and science achievement and GNP (Gross National Product) per capita, given in Exhibits 7.3 and 7.4, respectively. A number of the low-performing countries have relatively low GNP. Interestingly, though, countries with low GNP (shown on the left side) had a range of performance, with some relatively poor countries having high performance, such as the Russia Federation, Slovak Republic, and Hungary. Similarly, countries to the right with relatively high GNP also had a range of performance, from Kuwait to Singapore, the lowest and highest performers among relatively rich countries. The United States, with the highest GNP, had only mediocre performance.

Being quite similar to the United States as a whole, Southwest Pennsylvania's findings would fall about where the U.S. does. By the high performance of countries where home resources are **not** abundant, TIMSS tells us that wealth is neither essential nor necessarily predictive of high achievement – and conversely, that poverty by itself does not preclude high levels of achievement. These exhibits document that students in other countries with far fewer resources attain higher overall mathematics and science achievement. Lack of home resources in the United States and/or Southwest Pennsylvania need not be the sole determining factor in student performance. TIMSS moves beyond poverty indices to focus on *what schools can do* to support achievement.

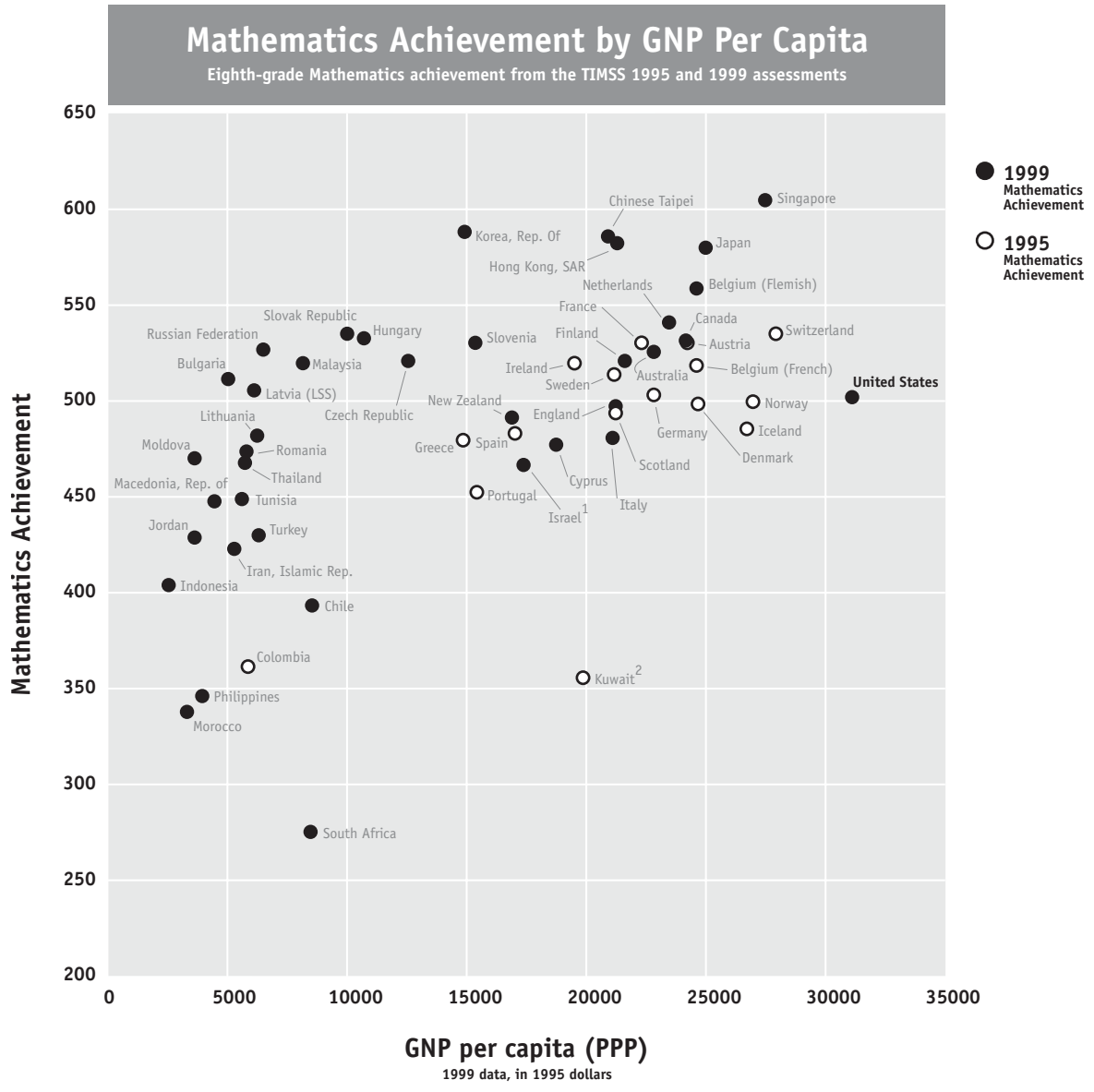

SOURCE: IEA Third International Mathematics and Science Study (TIMSS) 1998-1999

1 Israeli PPP based on 1998 GNP; constant to 1995.
 2 Kuwait PPP based on 1996 GNP; constant to 1995.

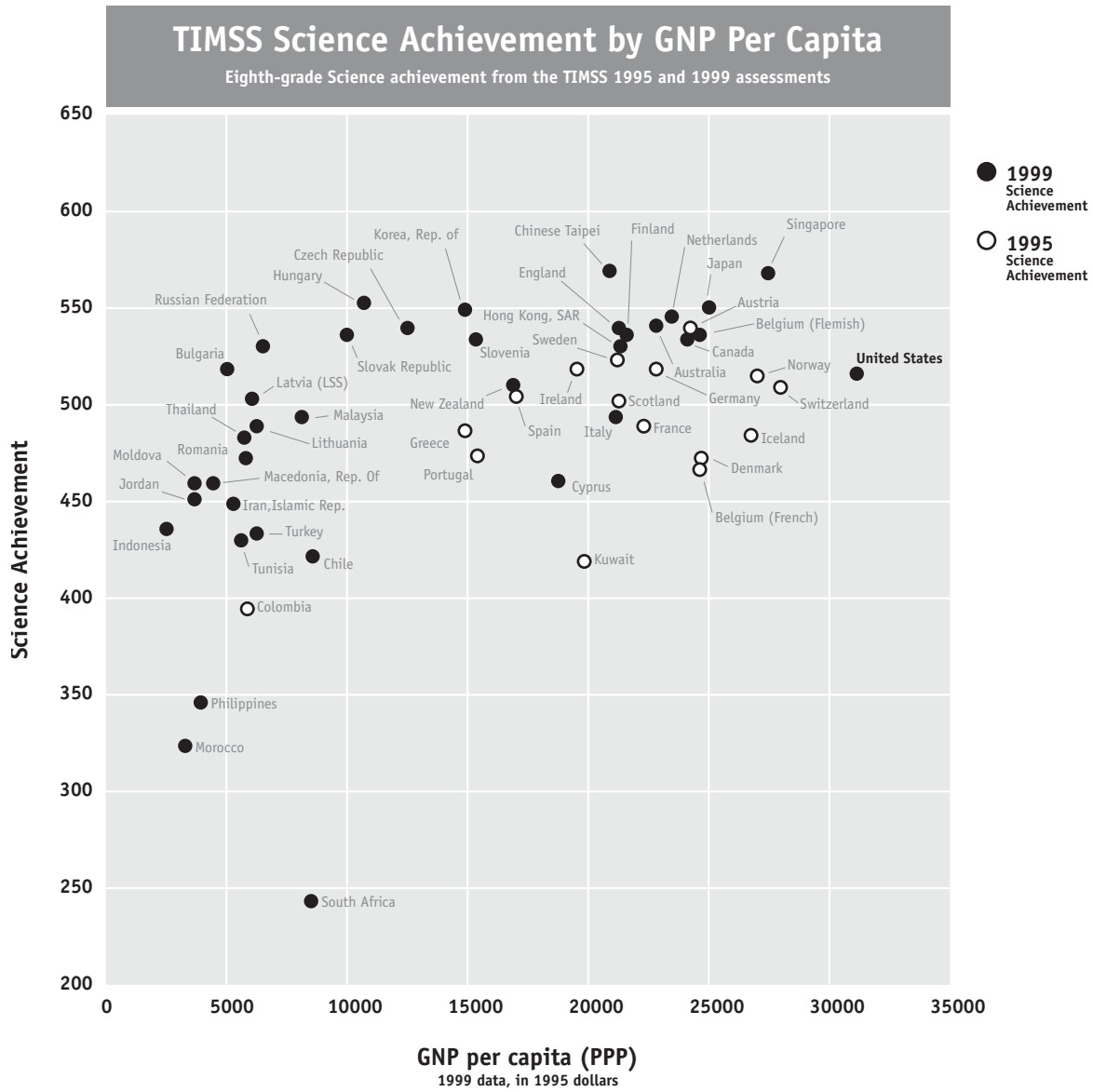

1 Israeli PPP based on 1998 GNP; constant to 1995.
 2 Kuwait PPP based on 1996 GNP; constant to 1995.

SOURCE: IEA Third International Mathematics and Science Study (TIMSS) 1998-1999

TIMSS Is a Guide for Action on Those Realizations

Enable Achievement at a Higher Level for More Students

TIMSS provides evidence that even in countries with far fewer resources than in the United States, more of their students are having success with higher-level mathematics and science. In examining the curriculum and instructional strategies in the high-performing nations, it is clear that most or all of their students are having the opportunity to learn mathematics and science to a much higher level by eighth grade than in Southwest Pennsylvania.

As noted in chapter 4, the majority (70+ percent) of eighth-grade students in high-performing countries are studying a combination of algebra, geometry, and number, while fewer than a third of students in Southwest Pennsylvania are. In the high-performing countries, less than 8 percent of eighth-grade students are still studying primarily arithmetic, while 20 percent of eighth graders in Southwest Pennsylvania still have that primary focus. Students cannot learn what they are not taught. In Southwest Pennsylvania, the prevailing system sorts students into those students who are given the opportunity to learn more challenging content, like algebra and geometry, and those who are restricted to repetitious arithmetic. TIMSS challenges that practice and questions the apparent underlying assumption, *unique to our nation*, that only “some” students are inherently good in mathematics, and therefore can learn higher mathematics, beginning with algebra. Without higher mathematics, most high-level science is unattainable.

The TIMSS 1995 data shed light on the sorting of students into more or less advanced mathematics courses on the international level. At the fourth grade, 92 percent of students, on average internationally, attended schools that reported offering one mathematics course of study for all students; in the U.S., 87 percent of students did so.¹ However, at the eighth grade, internationally 74 percent of students attended schools offering one mathematics course for all students; in contrast, only 17 percent of U.S. students attended such schools. Singapore was similar to the U.S. with 20 percent of its students in schools offering just one mathematics course for all students. But according to the breakdown of who takes what courses, 57 percent of Singapore’s students were enrolled in the most advanced courses, compared with 27 percent in the U.S. In contrast, fully 50 percent of U.S. students were enrolled in the least advanced courses.

TIMSS suggests that challenging content should be made available to all students. In Southwest Pennsylvania this is being addressed by making challenging instructional materials available for all students. This emphasis is manifested in the widespread adoption of exemplary curricular materials for all students in elementary science, and the first steps toward adoption of similar materials at the middle and high school levels of science. It has influenced growing use of exemplary materials in elementary and middle level mathematics for all students. It has fueled interest in the Cognitive Tutor, an exemplary mathematics curriculum that, when implemented effectively, has enabled many more students to be successful with algebra. As noted in chapter 4, the strengthened achievement,

1 Martin, M.O., Mullis, I.V.S., Gonzalez, E.J., Smith, T.A., and Kelly, D.L. (1999), *School Contexts for Learning and Instruction in IEA’s Third International Mathematics and Science Study*, Chestnut Hill, MA: Boston College.

in comparison to the state of Michigan, of the Michigan Invitational Group, which used *only* exemplary materials, would seem to lend additional credence to this strategy.

Pursue Coherence in Curriculum

A key finding of TIMSS 1995, supported by TIMSS 1999, is the negative effect of a confused curriculum on student achievement. The lack of clear understandings regarding what all students are expected to know and be able to do at different stages of their educational careers has created a curricular landscape described as “a mile wide and an inch deep.” National standards were laudable first steps to address this confusion. With the legal authority and responsibility for education, Pennsylvania’s adoption of standards in mathematics and science validated the development of common expectations. However, both national and state standards are defined in grade bands, which can still leave confusion as to appropriate timing of presentation within those bands.

Contributing to the problem, market-driven textbooks too often include material at multiple grade levels to address the varying expectations across 50 states. Most textbook series include checklists showing that they are addressing the standards for the state where they are selling. But unfortunately, what they do not also note is that, since they are also selling in other states, they are meeting those states’ standards too. The resulting thick and expensive books feature too many topics at each grade level because they are including the same topics in multiple grade level texts in order to meet that multiple state market. Without that

clarification, teachers naturally assume that, to do their part, they must cover all the topics in their grade level text. The resulting coverage versus depth dilemma in the U.S. is well documented in TIMSS. Without cooperation across states, to remain solvent, much of the textbook industry continues to offer incoherent guidance to educators, students, and parents.

Many Southwest Pennsylvania districts have begun the work of developing coherent grade-by-grade curriculum that builds strategically upon itself, minimizes repetition, and emphasizes essential understandings. While planning to address agreed upon standards, they are carefully thinking through what should be taught at which grade levels. Some of those districts have been supported in their efforts through the Regional K-12 Mathematics Curriculum Framework, a document designed to encourage and facilitate such work.

Pursue On-going Refinement of Instruction

Both TIMSS 1995 and TIMSS 1999 studies indicate that, while there are many issues around strengthening mathematics and science instruction to improve student achievement, there is no silver bullet. There is no one thing that, if changed, would magically raise student achievement. TIMSS has demonstrated that in many areas where student achievement is strong, educators seriously and continuously reflect on curricular and instructional issues and work on their refinement.

A number of districts in Southwest Pennsylvania are employing schedules that create opportunities for focused collegial interaction between educators. Many are capitalizing on

the potential of learning communities to impact teaching and learning. What TIMSS tells us is that improving practice is both doable and worth doing, but that the work required is neither obvious nor easy. A school culture that promotes the sharing of ideas, resources, and lessons learned is essential.

Engage the Whole School to Strengthen Instruction

TIMSS, while a study of mathematics and science teaching and learning, moves beyond those disciplines to document their inter-relatedness with literacy. Exhibit 7.5 relates students' mathematics achievement to their responses in the student survey to a question, which could be considered an indication of literacy, "Outside of school, how often do you read a book or magazine?" There is a consistently strong relationship between higher achievement in mathematics and higher levels of literacy. While the exhibit is not included, a similar relationship exists between science achievement and literacy. While whether one causes the other cannot be determined, it is probably safe to say that the benefits of increasing achievement in all three domains far outweigh an isolated approach to improving achievement in only one discipline. In the same vein, the implications of TIMSS for policy and practice are most likely equally valid for other disciplines. Improving student achievement involves careful consideration of what is taught and how it is taught in every discipline. TIMSS can contribute to that process.

Action Steps for Southwest Pennsylvania

There are opportunities for higher education to engage in secondary analysis of the data to determine other implications for policy and practice. For example, Dr. William Schmidt, of the U.S. TIMSS National Research Center at Michigan State University, will provide richer information about commonalities of curriculum in Southwest Pennsylvania and its relationship to achievement. To be available later in 2002, that analysis can be a baseline for on-going curriculum analysis. Another area of potential focus raised in chapter 3 is the gender gap in achievement. Others will become apparent as this report and others are scrutinized.

TIMSS is a call to action for K-12 educators to approach the continuous task of strengthening instruction with renewed purpose and vigor. Drawing from this research, educators can explore the numerous ways to approach instruction, and think deeply about which strategies should be used, when, and why. The value of TIMSS is that it clearly points toward the hard but joyful work needed to implement the strategies by which those improvements are most likely. The following suggestions, which reference many of the regional initiatives in chapter 6, may be starting points for action.

1. Explore the Regional K-12 Mathematics Curriculum Framework. Developed at the request of Southwest Pennsylvania school superintendents, it can help individual districts think through curricular issues.

| | About Every Day | | About Once a Week | | About Once a Month | | Rarely | |
|---------------------------------|---------------------|---------------------------------|---------------------|---------------------------------|---------------------|---------------------------------|---------------------|---------------------------------|
| | Percent of Students | Average Mathematics Achievement | Percent of Students | Average Mathematics Achievement | Percent of Students | Average Mathematics Achievement | Percent of Students | Average Mathematics Achievement |
| International Average | 34 (0.2) | 498 (1.0) | 35 (0.2) | 492 (1.0) | 11 (0.1) | 493 (1.3) | 19 (0.2) | 470 (1.2) |
| United States | 28 (0.8) | 521 (5.0) | 35 (0.7) | 512 (3.5) | 16 (0.6) | 511 (4.7) | 21 (0.9) | 477 (4.0) |
| <i>Pennsylvania</i> | 25 (1.9) | 527 (9.0) | 36 (1.1) | 514 (5.4) | 19 (1.2) | 514 (5.9) | 20 (1.5) | 482 (7.1) |
| Southwest Pennsylvania | 25 (1.4) | 541 (9.4) | 38 (1.7) | 522 (7.3) | 18 (1.5) | 514 (7.7) | 20 (1.7) | 485 (7.4) |
| Australia | 34 (1.1) | 541 (5.7) | 40 (0.9) | 528 (5.3) | 15 (0.8) | 512 (7.3) | 11 (0.7) | 490 (5.6) |
| Canada | -- | -- | -- | -- | -- | -- | -- | -- |
| Chinese Taipei | 28 (0.8) | 614 (4.8) | 35 (0.7) | 599 (4.4) | 8 (0.4) | 604 (8.0) | 30 (0.9) | 539 (5.3) |
| Czech Republic | 36 (1.5) | 534 (5.0) | 30 (1.3) | 526 (4.9) | 12 (0.7) | 518 (5.4) | 21 (1.2) | 498 (6.4) |
| England | -- | -- | -- | -- | -- | -- | -- | -- |
| First in the World Consort., IL | 40 (1.9) | 573 (7.5) | 41 (1.9) | 556 (7.4) | 12 (0.8) | 547 (9.4) | 8 (1.2) | 532 (17.1) |
| Japan | 55 (0.9) | 586 (2.4) | 27 (0.8) | 582 (2.8) | 5 (0.3) | 562 (7.7) | 13 (0.5) | 548 (4.7) |
| Korea, Rep. of | 23 (0.6) | 607 (4.0) | 40 (0.7) | 591 (2.9) | 23 (0.6) | 580 (2.5) | 13 (0.5) | 556 (5.2) |
| Michigan | 29 (1.3) | 542 (7.6) | 36 (0.7) | 520 (6.7) | 16 (1.1) | 517 (7.6) | 19 (1.1) | 496 (6.6) |
| Michigan Invitational Group, MI | 33 (1.4) | 552 (6.2) | 35 (1.9) | 534 (7.3) | 15 (1.2) | 529 (8.8) | 17 (1.3) | 504 (7.5) |
| Naperville Sch. Dist. #203, IL | 48 (1.3) | 582 (3.1) | 34 (1.2) | 566 (3.7) | 10 (0.7) | 552 (6.6) | 8 (0.8) | 534 (7.8) |
| Netherlands | -- | -- | -- | -- | -- | -- | -- | -- |
| Project SMART Consortium, OH | 24 (1.7) | 529 (12.3) | 36 (1.4) | 526 (8.1) | 17 (1.4) | 528 (9.1) | 23 (2.1) | 503 (6.5) |
| Singapore | 37 (1.0) | 614 (6.5) | 44 (0.9) | 602 (6.6) | 9 (0.4) | 600 (8.2) | 10 (0.6) | 586 (7.6) |

Background data provided by students.

A dash (-) indicates data are not available.

() Standard errors appear in parentheses. Because results are rounded to the nearest whole number, some totals may appear inconsistent.

2. Join the discussion about the development of a Curriculum Framework for science. Help make it happen.
3. Engage your district in curriculum mapping. Ensure that, during the process, decisions regarding what should be taught when are based on what is best to promote student achievement. One sign of curriculum mapping success is when all those involved in mathematics education, for example, can talk intelligently about what is happening at all grade levels.

4. Seek assessments that measure what is important for students to know. Help build awareness that external assessments paint only a portion of the picture regarding the learning that is occurring. Help develop a comprehensive approach to how student achievement data is gathered, how it is used to strengthen instruction, and how it is shared with parents and other stakeholders.
5. Support the use of exemplary curricular materials that present challenging topics to all students in elementary and middle level mathematics and science classrooms.
 - a. Enable both new and experienced teachers to engage in the professional development needed to ensure effective implementation.
 - b. Document your results, open your doors, and share lessons learned.
 - c. If your district is not yet using exemplary curricular materials in K-8 mathematics, explore those materials through the Curriculum Focal Point or the National Dissemination Centers. Visit classrooms in Southwest Pennsylvania where they are being effectively implemented.
 - d. Participate in regional and district initiatives to strengthen middle level science instruction. Pursue exemplary curricular materials that continue the good work currently being done in life and environmental science, and strengthen instruction in physics and chemistry.
6. Take part in the region's initiative to make the Cognitive Tutor available to students in all Southwest Pennsylvania high schools.
7. Become familiar with the newly emerging high school materials designed to better integrate topics within mathematics and topics within the sciences while ensuring that all students have access to high content. Work with other districts to implement these materials at the high school level. Engage in the regional conversation regarding what support is needed to explore and implement new instructional methods.
8. Make a commitment toward regular interaction with other educators around issues of curriculum and instruction. Document the process and results so that you can share with others in the region the power inherent in serious work with colleagues.
9. Explore various means to support collegial interaction with the time, resources, and expertise needed to maximize its benefits. Hold those involved accountable for agreed upon results, and expect to be held accountable for work with groups you are involved in.
10. Explore the ideas behind lesson study and learning communities. Develop strategies for implementing these tools in ways that make sense for your district.

As educators and policy makers act on these implications, recognize that change takes time. Be accountable for progress, but encourage realistic expectations. Experienced districts indicate that adopting exemplary curricular materials is at least a two-year process. Implementing them effectively involves building an on-going continuous process of refinement of instruction. While effective lesson study may be that on-going process, becoming proficient in using that tool also takes time. Changing cultural activity is possible, but requires time, patience, and a strategic approach. TIMSS Benchmarking charts the course; educators in Southwest Pennsylvania must move along it with the knowledge that every great journey is taken a step at a time.

Appendix A

Overview of TIMSS Benchmarking Procedures



History

TIMSS 1999 represents the continuation of a long series of studies conducted by the International Association for the Evaluation of Educational Achievement (IEA). Since its inception in 1959, the IEA has conducted more than 15 studies of cross-national achievement in the curricular areas of mathematics, science, language, civics, and reading. The Third International Mathematics and Science Study (TIMSS), conducted in 1994-1995, was the largest and most complex IEA study, and included both mathematics and science at third and fourth grades, seventh and eighth grades, and the final year of secondary school. In 1999, TIMSS again assessed eighth-grade students in both mathematics and science to measure trends in student achievement since 1995.¹

To provide U.S. states and school districts with an opportunity to benchmark the performance of their students against that of students in the high-performing TIMSS countries, the International Study Center at Boston College, with the support of the National Center for Education Statistics and the National Science Foundation, established the TIMSS 1999 Benchmarking Study. Through this project, the TIMSS mathematics and science achievement tests and questionnaires were administered to representative samples of students in participating states and school districts in the spring of 1999, at the same time the tests and questionnaires were administered in the TIMSS countries. Participation in TIMSS Benchmarking was intended to help states and districts understand their

comparative educational standing, assess the rigor and effectiveness of their own mathematics and science programs in an international context, and improve the teaching and learning of mathematics and science. Thirteen states, eight public school districts, and six consortia of districts participated in the Benchmarking Study. They are listed in Exhibit 1.1 in chapter 1, together with the 38 countries that took part in TIMSS 1999.

How Was the TIMSS 1999 Benchmarking Study Conducted?

The TIMSS 1999 Benchmarking Study was a shared venture. In conjunction with the Office of Educational Research and Improvement (OERI) and the National Science Foundation (NSF), the National Center for Education Statistics (NCES) worked with the International Study Center (ISC) at Boston College to develop the study. Each participating jurisdiction invested valuable resources in the effort, primarily for data collection including the costs of administering the assessments at the same time and using identical procedures as for TIMSS in the United States. Many participants have also devoted considerable resources to team building as well as to staff development to facilitate use of the TIMSS 1999 results as an effective tool for school improvement.

The TIMSS studies are conducted under the auspices of the International Association for the Evaluation of Educational Achievement (IEA), an independent cooperative of national and governmental research agencies with a permanent secretariat based in Amsterdam, the Netherlands. Its primary purpose is to conduct large-scale

¹ The TIMSS 1999 results for mathematics and science, respectively, are reported in Mullis, I.V.S., Martin, M.O., Gonzalez, E.J., Gregory, K.D., Garden, R.A., O'Connor, K.M., Chrostowski, S.J., and Smith, T.A. (2000), *TIMSS 1999 International Mathematics Report: Findings from IEA's Repeat of the Third International Mathematics and Science Study at the Eighth Grade*, Chestnut Hill, MA: Boston College, and in Martin, M.O., Mullis, I.V.S., Gonzalez, E.J., Gregory, K.D., Smith, T.A., Chrostowski, S.J., Garden, R.A., and O'Connor, K.M. (2000), *TIMSS 1999 International Science Report: Findings from IEA's Repeat of the Third International Mathematics and Science Study at the Eighth Grade*, Chestnut Hill, MA: Boston College.

comparative studies of educational achievement to gain a deeper understanding of the effects of policies and practices within and across systems of education.

TIMSS is part of a regular cycle of international assessments of mathematics and science that are planned to chart trends in achievement over time. Work is under way on TIMSS 2003, and a regular cycle of studies is planned for the years beyond.

The IEA delegated responsibility for the overall direction and management of TIMSS to the International Study Center in the Lynch School of Education at Boston College, headed by Michael O. Martin and Ina V.S. Mullis. In carrying out the project, the International Study Center worked closely with the IEA Secretariat, Statistics Canada in Ottawa, the IEA Data Processing Center in Hamburg, Germany, and Educational Testing Service in Princeton, New Jersey. Westat in Rockville, Maryland, was responsible for sampling and data collection for the Benchmarking Study as well as the U.S. component of TIMSS 1999 so that procedures would be coordinated and comparable.

Developing the TIMSS 1999 Mathematics and Science Tests

The TIMSS curriculum framework underlying the mathematics and science tests was developed for TIMSS in 1995 by groups of mathematics and science educators with input from the TIMSS National Research Coordinators (NRCs). The curriculum framework contains three dimensions or aspects, which are given in Exhibit A.1 for mathematics and Exhibit A.2 for science. The *content* aspect represents the subject matter content of

school mathematics. The *performance expectations* aspect describes, in a non-hierarchical way, the many kinds of performances or behaviors that might be expected of students in school mathematics. The *perspectives* aspect focuses on the development of students' attitudes, interest, and motivation in mathematics. Because the frameworks were developed to include content, performance expectations, and perspectives for the entire span of curricula from the beginning of schooling through the completion of secondary school, some aspects may not be reflected in the eighth-grade TIMSS assessment.² Working within the framework, test specifications for TIMSS in 1995 were developed that included items representing a wide range of mathematics and science topics and eliciting a range of skills from the students. The 1995 tests were developed through an international consensus involving input from experts in mathematics and science and measurement specialists, ensuring they reflected current thinking and priorities in mathematics and science.

About one-third of the items in the 1995 assessment were kept secure to measure trends over time; the remaining items were released for public use. An essential part of the development of the 1999 assessment, therefore, was to replace the released items with items of similar content, format, and difficulty. With the assistance of the Science and Mathematics Item Replacement Committee, a group of internationally prominent mathematics and science educators nominated by participating countries to advise on subject-matter issues in the assessment, over 300 mathematics and science items were developed as potential

² The complete TIMSS curriculum frameworks can be found in Robitaille, D.F., et al. (1993), *TIMSS Monograph No.1: Curriculum Frameworks for Mathematics and Science*, Vancouver, BC: Pacific Educational Press.

replacements. After an extensive process of review and field testing, 114 items were selected for use as replacements in the 1999 mathematics assessment and 98 items in the science assessment.

Exhibit A.1: The Three Aspects and Major Categories of the Mathematics Frameworks

TIMSS 1999
Eighth Grade

Content

Numbers
Measurement
Geometry
Proportionality
Functions, Relations, and Equations
Data Representation
Probability and Statistics
Elementary Analysis, Validation, and Structure

Performance Expectations

Knowing
Using Routine Procedures
Investigating and Problem Solving
Mathematical Reasoning
Communicating

Perspectives

Attitudes
Careers
Participation
Increasing Interest
Habits of Mind

Exhibit A.2: The Three Aspects and Major Categories of the Science Frameworks

TIMSS 1999
Eighth Grade

Content

Earth Sciences
Life Sciences
Physical Sciences
Science, Technology, and Mathematics
Environmental Issues
Nature of Science
Science and Other Disciplines

Performance Expectations

Understanding
Theorizing, Analyzing, and Solving Problems
Using Tools, Routine Procedures and Science Processes
Investigating the Natural World
Communicating

Perspectives

Attitudes
Careers
Participation
Increasing Interest
Safety
Habits of Mind

SOURCE: IEA Third International Mathematics and Science Study (TIMSS) 1998–1999

Exhibit A.3 shows the content areas included in the 1999 mathematics test and the numbers of items and score points in each area, and Exhibit A.4 in science. Distributions are also included for the five performance categories derived from the performance expectations aspect of the curriculum framework. About one-fourth of the items were in the free-response format, requiring students to generate and write their own answers. Designed to take about one-third of students' test time, some free-response questions asked for short answers while others required extended responses with students showing their work or providing explanations for their answers. The remaining questions used a multiple-choice format. In scoring the tests, correct answers to most questions were worth one point. Consistent with the approach of allotting students longer response time for the constructed-response questions than for multiple-choice questions, however, responses to some of these questions (particularly those requiring extended responses) were evaluated for partial credit, with a fully correct answer being awarded two points. The total number of score points available for analysis thus somewhat exceeds the number of items.

Every effort was made to help ensure that the tests represented the curricula of the participating countries and that the items exhibited no bias toward or against particular countries. The final forms of the tests were endorsed by the NRCs of the participating countries.³

TIMSS Test Design

Not all of the students in the TIMSS assessment responded to all of the mathematics and science items. To ensure broad subject-matter coverage without overburdening individual students, TIMSS used a rotated design that included both the mathematics and science items. Thus, the same students participated in both the mathematics and science testing. As in 1995, the 1999 assessment consisted of eight booklets, each requiring 90 minutes of response time. Each participating student was assigned one booklet only. In accordance with the design, the mathematics and science items were assembled into 26 clusters (labeled A through Z). The secure trend items were in clusters A through H, and items replacing the released 1995 items in clusters I through Z. In all, the design provided 396 testing minutes, 198 for mathematics and 198 for science. Cluster A was a core cluster assigned to all booklets. The remaining clusters were assigned to the booklets in accordance with the rotated design so that representative samples of students responded to each cluster.⁴

3 For a full discussion of the TIMSS 1999 test development effort, please see Garden, R.A. and Smith, T.A. (2000), "TIMSS Test Development" in M.O. Martin, K.D. Gregory, K.M. O'Connor, and S.E. Stemler (eds.), *TIMSS 1999 Benchmarking Technical Report*, Chestnut Hill, MA: Boston College.

4 The 1999 TIMSS test design is identical to the design for 1995, which is fully documented in Adams, R. and Gonzalez, E. (1996), "TIMSS Test Design" in M.O. Martin and D.L. Kelly (eds.), *Third International Mathematics and Science Study Technical Report, Volume I*, Chestnut Hill, MA: Boston College.

Exhibit A.3: Distribution of Mathematics Items by Content Reporting Category and Performance Category

TIMSS 1999
Eighth Grade

| Content Category | Percentage of Items | Total Number of Items | Number of Multiple-Choice Items | Number of Free-Response Items ¹ | Number of Score Points ² |
|---|---------------------|-----------------------|---------------------------------|--|-------------------------------------|
| Fractions and Number Sense | 38 | 61 | 47 | 14 | 62 |
| Measurement | 15 | 24 | 15 | 9 | 26 |
| Data Representation, Analysis and Probability | 13 | 21 | 19 | 2 | 22 |
| Geometry | 13 | 21 | 20 | 1 | 21 |
| Algebra | 22 | 35 | 24 | 11 | 38 |
| Total | 100 | 162 | 125 | 37 | 169 |

| Performance Category | Percentage of Items | Total Number of Items | Number of Multiple-Choice Items | Number of Free-Response Items ¹ | Number of Score Points ² |
|------------------------------------|---------------------|-----------------------|---------------------------------|--|-------------------------------------|
| Knowing | 19 | 30 | 28 | 2 | 30 |
| Using Routine Procedures | 23 | 38 | 28 | 10 | 39 |
| Using Complex Procedures | 24 | 39 | 34 | 5 | 40 |
| Investigating and Solving Problems | 31 | 51 | 34 | 17 | 53 |
| Communicating and Reasoning | 2 | 4 | 1 | 3 | 7 |
| Total | 100 | 162 | 125 | 37 | 169 |

1 Free-response items include both short-answer and extended-response types.

2 In scoring the tests, correct answers to most items were worth one point. However, responses to some free-response items were evaluated for partial credit with a fully correct answer awarded up to two points. Thus, the number of score points exceeds the number of items in the test.

| Content Category | Percentage of Items | Total Number of Items | Number of Multiple-Choice Items | Number of Free-Response Items ¹ | Number of Score Points ² |
|--|---------------------|-----------------------|---------------------------------|--|-------------------------------------|
| Earth Science | 15 | 22 | 17 | 5 | 23 |
| Life Science | 27 | 40 | 28 | 12 | 42 |
| Physics | 27 | 39 | 28 | 11 | 39 |
| Chemistry | 14 | 20 | 15 | 5 | 22 |
| Environmental and Resource Issues | 9 | 13 | 7 | 6 | 14 |
| Scientific Inquiry and the Nature of Science | 8 | 12 | 9 | 3 | 13 |
| Total | 100 | 146 | 104 | 42 | 153 |

| Performance Category | Percentage of Items | Total Number of Items | Number of Multiple-Choice Items | Number of Free-Response Items ¹ | Number of Score Points ² |
|---|---------------------|-----------------------|---------------------------------|--|-------------------------------------|
| Understanding Simple Information | 39 | 57 | 56 | 1 | 57 |
| Understanding Complex Information | 31 | 45 | 30 | 15 | 47 |
| Theorizing, Analyzing and Solving Problems | 19 | 28 | 5 | 23 | 32 |
| Using Tools, Routine Procedures and Science Processes | 7 | 10 | 9 | 1 | 10 |
| Investigating the Natural World | 4 | 6 | 4 | 2 | 7 |
| Total | 100 | 146 | 104 | 42 | 153 |

1 Free response items include both short-answer and extended-response types.

2 In scoring the tests, correct answers to most items were worth one point. However, responses to some free-response items were evaluated for partial credit with a fully correct answer awarded up to two points. Thus, the number of score points exceeds the number of items in the test.

Background Questionnaires

TIMSS in 1999 administered a broad array of questionnaires to collect data on the educational context for student achievement and to measure trends since 1995. *National Research Coordinators*, with the assistance of their curriculum experts, provided detailed information on the organization, emphases, and content coverage of the mathematics and science curriculum. The *students* who were tested answered questions pertaining to their attitudes towards mathematics and science, their academic self-concept, classroom activities, home background, and out-of-school activities. The mathematics and science *teachers* of sampled students responded to questions about teaching emphasis on the topics in the curriculum frameworks, instructional practices, professional training and education, and their views on mathematics and science. The heads of *schools* responded to questions about school staffing and resources, mathematics and science course offerings, and teacher support.

Translation and Verification

The TIMSS instruments were prepared in English and translated into 33 languages, with 10 of the 38 countries collecting data in two languages. In addition, it sometimes was necessary to modify the international versions for cultural reasons, even in the nine countries that tested in English. This process represented an enormous effort for the national centers, with many checks along the way. The translation effort included (1) developing explicit guidelines for translation and cultural adaptation; (2) translation of the instruments by the national centers in accordance with the guidelines, using two or more independent translations; (3) consultation with subject-matter experts on cultural adaptations to ensure that the meaning and difficulty of items did not change; (4) verification of translation quality by professional translators from an independent translation company; (5) corrections by the national centers in accordance with the suggestions made; (6) verification by the International Study Center that corrections were made; and (7) a series of statistical checks after the testing to detect items that did not perform comparably across countries.⁵

⁵ More details about the translation verification procedures can be found in O'Connor, K., and Malak, B. (2000), "Translation and Cultural Adaptation of the TIMSS Instruments" in M.O. Martin, K.D. Gregory, K.M. O'Connor, and S.E. Stemler (eds.), *TIMSS 1999 Benchmarking Technical Report*, Chestnut Hill, MA: Boston College.

Population Definition and Sampling

TIMSS in 1995 had as its target population students enrolled in the two adjacent grades that contained the largest proportion of 13-year-old students at the time of testing, which were seventh- and eighth-grade students in most countries. TIMSS in 1999 used the same definition to identify the target grades, but assessed students in the upper of the two grades only, which was the eighth grade in most countries, including the United States.⁶ The eighth grade was the target population for all of the Benchmarking participants.

The selection of valid and efficient samples was essential to the success of TIMSS and of the Benchmarking Study. For TIMSS internationally, NRCs, as well as Westat, the sampling and data collection coordinator for TIMSS in the United States, received training in how to select the school and student samples and worked in close consultation with Statistics Canada, the TIMSS sampling consultants, on all phases of sampling. As well as conducting the sampling and data collection for the U.S. national TIMSS sample, Westat was also responsible for sampling and data collection for each of the Benchmarking participants.

To document the quality of the school and student samples in each of the TIMSS countries, staff from Statistics Canada and the International Study Center worked with the TIMSS sampling referee to review sampling plans, sampling frames, and sampling implementation. Particular attention was paid to coverage of the target population and to participation by the sampled schools and students. The data from the few countries that did not fully meet all of the sam-

pling guidelines are annotated in the TIMSS reports, and are also annotated in this report. The TIMSS samples for the Benchmarking participants were also carefully reviewed in light of the TIMSS sampling guidelines, and the results annotated where appropriate.

Although all countries and Benchmarking participants were expected to draw samples representative of the entire internationally desired population (all students in the upper of the two adjacent grades with the greatest proportion of 13-year-olds), the few countries where this was not possible were permitted to define a national desired population that excluded part of the internationally desired population. Exhibit A.5 shows any differences in coverage between the international and national desired populations. Almost all TIMSS countries achieved 100 percent coverage (36 out of 38), with Lithuania and Latvia the exceptions. Consequently, the results for Lithuania are annotated, and because coverage fell below 65 percent for Latvia, the Latvian results are labeled “Latvia (LSS),” for Latvian-Speaking Schools. Additionally, because of scheduling difficulties, Lithuania was unable to test its eighth-grade students in May 1999 as planned. Instead, the students were tested in September 1999, when they had moved into the ninth grade. The results for Lithuania are annotated to reflect this as well. Exhibit A.5 also shows that the sampling plans for all the Benchmarking participants, including Southwest Pennsylvania, incorporated 100 percent coverage of the desired population. Southwest Pennsylvania and four of the 13 states (Idaho, Indiana, Michigan, and Pennsylvania) included private schools as well as public schools.

6 The sample design for TIMSS is described in detail in Foy, P., and Joncas, M. (2000), “TIMSS Sample Design” in M.O. Martin, K.D. Gregory and S.E. Stemler (eds.), *TIMSS 1999 Technical Report*, Chestnut Hill, MA: Boston College. Sampling for the Benchmarking project is described in Fowler, J., Rizzo, L., and Rust, K. (2001), “TIMSS Benchmarking Sampling Design and Implementation” in M.O. Martin, K.D. Gregory, K.M. O’Connor, and S.E. Stemler (eds.), *TIMSS 1999 Benchmarking Technical Report*, Chestnut Hill, MA: Boston College.

In operationalizing their desired eighth-grade population, countries and Benchmarking participants could define a population to be sampled that excluded a small percentage (less than 10 percent) of certain kinds of schools or students that would be very difficult or resource-intensive to test (e.g., schools for students with special needs or schools that were very small or located in extremely rural areas). Exhibit A.5 also shows that the degree of such exclusions was small. Among countries, only Israel reached the 10 percent limit, and among Benchmarking participants, only Guilford County and Montgomery County did so. All three are annotated as such.

Within countries, TIMSS used a two-stage sample design, in which the first stage involved selecting about 150 public and private schools in each country. Within each school, countries were to use random procedures to select one mathematics class at the eighth grade. All of the students in that class were to participate in the TIMSS testing. This approach was designed to yield a representative sample of about 3,750 students per country.

States participating in the Benchmarking study were required to sample at least 50 schools and approximately 2,000 eighth-grade students. School districts and consortia were required to sample at least 25 schools and at least 1,000 students. Where there were fewer than 25 schools in a district or consortium, all schools were to be included, and the within-school sample increased to yield the total of 1,000 students.

Exhibits A.6 and A.7 present achieved sample sizes for schools and students, respectively, for the TIMSS countries and for the Benchmarking participants. In Southwest Pennsylvania, 39 of the 50 schools selected for the sample participated in the

study, with replacement schools unnecessary, for a school participation rate of 78 percent. A total of 1,538 of the 1,638 sampled students in the participating schools were assessed, for a student participation rate of 95 percent.

Exhibit A.8 shows the participation rates for schools, students, and overall, both with and without the use of replacement schools, for TIMSS countries and Benchmarking participants. All of the countries met the guideline for sampling participation – 85 percent of both the schools and students, or a combined rate (the product of school and student participation) of 75 percent – although Belgium (Flemish), England, Hong Kong, and the Netherlands did so only after including replacement schools, and are annotated accordingly. With the exception of Pennsylvania and Texas, all the Benchmarking participants met the sampling guidelines, although Indiana did so only after including replacement schools. Pennsylvania and Texas are italicized, and Indiana is annotated, to reflect these situations. The overall participation rate for Southwest Pennsylvania was 75 percent, meeting the sampling guideline.

| Countries | International Desired Population | | National Desired Population | | |
|-----------------------|----------------------------------|-----------------------------------|-----------------------------|--------------------------|--------------------|
| | Coverage | Notes on Coverage | School-Level Exclusions | Within-Sample Exclusions | Overall Exclusions |
| United States | 100% | | 0% | 4% | 4% |
| Australia | 100% | | 1% | 1% | 2% |
| Belgium (Flemish) | 100% | | 1% | 0% | 1% |
| Bulgaria | 100% | | 5% | 0% | 5% |
| Canada | 100% | | 4% | 2% | 6% |
| Chile | 100% | | 3% | 0% | 3% |
| Chinese Taipei | 100% | | 1% | 1% | 2% |
| Cyprus | 100% | | 0% | 1% | 1% |
| Czech Republic | 100% | | 5% | 0% | 5% |
| England | 100% | | 2% | 3% | 5% |
| Finland | 100% | | 3% | 0% | 4% |
| Hong Kong, SAR | 100% | | 1% | 0% | 1% |
| Hungary | 100% | | 4% | 0% | 4% |
| Indonesia | 100% | | 0% | 0% | 0% |
| Iran, Islamic Rep. of | 100% | | 4% | 0% | 4% |
| Israel | 100% | | 8% | 8% | 16% |
| Italy | 100% | | 4% | 2% | 7% |
| Japan | 100% | | 1% | 0% | 1% |
| Jordan | 100% | | 2% | 1% | 3% |
| Korea, Rep. of | 100% | | 2% | 2% | 4% |
| Latvia (LSS) | 61% | Latvian-speaking students only | 4% | 0% | 4% |
| Lithuania | 87% | Lithuanian-speaking students only | 5% | 0% | 5% |
| Macedonia, Rep. of | 100% | | 1% | 0% | 1% |
| Malaysia | 100% | | 5% | 0% | 5% |
| Moldova | 100% | | 2% | 0% | 2% |
| Morocco | 100% | | 1% | 0% | 1% |
| Netherlands | 100% | | 1% | 0% | 1% |
| New Zealand | 100% | | 2% | 1% | 2% |
| Philippines | 100% | | 3% | 0% | 3% |
| Romania | 100% | | 4% | 0% | 4% |
| Russian Federation | 100% | | 1% | 1% | 2% |
| Singapore | 100% | | 0% | 0% | 0% |
| Slovak Republic | 100% | | 7% | 0% | 7% |
| Slovenia | 100% | | 3% | 0% | 3% |
| South Africa | 100% | | 2% | 0% | 2% |
| Thailand | 100% | | 3% | 0% | 3% |
| Tunisia | 100% | | 0% | 0% | 0% |
| Turkey | 100% | | 2% | 0% | 2% |

SOURCE: IEA Third International Mathematics and Science Study (TIMSS) 1998–1999

| | International Desired Population | | National Desired Population | | |
|---------------------------------|----------------------------------|--------------------------|-----------------------------|--------------------------|--------------------|
| | Coverage | Notes on Coverage | School-Level Exclusions | Within-Sample Exclusions | Overall Exclusions |
| States | | | | | |
| Connecticut | 100% | | 0% | 5% | 5% |
| Idaho | 100% | Included Private Schools | 0% | 2% | 2% |
| Illinois | 100% | | 0% | 4% | 4% |
| Indiana | 100% | Included Private Schools | 0% | 6% | 6% |
| Maryland | 100% | | 0% | 6% | 6% |
| Massachusetts | 100% | | 0% | 5% | 5% |
| Michigan | 100% | Included Private Schools | 0% | 2% | 2% |
| Missouri | 100% | | 0% | 4% | 4% |
| North Carolina | 100% | | 0% | 4% | 4% |
| Oregon | 100% | | 0% | 5% | 5% |
| Pennsylvania | 100% | Included Private Schools | 0% | 6% | 6% |
| South Carolina | 100% | | 0% | 2% | 2% |
| Texas | 100% | | 0% | 4% | 4% |
| Districts and Consortia | | | | | |
| Academy School Dist. #20, CO | 100% | | NA | 2% | 2% |
| Chicago Public Schools, IL | 100% | | NA | 4% | 4% |
| Delaware Science Coalition, DE | 100% | | NA | 5% | 5% |
| First in the World Consort., IL | 100% | | NA | 2% | 2% |
| Fremont/Lincoln/WestSide PS, NE | 100% | | NA | 2% | 2% |
| Guilford County, NC | 100% | | NA | 10% | 10% |
| Jersey City Public Schools, NJ | 100% | | NA | 6% | 6% |
| Miami-Dade County PS, FL | 100% | | NA | 7% | 7% |
| Michigan Invitational Group, MI | 100% | | NA | 2% | 2% |
| Montgomery County, MD | 100% | | NA | 17% | 17% |
| Naperville Sch. Dist. #203, IL | 100% | | NA | 7% | 7% |
| Project SMART Consortium, OH | 100% | | NA | 2% | 2% |
| Rochester City Sch. Dist., NY | 100% | | NA | 1% | 1% |
| Southwest Pennsylvania | 100% | Included Private Schools | NA | 4% | 4% |

| Countries | Number of Schools in Original Sample | Number of Eligible Schools in Original Sample | Number of Schools in Original Sample That Participated | Number of Replacement Schools That Participated | Total Number of Schools That Participated |
|-----------------------|--------------------------------------|---|--|---|---|
| United States | 250 | 246 | 202 | 19 | 221 |
| Australia | 184 | 182 | 152 | 18 | 170 |
| Belgium (Flemish) | 150 | 150 | 106 | 29 | 135 |
| Bulgaria | 172 | 169 | 163 | 0 | 163 |
| Canada | 410 | 398 | 376 | 9 | 385 |
| Chile | 186 | 185 | 181 | 4 | 185 |
| Chinese Taipei | 150 | 150 | 150 | 0 | 150 |
| Cyprus | 61 | 61 | 61 | 0 | 61 |
| Czech Republic | 150 | 142 | 136 | 6 | 142 |
| England | 150 | 150 | 76 | 52 | 128 |
| Finland | 160 | 160 | 155 | 4 | 159 |
| Hong Kong, SAR | 180 | 180 | 135 | 2 | 137 |
| Hungary | 150 | 150 | 147 | 0 | 147 |
| Indonesia | 150 | 150 | 132 | 18 | 150 |
| Iran, Islamic Rep. of | 170 | 170 | 164 | 6 | 170 |
| Israel | 150 | 139 | 137 | 2 | 139 |
| Italy | 180 | 180 | 170 | 10 | 180 |
| Japan | 150 | 150 | 140 | 0 | 140 |
| Jordan | 150 | 147 | 146 | 1 | 147 |
| Korea, Rep. of | 150 | 150 | 150 | 0 | 150 |
| Latvia (LSS) | 150 | 148 | 143 | 2 | 145 |
| Lithuania | 150 | 150 | 150 | 0 | 150 |
| Macedonia, Rep. of | 150 | 150 | 149 | 0 | 149 |
| Malaysia | 150 | 150 | 148 | 2 | 150 |
| Moldova | 150 | 150 | 145 | 5 | 150 |
| Morocco | 174 | 174 | 172 | 1 | 173 |
| Netherlands | 150 | 148 | 86 | 40 | 126 |
| New Zealand | 156 | 156 | 145 | 7 | 152 |
| Philippines | 150 | 150 | 148 | 2 | 150 |
| Romania | 150 | 150 | 147 | 0 | 147 |
| Russian Federation | 190 | 190 | 186 | 3 | 189 |
| Singapore | 145 | 145 | 145 | 0 | 145 |
| Slovak Republic | 150 | 150 | 143 | 2 | 145 |
| Slovenia | 150 | 150 | 147 | 2 | 149 |
| South Africa | 225 | 219 | 183 | 11 | 194 |
| Thailand | 150 | 150 | 143 | 7 | 150 |
| Tunisia | 150 | 149 | 126 | 23 | 149 |
| Turkey | 204 | 204 | 202 | 2 | 204 |

SOURCE: IEA Third International Mathematics and Science Study (TIMSS) 1998–1999

| | Number of Schools in Original Sample | Number of Eligible Schools in Original Sample | Number of Schools in Original Sample That Participated | Number of Replacement Schools That Participated | Total Number of Schools That Participated |
|---------------------------------|--------------------------------------|---|--|---|---|
| States | | | | | |
| Connecticut | 54 | 54 | 52 | 0 | 52 |
| Idaho | 54 | 54 | 47 | 0 | 47 |
| Illinois | 90 | 90 | 85 | 0 | 85 |
| Indiana | 61 | 61 | 39 | 13 | 52 |
| Maryland | 79 | 77 | 73 | 0 | 73 |
| Massachusetts | 59 | 58 | 57 | 0 | 57 |
| Michigan | 66 | 62 | 55 | 2 | 57 |
| Missouri | 57 | 55 | 43 | 8 | 51 |
| North Carolina | 71 | 68 | 67 | 0 | 67 |
| Oregon | 51 | 51 | 45 | 0 | 45 |
| Pennsylvania | 116 | 113 | 80 | 0 | 80 |
| South Carolina | 53 | 53 | 49 | 0 | 49 |
| Texas | 71 | 70 | 51 | 1 | 52 |
| Districts and Consortia | | | | | |
| Academy School Dist. #20, CO | 4 | 4 | 4 | 0 | 4 |
| Chicago Public Schools, IL | 27 | 27 | 26 | 0 | 26 |
| Delaware Science Coalition, DE | 25 | 25 | 25 | 0 | 25 |
| First in the World Consort., IL | 17 | 17 | 15 | 0 | 15 |
| Fremont/Lincoln/WestSide PS, NE | 12 | 12 | 12 | 0 | 12 |
| Guilford County, NC | 17 | 17 | 17 | 0 | 17 |
| Jersey City Public Schools, NJ | 25 | 25 | 24 | 0 | 24 |
| Miami-Dade County PS, FL | 25 | 25 | 25 | 0 | 25 |
| Michigan Invitational Group, MI | 21 | 21 | 21 | 0 | 21 |
| Montgomery County, MD | 25 | 25 | 25 | 0 | 25 |
| Naperville Sch. Dist. #203, IL | 5 | 5 | 5 | 0 | 5 |
| Project SMART Consortium, OH | 24 | 24 | 24 | 0 | 24 |
| Rochester City Sch. Dist., NY | 7 | 7 | 7 | 0 | 7 |
| Southwest Pennsylvania | 50 | 49 | 39 | 0 | 39 |

| Countries | Within-School Student Participation (Weighted Percentage) | Number of Sampled Students in Participating Schools | Number of Students Withdrawn from Class/School | Number of Students Excluded | Number of Eligible Students | Number of Students Absent | Number of Students Assessed |
|-----------------------|---|---|--|-----------------------------|-----------------------------|---------------------------|-----------------------------|
| United States | 94% | 9981 | 115 | 142 | 9724 | 652 | 9072 |
| Australia | 90% | 4600 | 96 | 53 | 4451 | 419 | 4032 |
| Belgium (Flemish) | 97% | 5387 | 12 | 0 | 5375 | 116 | 5259 |
| Bulgaria | 96% | 3461 | 63 | 0 | 3398 | 126 | 3272 |
| Canada | 96% | 9490 | 84 | 245 | 9161 | 391 | 8770 |
| Chile | 96% | 6283 | 119 | 18 | 6146 | 239 | 5907 |
| Chinese Taipei | 99% | 5889 | 30 | 42 | 5817 | 45 | 5772 |
| Cyprus | 97% | 3296 | 38 | 32 | 3226 | 110 | 3116 |
| Czech Republic | 96% | 3640 | 24 | 0 | 3616 | 163 | 3453 |
| England | 90% | 3400 | 27 | 115 | 3258 | 298 | 2960 |
| Finland | 96% | 3060 | 17 | 13 | 3030 | 110 | 2920 |
| Hong Kong, SAR | 98% | 5310 | 18 | 1 | 5291 | 112 | 5179 |
| Hungary | 95% | 3350 | 0 | 0 | 3350 | 167 | 3183 |
| Indonesia | 97% | 6162 | 106 | 1 | 6055 | 207 | 5848 |
| Iran, Islamic Rep. of | 98% | 5497 | 104 | 0 | 5393 | 92 | 5301 |
| Israel | 94% | 4670 | 29 | 187 | 4454 | 259 | 4195 |
| Italy | 97% | 3531 | 23 | 86 | 3422 | 94 | 3328 |
| Japan | 95% | 4996 | 15 | 12 | 4969 | 224 | 4745 |
| Jordan | 99% | 5300 | 130 | 42 | 5128 | 76 | 5052 |
| Korea, Rep. of | 100% | 6285 | 29 | 128 | 6128 | 14 | 6114 |
| Latvia (LSS) | 93% | 3128 | 16 | 4 | 3108 | 235 | 2873 |
| Lithuania | 89% | 2668 | 0 | 0 | 2668 | 307 | 2361 |
| Macedonia, Rep. of | 98% | 4096 | 0 | 0 | 4096 | 73 | 4023 |
| Malaysia | 99% | 5713 | 98 | 0 | 5615 | 38 | 5577 |
| Moldova | 98% | 3824 | 23 | 0 | 3801 | 90 | 3711 |
| Morocco | 92% | 5841 | 42 | 0 | 5799 | 397 | 5402 |
| Netherlands | 95% | 3099 | 12 | 0 | 3087 | 125 | 2962 |
| New Zealand | 94% | 3966 | 96 | 22 | 3848 | 235 | 3613 |
| Philippines | 92% | 7591 | 461 | 0 | 7130 | 529 | 6601 |
| Romania | 98% | 3514 | 36 | 0 | 3478 | 53 | 3425 |
| Russian Federation | 97% | 4557 | 48 | 34 | 4475 | 143 | 4332 |
| Singapore | 98% | 5100 | 37 | 0 | 5063 | 97 | 4966 |
| Slovak Republic | 98% | 3695 | 149 | 0 | 3546 | 49 | 3497 |
| Slovenia | 95% | 3287 | 0 | 4 | 3283 | 174 | 3109 |
| South Africa | 93% | 9071 | 256 | 0 | 8815 | 669 | 8146 |
| Thailand | 99% | 5831 | 59 | 0 | 5772 | 40 | 5732 |
| Tunisia | 98% | 5189 | 45 | 0 | 5144 | 93 | 5051 |
| Turkey | 99% | 7972 | 49 | 0 | 7923 | 82 | 7841 |

SOURCE: IEA Third International Mathematics and Science Study (TIMSS) 1998-1999

| | Within-School Student Participation (Weighted Percentage) | Number of Sampled Students in Participating Schools | Number of Students Withdrawn from Class/School | Number of Students Excluded | Number of Eligible Students | Number of Students Absent | Number of Students Assessed |
|---------------------------------|---|---|--|-----------------------------|-----------------------------|---------------------------|-----------------------------|
| States | | | | | | | |
| Connecticut | 94% | 2190 | 6 | 43 | 2141 | 124 | 2023 |
| Idaho | 95% | 1968 | 17 | 27 | 1924 | 94 | 1847 |
| Illinois | 96% | 5144 | 30 | 136 | 4978 | 227 | 4781 |
| Indiana | 95% | 2175 | 9 | 27 | 2139 | 102 | 2046 |
| Maryland | 94% | 3877 | 21 | 339 | 3517 | 221 | 3317 |
| Massachusetts | 95% | 2538 | 18 | 54 | 2466 | 131 | 2353 |
| Michigan | 96% | 2811 | 7 | 44 | 2760 | 143 | 2623 |
| Missouri | 94% | 2147 | 27 | 40 | 2080 | 128 | 1979 |
| North Carolina | 94% | 3502 | 34 | 191 | 3277 | 214 | 3097 |
| Oregon | 93% | 2044 | 24 | 29 | 1991 | 126 | 1889 |
| Pennsylvania | 95% | 3463 | 18 | 60 | 3385 | 167 | 3236 |
| South Carolina | 94% | 2177 | 18 | 36 | 2123 | 130 | 2011 |
| Texas | 93% | 2189 | 18 | 44 | 2127 | 149 | 1996 |
| Districts and Consortia | | | | | | | |
| Academy School Dist. #20, CO | 94% | 1329 | 0 | 15 | 1314 | 81 | 1233 |
| Chicago Public Schools, IL | 94% | 1227 | 13 | 21 | 1193 | 74 | 1132 |
| Delaware Science Coalition, DE | 92% | 1389 | 16 | 18 | 1355 | 103 | 1268 |
| First in the World Consort., IL | 96% | 782 | 1 | 2 | 779 | 30 | 750 |
| Fremont/Lincoln/WestSide PS, NE | 95% | 1178 | 20 | 25 | 1133 | 60 | 1093 |
| Guilford County, NC | 92% | 1215 | 17 | 121 | 1077 | 76 | 1018 |
| Jersey City Public Schools, NJ | 94% | 1116 | 5 | 47 | 1064 | 65 | 1004 |
| Miami-Dade County PS, FL | 91% | 1356 | 23 | 10 | 1323 | 117 | 1229 |
| Michigan Invitational Group, MI | 91% | 994 | 0 | 11 | 983 | 80 | 903 |
| Montgomery County, MD | 94% | 1481 | 13 | 254 | 1214 | 72 | 1155 |
| Naperville Sch. Dist. #203, IL | 96% | 1343 | 9 | 84 | 1250 | 47 | 1212 |
| Project SMART Consortium, OH | 94% | 1188 | 11 | 18 | 1159 | 74 | 1096 |
| Rochester City Sch. Dist., NY | 84% | 1165 | 8 | 9 | 1148 | 190 | 966 |
| Southwest Pennsylvania | 95% | 1638 | 14 | 21 | 1603 | 79 | 1538 |

| Countries | School Participation | | Student Participation | Overall Participation | |
|-----------------------|----------------------|-------------------|-----------------------|-----------------------|-------------------|
| | Before Replacement | After Replacement | | Before Replacement | After Replacement |
| United States | 83% | 90% | 94% | 78% | 85% |
| Australia | 83% | 93% | 90% | 75% | 84% |
| Belgium (Flemish) | 72% | 89% | 97% | 70% | 87% |
| Bulgaria | 97% | 97% | 96% | 93% | 93% |
| Canada | 92% | 95% | 96% | 88% | 92% |
| Chile | 98% | 100% | 96% | 94% | 96% |
| Chinese Taipei | 100% | 100% | 99% | 99% | 99% |
| Cyprus | 100% | 100% | 97% | 97% | 97% |
| Czech Republic | 94% | 100% | 96% | 90% | 96% |
| England | 49% | 85% | 90% | 45% | 77% |
| Finland | 97% | 100% | 96% | 93% | 96% |
| Hong Kong, SAR | 75% | 76% | 98% | 74% | 75% |
| Hungary | 98% | 98% | 95% | 93% | 93% |
| Indonesia | 84% | 100% | 97% | 81% | 97% |
| Iran, Islamic Rep. of | 96% | 100% | 98% | 95% | 98% |
| Israel | 98% | 100% | 94% | 93% | 94% |
| Italy | 94% | 100% | 97% | 91% | 97% |
| Japan | 93% | 93% | 95% | 89% | 89% |
| Jordan | 99% | 100% | 99% | 98% | 99% |
| Korea, Rep. of | 100% | 100% | 100% | 100% | 100% |
| Latvia (LSS) | 96% | 98% | 93% | 89% | 91% |
| Lithuania | 100% | 100% | 89% | 89% | 89% |
| Macedonia, Rep. of | 99% | 99% | 98% | 98% | 98% |
| Malaysia | 99% | 100% | 99% | 98% | 99% |
| Moldova | 96% | 100% | 98% | 94% | 98% |
| Morocco | 99% | 99% | 92% | 91% | 92% |
| Netherlands | 62% | 85% | 95% | 59% | 81% |
| New Zealand | 93% | 97% | 94% | 87% | 91% |
| Philippines | 98% | 100% | 92% | 91% | 92% |
| Romania | 98% | 98% | 98% | 97% | 97% |
| Russian Federation | 98% | 100% | 97% | 95% | 97% |
| Singapore | 100% | 100% | 98% | 98% | 98% |
| Slovak Republic | 95% | 96% | 98% | 93% | 94% |
| Slovenia | 98% | 99% | 95% | 93% | 94% |
| South Africa | 85% | 91% | 93% | 79% | 84% |
| Thailand | 93% | 100% | 99% | 93% | 99% |
| Tunisia | 84% | 100% | 98% | 82% | 98% |
| Turkey | 99% | 100% | 99% | 98% | 99% |

SOURCE: IEA Third International Mathematics and Science Study (TIMSS) 1998–1999

| | School Participation | | Student Participation | Overall Participation | |
|---------------------------------|----------------------|-------------------|-----------------------|-----------------------|-------------------|
| | Before Replacement | After Replacement | | Before Replacement | After Replacement |
| States | | | | | |
| Connecticut | 96% | 96% | 94% | 90% | 90% |
| Idaho | 88% | 88% | 95% | 83% | 83% |
| Illinois | 95% | 95% | 96% | 91% | 91% |
| Indiana | 61% | 83% | 95% | 58% | 79% |
| Maryland | 94% | 94% | 94% | 88% | 88% |
| Massachusetts | 98% | 98% | 95% | 93% | 93% |
| Michigan | 89% | 92% | 96% | 85% | 88% |
| Missouri | 79% | 94% | 94% | 75% | 88% |
| North Carolina | 98% | 98% | 94% | 92% | 92% |
| Oregon | 89% | 89% | 93% | 83% | 83% |
| Pennsylvania | 66% | 66% | 95% | 63% | 63% |
| South Carolina | 92% | 92% | 94% | 86% | 86% |
| Texas | 73% | 74% | 93% | 67% | 69% |
| Districts and Consortia | | | | | |
| Academy School Dist. #20, CO | 100% | 100% | 94% | 94% | 94% |
| Chicago Public Schools, IL | 95% | 95% | 94% | 90% | 90% |
| Delaware Science Coalition, DE | 100% | 100% | 92% | 92% | 92% |
| First in the World Consort., IL | 93% | 93% | 96% | 90% | 90% |
| Fremont/Lincoln/WestSide PS, NE | 100% | 100% | 95% | 95% | 95% |
| Guilford County, NC | 100% | 100% | 92% | 92% | 92% |
| Jersey City Public Schools, NJ | 97% | 97% | 94% | 91% | 91% |
| Miami-Dade County PS, FL | 100% | 100% | 91% | 91% | 91% |
| Michigan Invitational Group, MI | 100% | 100% | 91% | 91% | 91% |
| Montgomery County, MD | 100% | 100% | 94% | 94% | 94% |
| Naperville Sch. Dist. #203, IL | 100% | 100% | 96% | 96% | 96% |
| Project SMART Consortium, OH | 100% | 100% | 94% | 94% | 94% |
| Rochester City Sch. Dist., NY | 100% | 100% | 84% | 84% | 84% |
| Southwest Pennsylvania | 78% | 78% | 95% | 75% | 75% |

Data Collection

Each participating country was responsible for carrying out all aspects of the data collection, using standardized procedures developed for the study. Training manuals were created for school coordinators and test administrators that explained procedures for receipt and distribution of materials as well as for the activities related to the testing sessions. These manuals covered such things as procedures for test security, standardized scripts to regulate directions and timing, and rules for answering students' questions. As the data collection contractor for the U.S. national TIMSS, Westat was fully acquainted with the TIMSS procedures, and applied them in each of the Benchmarking jurisdictions in the same way as in the national data collection.

Each country was responsible for conducting quality control procedures and describing this effort in the NRC's report documenting procedures used in the study. In addition, the International Study Center considered it essential to monitor compliance with standardized procedures through an international program of quality control site visits. NRCs were asked to nominate one or more persons unconnected with their national center, such as retired school teachers, to serve as quality control monitors for their countries. The International Study Center developed manuals for the monitors and briefed them in two-day training sessions about TIMSS and their roles and responsibilities.

The international quality control monitors interviewed the NRCs about data collection plans and procedures. They also visited a sample of 15 schools where they observed testing sessions and interviewed school coordinators.⁷ Quality control monitors interviewed school coordinators in all 38 countries, and observed a total of 550 testing sessions. The results of the interviews conducted by the international quality control monitors indicated that, in general, NRCs had prepared well for data collection and were able to conduct it efficiently and professionally. Similarly, the TIMSS tests appeared to have been administered in compliance with international procedures, including the activities before the testing session, those during testing, and the school-level activities related to receiving, distributing, and returning material from the national centers.

As a parallel quality control effort for the Benchmarking project, the International Study Center recruited and trained a team of 18 quality control observers, and sent them to observe the data collection activities of the Westat test administrators in a sample of about 10 percent of the schools in the study (98 schools in all).⁸ In line with the experience internationally, the observers reported that the data collection was conducted successfully according to the prescribed procedures, and that no serious problems were encountered.

7 Steps taken to ensure high-quality data collection in TIMSS internationally are described in detail in O'Connor, K., and Stemler, S. (2000), "Quality Control in the TIMSS Data Collection" in M.O. Martin, K.D. Gregory and S.E. Stemler (eds.), *TIMSS 1999 Technical Report*, Chestnut Hill, MA: Boston College.

8 Quality control measures for the Benchmarking project are described in O'Connor, K. and Stemler, S. (2001), "Quality Control in the TIMSS Benchmarking Data Collection" in M.O. Martin, K.D. Gregory, K.M. O'Connor, and S.E. Stemler (eds.), *TIMSS 1999 Benchmarking Technical Report*, Chestnut Hill, MA: Boston College.

Scoring the Free-Response Items

Because about one-third of the written test time was devoted to free-response items, TIMSS needed to develop procedures for reliably evaluating student responses within and across countries.

Scoring used two-digit codes with rubrics specific to each item. The first digit designates the correctness level of the response. The second digit, combined with the first, represents a diagnostic code identifying specific types of approaches, strategies, or common errors and misconceptions.

To ensure reliable scoring procedures based on the TIMSS rubrics, the International Study Center prepared detailed guides containing the rubrics and explanations of how to implement them, together with example student responses for the various rubric categories. These guides, along with training packets containing extensive examples of student responses for practice in applying the rubrics, were used as a basis for intensive training in scoring the free-response items. The training sessions were designed to help representatives of national centers who would then be responsible for training personnel in their countries to apply the two-digit codes reliably. In the United States, the scoring was conducted by National Computer Systems (NCS) under contract to Westat. To ensure that student responses from the Benchmarking participants were scored in the same way as those from the U.S. national sample, NCS had both sets of data scored at the same time and by the same scoring staff. TIMSS conducted reliability studies that indicated the scoring procedures were robust for the mathematics and science items, especially for the correctness score.

Data Processing

To ensure the availability of comparable, high-quality data for analysis, TIMSS took rigorous quality control steps to create the international database.⁹ TIMSS prepared manuals and software for countries to use in entering their data, so that the information would be in a standardized international format before being forwarded to the IEA Data Processing Center for creation of the international database. Upon arrival at the Data Processing Center, the data underwent an exhaustive cleaning process. This involved several iterative steps and procedures designed to identify, document, and correct deviations from the international instruments, file structures, and coding schemes. The process also emphasized consistency of information within national data sets and appropriate linking among the many student, teacher, and school data files. In the United States, the creation of the data files for both the Benchmarking participants and the U.S. national TIMSS effort was the responsibility of Westat, working closely with NCS. After the data files were checked carefully by Westat, they were sent to the IEA Data Processing Center, where they underwent further validity checks before being forwarded to the International Study Center.

⁹ These steps are detailed in Hastedt, D., and Gonzalez, E. (2000), "Data Management and Database Construction" in M.O. Martin, K.D. Gregory, K.M. O'Connor, and S.E. Stemler (eds.), *TIMSS 1999 Benchmarking Technical Report*, Chestnut Hill, MA: Boston College.

International Benchmarks of Student Achievement

International benchmarks of student achievement were computed for both mathematics and science. The benchmarks are points in the weighted international distribution of achievement scores that separate the 10 percent of students located on top of the distribution, the top 25 percent of students, the top 50 percent, and the bottom 25 percent. That is, the benchmarks correspond to the 90th, 75th, 50th, and 25th percentiles of the international distribution of achievement. When computing these percentiles, each country contributed as many students to the distribution as there were students in the target population in the country. That is, each country's contribution to setting the international benchmarks was proportional to the estimated population enrolled at the eighth grade.

Development of the Benchmark Descriptions

To develop descriptions of achievement at the TIMSS 1999 international benchmarks, the International Study Center at Boston College used the scale anchoring method. Scale anchoring is a way of describing students' performance at different points on the TIMSS 1999 achievement scale in terms of what they know and can do as evidenced by the types of items they answered correctly. It involves an empirical component in which items that discriminate between successive points on the scale are iden-

tified, and a judgmental component in which subject-matter experts examine the content of the items and generalize to students' knowledge and understandings.¹⁰

For the scale anchoring analysis, the results of students from all the TIMSS 1999 countries were pooled, so that the benchmark descriptions refer to all students achieving at that level. (That is, it does not matter which country the students are from, only how they performed on the test.) Certain criteria were applied to the TIMSS 1999 achievement scale results to identify the sets of items that students reaching each international benchmark were likely to answer correctly and those at the next lower benchmark were unlikely to answer correctly.¹¹ The sets of items thus produced represented the accomplishments of students reaching each benchmark and were used by a panel of subject-matter experts from the TIMSS countries to develop the benchmark descriptions. The work of the panel involved developing a short description for each item of the understandings demonstrated by students answering it correctly, summarizing students' knowledge and understandings across the set of items for each benchmark to provide more general statements of achievement, and selecting example items illustrating the descriptions.

10 The scale anchoring procedure is described fully in Gregory, K., and Mullis, I. (2000), "Describing International Benchmarks of Student Achievement" in M.O. Martin, K.D. Gregory, K.M. O'Connor, and S.E. Stemler (eds.), *TIMSS 1999 Benchmarking Technical Report*, Chestnut Hill, MA: Boston College.

11 For example, for the Top 10% Benchmark, an item was included if at least 65 percent of students scoring at the scale point corresponding to this benchmark answered the item correctly and less than 50 percent of students scoring at the Upper Quarter Benchmark answered it correctly. Similarly, for the Upper Quarter Benchmark, an item was included if at least 65 percent of students scoring at that point answered the item correctly and less than 50 percent of students at the Median Benchmark answered it correctly.

Interpreting the Benchmark Descriptions

In general, the parts of the descriptions that relate to the understanding of mathematics and science concepts, to skills, or to familiarity with procedures are relatively straightforward. It needs to be acknowledged, however, that the cognitive behavior necessary to answer some items correctly may vary according to students' experience. An item may require only simple recall for a student familiar with the item's content and context, but necessitate problem-solving strategies from one unfamiliar with the material. Nevertheless, the descriptions are based on what the panel believed to be the way the great majority of eighth-grade students could be expected to perform.

It also needs to be emphasized that the descriptions of achievement characteristic of students at the international benchmarks are based solely on student performance on the TIMSS 1999 items. Since those items were developed in particular to sample the mathematics and science domains prescribed for this study, neither the set of items nor the descriptions based on them purport to be comprehensive. There are undoubtedly other mathematics and science curriculum elements on which students at the various benchmarks would have been successful if they had been included in the assessment.

Please note that students reaching a particular benchmark demonstrated the knowledge and understandings characterizing that benchmark as well as those characterizing the lower benchmarks. The description of achievement at each benchmark is cumulative, building on the description of achievement demonstrated by students at the lower benchmarks.

Finally, it must be emphasized that the descriptions of the international benchmarks are one possible way of beginning to examine student performance. Some students scoring below a benchmark may indeed know or understand some of the concepts that characterize a higher level. Thus, it is important to consider performance on the individual items and clusters of items in developing a profile of student achievement.

Additional Information

Additional procedural and technical information, including that on scaling and data analysis, sampling error, and tests of statistical significance, can be found in appendix A of the full Benchmarking reports and in the *TIMSS 1999 Benchmarking Technical Report*.

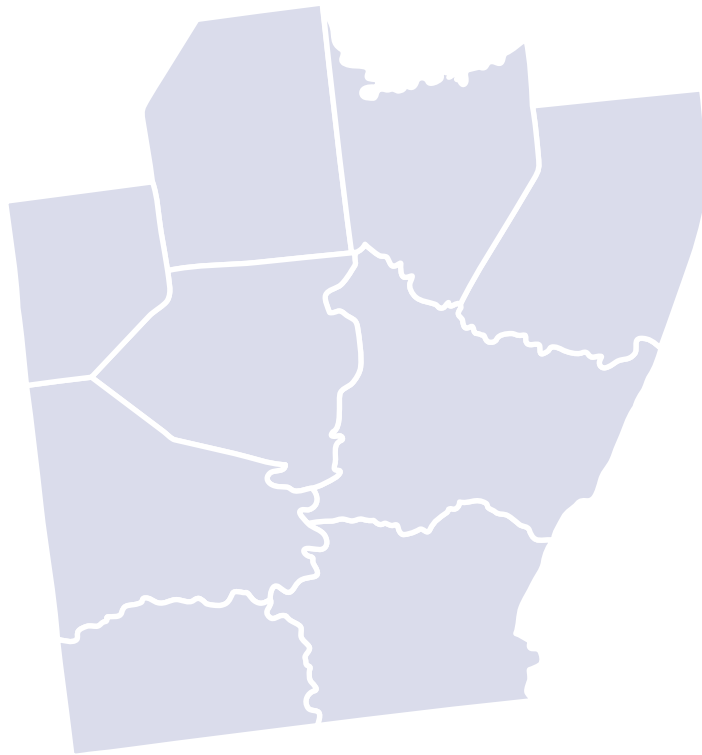

Appendix B

Resources for Further Information: Contacts and Exemplary Materials



Allegheny Conference on Community Development
425 Sixth Avenue, Suite 1000
Pittsburgh, PA 15129
412-281-1890
www.accdpel.org

Allegheny Policy Council (EpiCenter)
425 Sixth Avenue, Suite 340
Pittsburgh, PA 15219-1819
412-281-2000
www.epi-center.org

ASSET Incorporated
290 Corliss Street
Center City Terminal
Pittsburgh, PA 15220
412-771-2121
www.ASSET-Science.org

Arts Education Collaborative
Regional Enterprise Tower
425 Sixth Avenue, Suite 2650
Pittsburgh, PA 15219-1819
412-201-7400
tambuccis@collaboratives.org

Cognitive Tutor
Carnegie Learning
1200 Penn Avenue, Suite 150
Pittsburgh, PA 15222
412-690-2442
info@carnegielearning.com
www.carnegielearning.com

College in High School
B-4 Thaw Hall
Pittsburgh, PA 15260
412-624-6789
batt@pitt.edu
www.pitt.edu/~chsp

Curriculum Focal Point
Carnegie Science Center
One Allegheny Avenue
Pittsburgh, PA 15212
412-237-1535
davisj@csc.clpgh.org
www.carnegiesciencecenter.org

DASH/FAST
Carnegie Mellon Center for University Outreach
4902 Forbes Avenue
Campus Box 6259
Pittsburgh, PA 15227
412-268-1498
jh4p@andrew.cmu.edu
www.outreach.mac.cc.cmu.edu/cuo/index.html

Focus on Conceptual Understanding in Science
Math & Science Collaborative
Regional Enterprise Tower
425 Sixth Avenue, Suite 2650
Pittsburgh, PA 15219-1819
412-201-7416
tamlrl@collaboratives.org
www.msc.collaboratives.org

Girls, Math and Science
Family Communications, Inc.
4802 Fifth Avenue
Pittsburgh, PA 15213
412-687-2990 ext. 228
gms@fci.org

International Study Center
Boston College
Lynch School of Education
Manresa House
140 Commonwealth Avenue
Chestnut Hill, MA 02467
617-552-1600
<http://timss.bc.edu>

Math & Science Collaborative
Regional Enterprise Tower
425 Sixth Avenue, Suite 2650
Pittsburgh, PA 15219-1819
412-201-7416
tamlerl@collaboratives.org
www.msc.collaboratives.org

National Center for Education Statistics
Office of Educational Research and Improvement
1990 K Street, NW
Washington, DC 20006
202-502-7300
<http://www.ed.gov/NCES/timss>

National Science Education Standards
National Academy of Sciences
2101 Constitution Avenue, NW
Washington, DC 20418
www.nas.edu

National Science Foundation
4201 Wilson Boulevard
Arlington, VA 22230
703-292-5111
www.nsf.gov

Pennsylvania School Boards Association
774 Limekiln Road
New Cumberland, PA 17070-2398
717-774-2331
www.psba.org

Pennsylvania Science Teachers Association
103 Fifth Street
Towanda, PA 18848
607-777-4176
www.pascience.org

Pittsburgh: The Story of an American City
5th Edition - 1999
Stefan Lorant
Esselmont Books, LLC

Principles and Standards for School Mathematics
National Council for Teachers of Mathematics
NCTM Headquarters Office
1906 Association Drive
Reston, VA 20191-9988
703-620-9840
infocentral@nctm.org
www.nctm.org

Regional Mathematics Curriculum Framework
Allegheny Intermediate Unit
1400 Penn Avenue, Suite 201
Pittsburgh, PA 15222
412-394-5867
miller@aiu3.net
www.aiu3.net

Research for Better Schools
444 North Third Street
Philadelphia, PA 19123
215-574-9300
info@rbs.org
www.rbs.org

Resources for Educators Database
Collaboratives for Learning
Regional Enterprise Tower
425 Sixth Avenue, Suite 2650
Pittsburgh, PA 15219-1819
412-201-7400
goodingd@collaboratives.org
www.pa-edresources.net

School Performance Network
Regional Enterprise Tower
425 Sixth Avenue, Suite 2650
Pittsburgh, PA 15219-1819
412-201-7400
haydenmc@collaboratives.org
www.schoolperformance.net

Secondary Mathematics Project
Math & Science Collaborative
Regional Enterprise Tower
425 Sixth Avenue, Suite 2650
Pittsburgh, PA 15219-1819
412-201-7409
seeleym@collaboratives.org
www.msc.collaboratives.org

The Teaching Gap
James W. Stigler and James Hiebert
The Free Press
Simon and Schuster
www.SimonSays.com

US TIMSS National Research Center
Michigan State University
College of Education
455 Erickson Hall
East Lansing, MI 48824-1034
517-353-7755
<http://ustimms.msu.edu>

What's the Big Idea?
Math and Science Collaborative
Regional Enterprise Tower
425 Sixth Avenue, Suite 2650
Pittsburgh, PA 15219-1819
412-201-7409
seeleym@collaboratives.org
www.msc.collaboratives.org

A Representative Sample of Research-Based Curriculum Materials

| Name | Publisher | Website |
|--|---|---|
| Elementary School Science | | |
| BSCS Science T.R.A.C.S. | Kendall/Hunt & Publishing | http://www.bscs.org/cp_el_tracs.html |
| Developmental Approaches in Science, Health, and Technology (DASH) | Curriculum Research and Development Group, University of Hawaii | http://outreach.mac.cc.cmu.edu/DASH/ |
| Full Option Science Systems (FOSS) | Delta Education, Inc. | www.delta-ed.com/teachers/science/foss.html |
| Insights | Kendall/Hunt & Publishing | http://www.kendallhunt.com/elhi |
| Science and Technology for Children (STC) | Carolina Biological Supply Co. | www.carosci.com/stc.htm |
| Middle School Science | | |
| ARIES: Astronomy-Based Physical Science | Charlesbridge Publishing | http://www.charlesbridge.com/school/instruction/mathsci/aries/home.htm |
| BSCS Middle School Science & Technology | Kendall/Hunt & Publishing | http://www.bscs.org/cp_ms_book.html |
| Event Based Science | Montgomery County Public Schools | http://www.mcps.k12.md.us/departments/eventsci |
| Foundational Approaches to Science Teaching (FAST) | Curriculum Research and Development Group, University of Hawaii | http://outreach.mac.cc.cmu.edu/DASH/ |
| Full Option Science Systems (FOSS) for Middle School | Delta Education, Inc. | http://www.delta-ed.com/teachers/middle/foss.html |
| Investigating Earth Systems (IES) | It's About Time Publishing Co | http://www.its-about-time.com/htmls/ies.html |
| Prime Science Middle School | Kendall/Hunt & Publishing | http://www.kendallhunt.com/elhi |
| Science and Life Issues (SALI) | Lab-Aids, Inc. | http://www.lhs.berkeley.edu/sepup/salioutlinecomm.html |
| Science and Technology Concepts for Middle Schools (STC/MS) | Carolina Biological Supply Co. | www.carosci.com/stc.htm |
| Science 2000+ | Kendall/Hunt & Publishing | http://www.kendallhunt.com/elhi |
| Science Education for Public Understanding Program (SEPUP) | Lab-Aids, Inc. | http://www.lhs.berkeley.edu/sepup/ |

| Name | Publisher | Website |
|---|---|---|
| High School Science | | |
| Earth System Science in the Community (EarthComm) | It's About Time Publishing Co. | http://www.its-about-time.com/htmls/ec.html |
| Active Physics | It's About Time Publishing Co. | http://www.its-about-time.com/htmls/ap.html |
| Chemistry in the Community (ChemCom) | W.H. Freeman and Co. | http://chemistry.org/portal/Chemistry?PID=acsdisplay.html&DOC=education%5Ccurriculum%5Cchemcom.html |
| Comprehensive Conceptual Curriculum for Physics (C3P) | Department of Physics, University of Dallas | http://phys.udallas.edu/ |
| Introductory Physical Science (IPS) | Science Curriculum, Inc. | http://www.sci-ips.com/ |
| Minds-On Physics | Kendall/Hunt Publishing | http://www.kendallhunt.com/elhi |
| Biology: A Community Context | Glencoe/McGraw-Hill | http://www.sra4kids.com/everydaylearning/bcc/index.html |
| BSCS Biology: A Human Approach | Kendall/Hunt Publishing | http://www.bscs.org/cp_hs_ha.html |
| BSCS Biology: A Molecular Approach (Blue Version) | Glencoe/McGraw-Hill | http://www.bscs.org/cp_hs_mol.html |
| BSCS Biology: An Ecological Approach (Green Version) | Kendall/Hunt Publishing | http://www.bscs.org/cp_hs_eco.html |
| Insights in Biology | Kendall/Hunt Publishing | http://www.kendallhunt.com/elhi/ |
| Chem Discovery | Kendall/Hunt Publishing | http://www.kendallhunt.com/elhi/ |
| Ecology: A Systems Approach | Kendall/Hunt Publishing | http://www.kendallhunt.com/elhi/ |
| Prime Science High School | Kendall/Hunt Publishing | http://www.kendallhunt.com/elhi |
| Science in a Technical World | W.H. Freeman and Co. | http://www.whfreeman.com/stw/ |
| Issues, Evidence and You (IEY) | Lab-Aids, Inc. | http://www.lhs.berkeley.edu/sepup/ieyoverview.html |
| Science and Sustainability (S&S) | Lab-Aids, Inc. | http://www.lhs.berkeley.edu/SEPUP/scisus.html |

Elementary School Mathematics

| | | |
|---|-------------------------|---|
| Everyday Mathematics | SRA/McGraw-Hill | www.everydaylearning.com/em/index.html |
| Growing with Mathematics | Mimosa Publications | http://www.dac.neu.edu/cesame/mimosa~1.htm |
| Investigations in Number, Data, and Space | Scott Foresman | http://www.lab.brown.edu/investigations/ |
| Math Trailblazers | Kendall/Hunt Publishing | www.math.uic.edu/IMSE/MTB/mtb.html |

| Name | Publisher | Website |
|----------------------------------|---------------------------|---|
| Middle School Mathematics | | |
| Connected Mathematics Project | Prentice Hall | www.phschool.com/math/cmp/index.html |
| Mathematics in Context | Encyclopedia Britannica | www.ebmic.com/ebec/index.htm |
| MathScape | Glencoe/McGraw-Hill | http://www2.edc.org/MathscapeSTM/ |
| MATHematics | McDougal Littell | http://showmecenter.missouri.edu/showme/stem.shtml |
| Pathways to Algebra and Geometry | Voyager Expanded Learning | http://mmap.wested.org/pathways/ |

High School Mathematics

| | | |
|--|--------------------------------|---|
| Cognitive Tutor Algebra | Carnegie Learning, Inc. | http://www.carnegielearning.com/ |
| Contemporary Mathematics in Context | Glencoe/McGraw-Hill | www.wmich.edu/cpmp/ |
| Contemporary Precalculus Through Applications | Glencoe/McGraw-Hill | http://www.dac.neu.edu/cesame/cpa~1.htm |
| Interactive Mathematics Program | Key Curriculum Press | http://www.keypress.com/catalog/products/textbooks/Prod_IMP.html |
| MATH Connections: A Secondary Mathematics Core Curriculum | It's About Time Publishing Co. | www.mathconnections.com |
| Mathematics: Modeling Our World | W.H. Freeman and Co. | http://www.comap.com/highschool/projects/mmow/introduction.htm |
| SIMMS Integrated Mathematics: A Modeling Approach Using Technology | Pearson Custom Publishing | http://www.edc.org/mcc/csimms.htm |

Appendix C

Acknowledgments



Southwest Pennsylvania Regional Benchmarking Report, TIMSS 1999 – Eighth Grade Mathematics and Science: Achievement for a Workforce Region in a National and International Context was primarily a collaborative effort of the TIMSS International Study Center (ISC) of the Lynch School of Education at Boston College and the Math & Science Collaborative (MSC) of Southwest Pennsylvania. However, this report is a secondary analysis of TIMSS 1999 and the TIMSS 1999 Benchmarking Study, which themselves were collaborative efforts among hundreds of individuals around the world. Staff from the national research centers in each participating country and from each Benchmarking jurisdiction, the International Association for the Evaluation of Educational Achievement (IEA), advisors, and funding agencies worked closely to develop and implement the projects. They would not have been possible without the tireless efforts of all involved. Below, many individuals and organizations are acknowledged for their contributions. Given that implementing the studies has spanned approximately four years, and the secondary analysis of the resulting data continues, and that both involve so many people and organizations, this list cannot pay heed to all who contributed throughout the life of the project. Any omission is inadvertent. The Math & Science Collaborative and the International Study Center especially want to acknowledge the students, teachers, and school principals who contributed their time and effort to the study, and whose confidentiality is respected. This report would not be possible without them.

Funding Agencies

Each Benchmarking participant contracted directly with Boston College to fund data-collection activities in its own jurisdiction. The funds for Southwest Pennsylvania were raised through the Math & Science Collaborative with the assistance of the Working Together Consortium. Its Vice Chair for Human Capital, Jane Burger, seized the Benchmarking opportunity as a worthy initiative for the region's data collection efforts. Substantial contributions earmarked for TIMSS Benchmarking participation were made by the Buhl Foundation, Giant Eagle, Inc., The Grable Foundation, The Vira I. Heinz Endowment, The Richard King Mellon Foundation, and Charles Queenan. They were also joined in providing general support for the Math & Science Collaborative by ALCOA Foundation, Bayer Foundation, Bell Atlantic Foundation, Benedum Foundation, the Fisher Fund of the Pittsburgh Foundation, the Henry C. Frick Educational Fund of the Buhl Foundation, the Hillman Foundation, Mellon Financial Corporation, the Mid-Atlantic Eisenhower Consortium, People's Gas, PNC Bank Foundation, PPG Industries Foundation, and Westinghouse Foundation.

Funding for the international coordination of TIMSS 1999 was provided by the National Center for Education Statistics (NCES) in the U.S. Department of Education, the U.S. National Science Foundation (NSF), the World Bank, and participating countries. Funding for the overall design, administration, data management, and quality assurance activities of TIMSS Benchmarking was provided by NCES, NSF, and the Office of Educational Research and Improvement (OERI) in the U.S. Department of Education. Valena Plisko,

Eugene Owen, and Patrick Gonzales of NCES; Janice Earle, Larry Suter, and Elizabeth VanderPutten of NSF; Carol Sue Fromboluti and Jill Edwards Stanton of OERI, and Maggie McNeely, formerly of OERI, each played a crucial role in making TIMSS 1999 and the Benchmarking Study possible and for ensuring the quality of the studies. Each participating country was responsible for funding local project costs and implementing TIMSS 1999 in accordance with the international procedures.

Management and Operations

For this *Regional Benchmarking Report*, Steven J. Chrostowski led the TIMSS International Study Center (ISC) effort with strong support from Ina V.S. Mullis, Michael O. Martin, and Eugenio J. Gonzales. Cynthia Tananis led the Math & Science Collaborative (MSC) team comprising Nancy Bunt, Marcia Seeley, and Louis Tamler, with Marjorie Logsdon and Kathleen Ceroni as teacher editors, and Cara Ciminillo as production assistant. The MSC Steering Council offered guidance on all aspects of participation from encouraging involvement to the reporting of results to encourage active response.

TIMSS 1999 was conducted under the auspices of the IEA. TIMSS 1999 was co-directed by Michael O. Martin and Ina V.S. Mullis, and managed centrally by the staff of the International Study Center in the Lynch School of Education at Boston College. Although the study was directed by the International Study Center and its staff members implemented various parts of TIMSS 1999, important activities also were carried out in centers around the world. The IEA Secretariat in Amsterdam was responsible for overseeing fundraising and country participation, and it also coordinated translation verification and recruiting of international quality control monitors. The data were processed centrally by the IEA Data Processing Center in Hamburg. Statistics Canada in Ottawa was responsible for collecting and evaluating the sampling documentation from each country and for calculating the sampling weights. Educational Testing Service (ETS) in Princeton, New Jersey, conducted the scaling of the achievement data.

For the Benchmarking Study, Westat in Rockville, Maryland, was responsible for sampling, data collection activities, and preliminary data processing. National Computer Systems (NCS) in Iowa City, Iowa, conducted the scoring for Benchmarking jurisdictions along with the national scoring effort. All data were processed in accordance with international standards at the IEA Data Processing Center. Scaling of the achievement data was conducted by Educational Testing Service.

In 1998-99, Cynthia Tananis and Nancy Bunt shared coordination of the administration of TIMSS in Southwest Pennsylvania. They were responsible for obtaining funding for the project; obtaining cooperation of sampled schools, classes, and students; and responding to curriculum questionnaires. The Education Policy and Issues Center's Karen McIntyre worked with them and Emily Watson of The Grable Foundation to develop a brochure to promote participation in the international study among the randomly selected schools. Civic and educational leaders volunteered quotes for use in the brochure. Intermediate Units 1, 3, 27, and 28 hosted meetings for superintendents to inform them of the benefits of participation. Special mention is due the Carnegie Science Center, which hosted a thank you dinner and Omnimax showing for sampled educators. And kudos are due Emily Watson, who arranged for motivational speakers and pizza parties to help eighth graders know why their careful work on this "test without a grade" was important to the region. In 2000, Louis Tamler and Marcia Seeley joined the Math & Science Collaborative team as they undertook reviewing data; contributing to the development of the Benchmarking reports; and

coordinating activities with the International Study Center. McDonalds Corporation's public relations consultant, Kerry Ford, worked with Dan Langiovane of Carnegie Museum of Natural History to handle all logistics in hosting the press conference to announce the Benchmarking results.

Contact information for each participant in TIMSS 1999 and the Benchmarking Study is included in the full Benchmarking reports, available at <http://timss.bc.edu>.

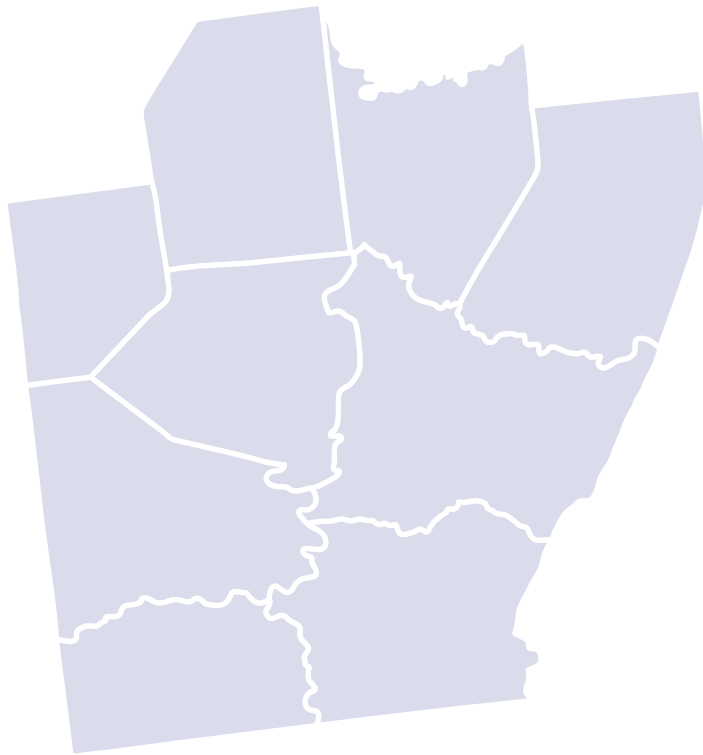

This book was set in ITC Officina Sans and Serif, designed by Erik Spiekermann.



Classroom illustration provided by Artville, Inc.

Maps and globe provided by Cartesia, Inc.

Cover and Book Design: José R. Nieto

Layout and Production: Susan L. Messner

The front cover represents a polar perspective of the earth. This perspective provides a slightly different context for viewing the world, the US and our region, perhaps even one that looks slightly “new” (the point of the arrow is, in fact, placed accurately for Southwest Pennsylvania). We use this graphic in part to encourage a fresh perspective on mathematics and science education for our region, via the lens TIMSS Benchmarking provides.

